

Artemide®

Incalmo / Incipit / Invero 214

design
C. de Bevilacqua

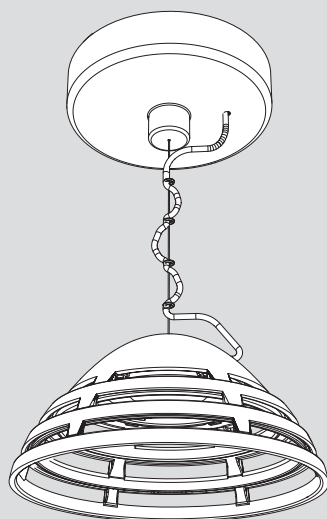

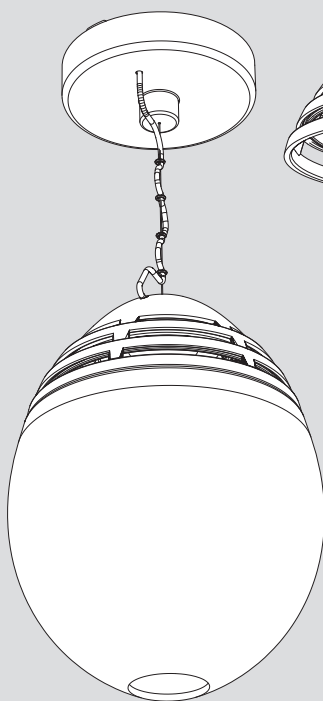
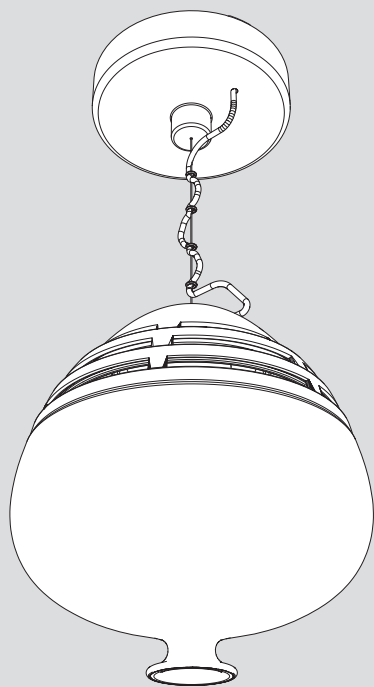

i

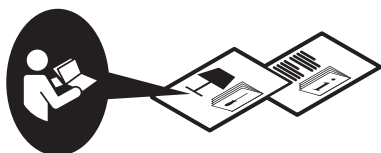
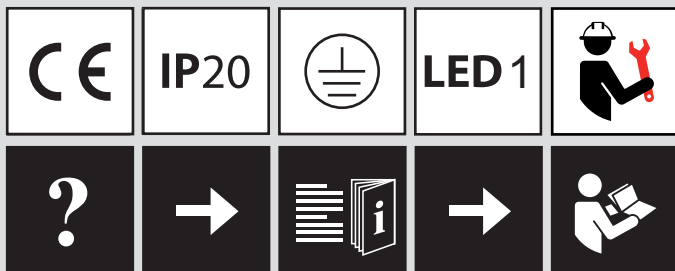

INVERO

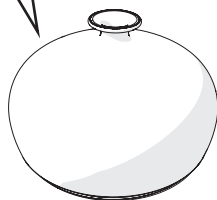

INCALMO

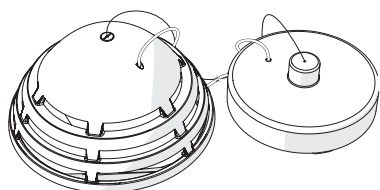
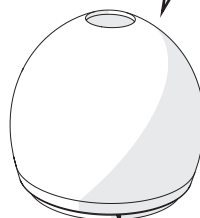

1

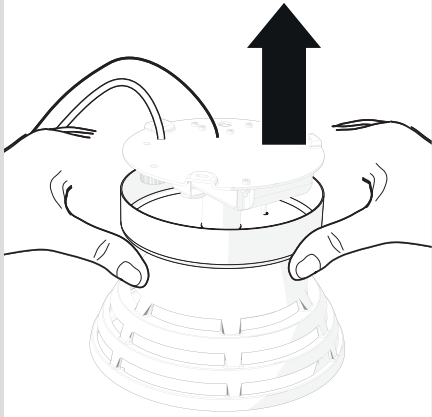

2

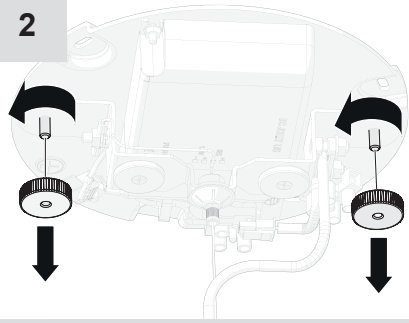

3

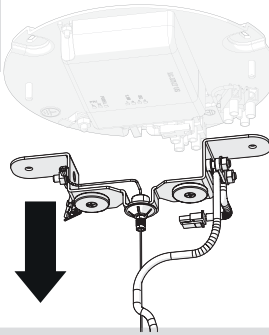

4

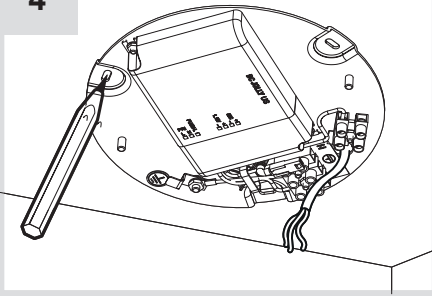

5

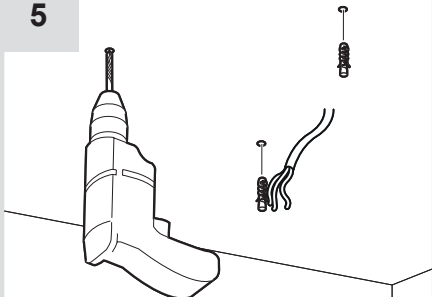

6

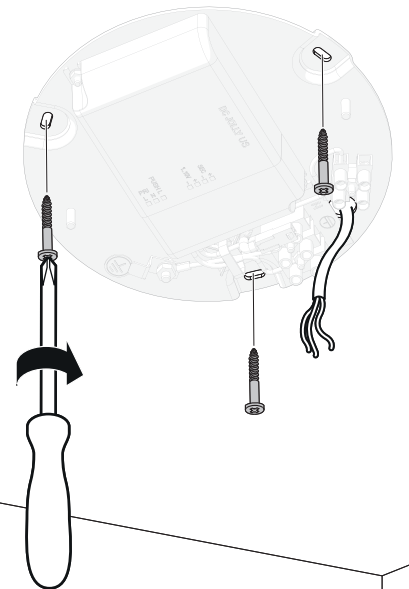

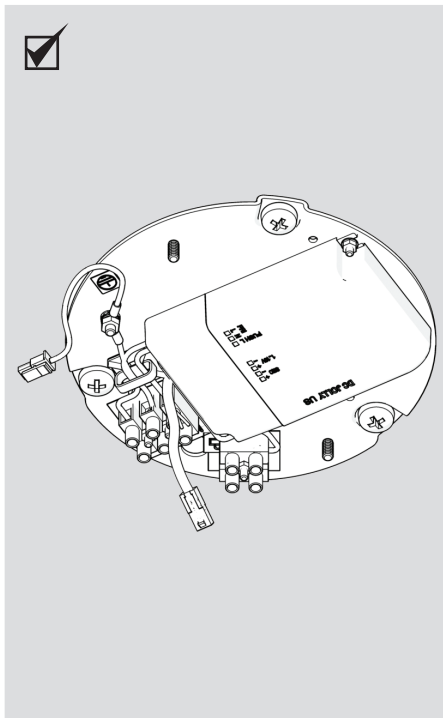
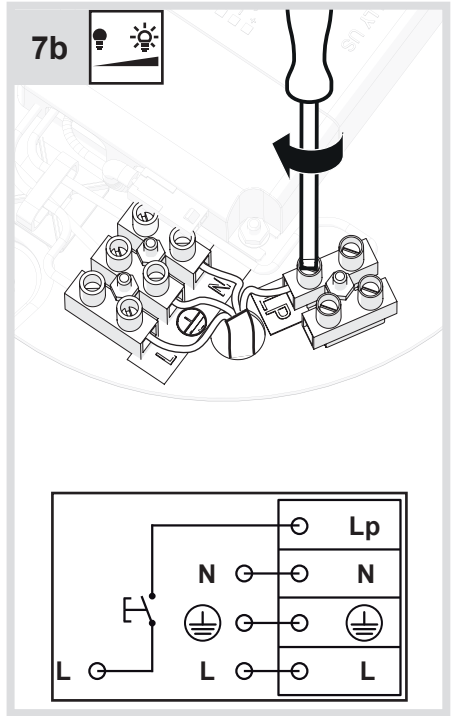
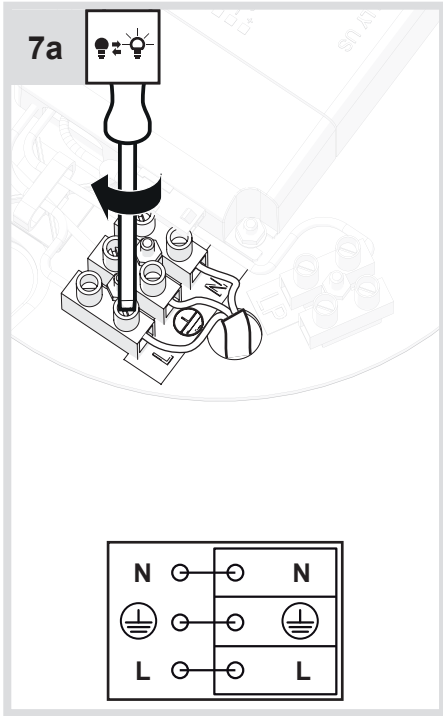

8

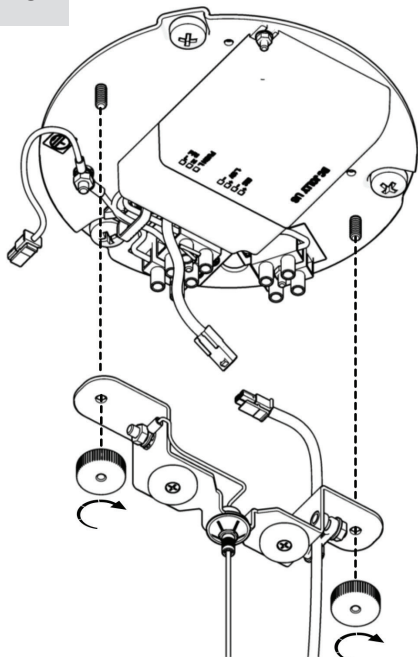

9

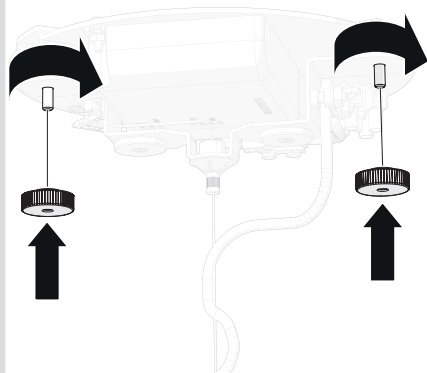

10

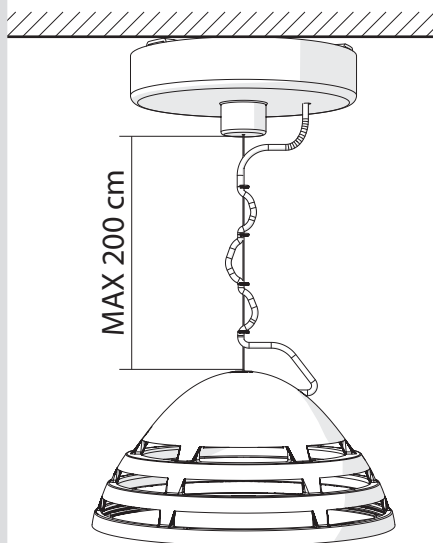
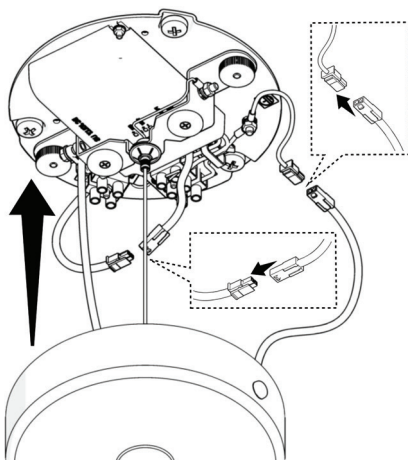

11

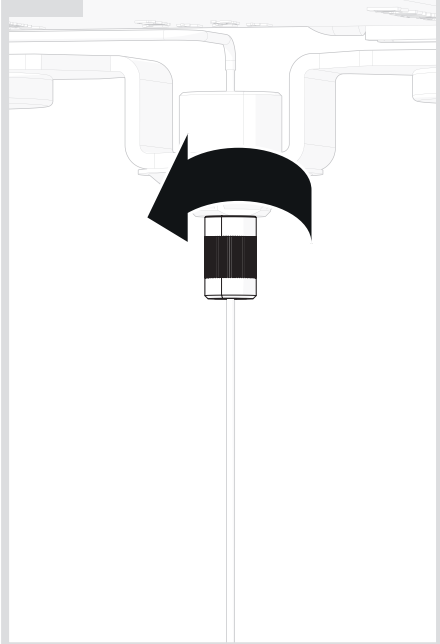

12

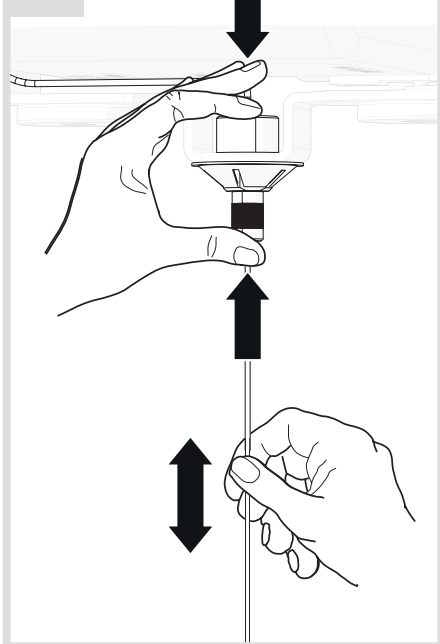

13

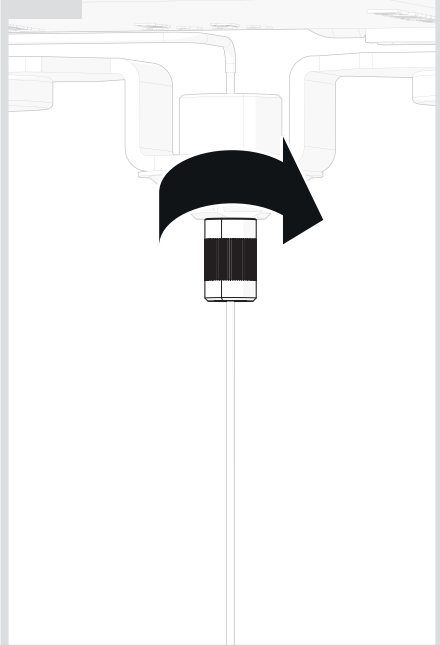

14

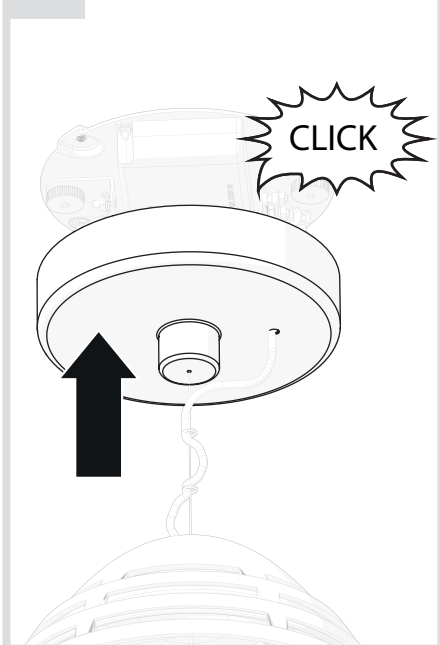

15

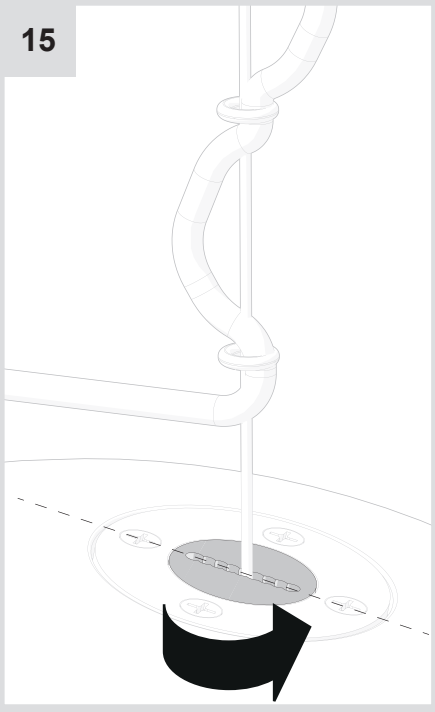

16

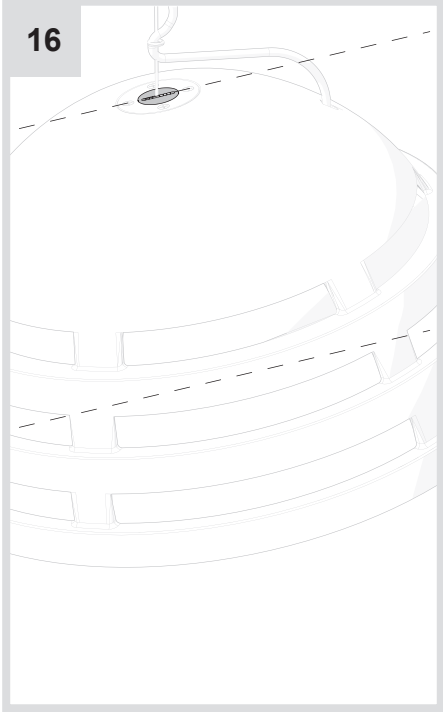

17

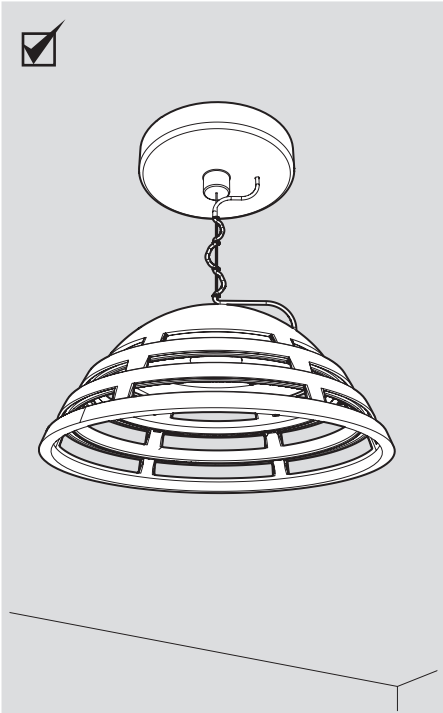
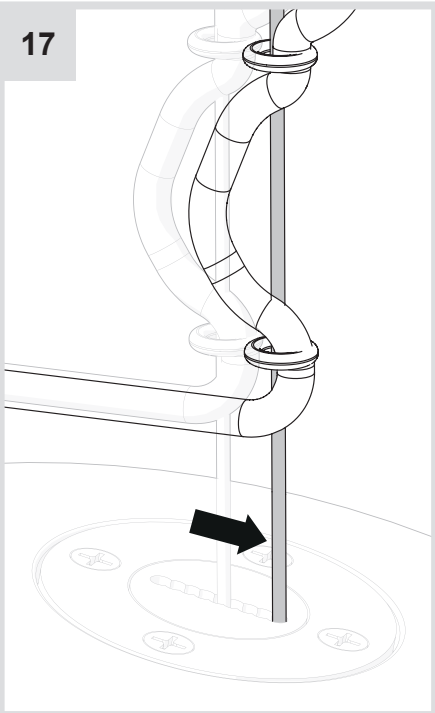

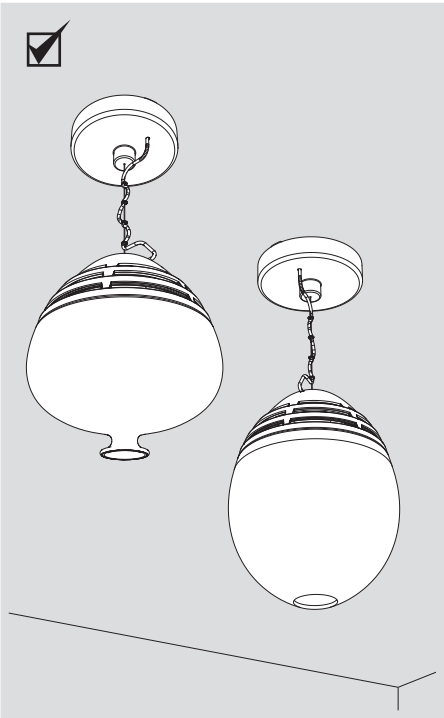
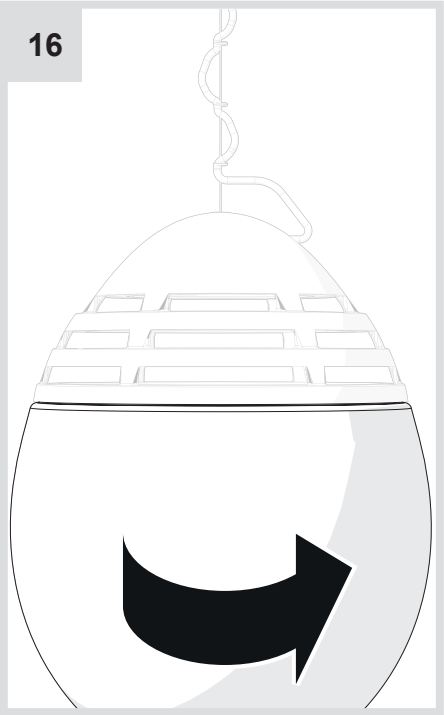
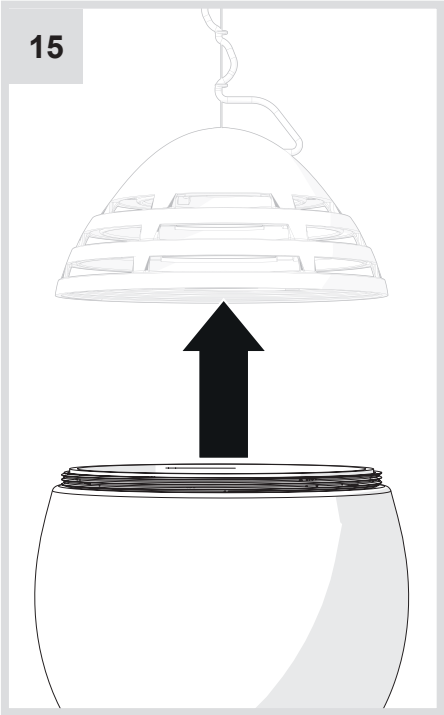

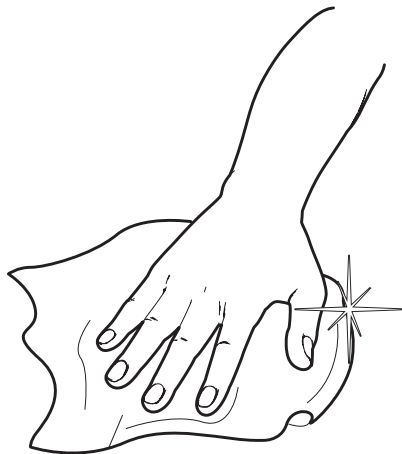
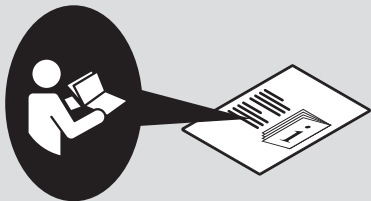

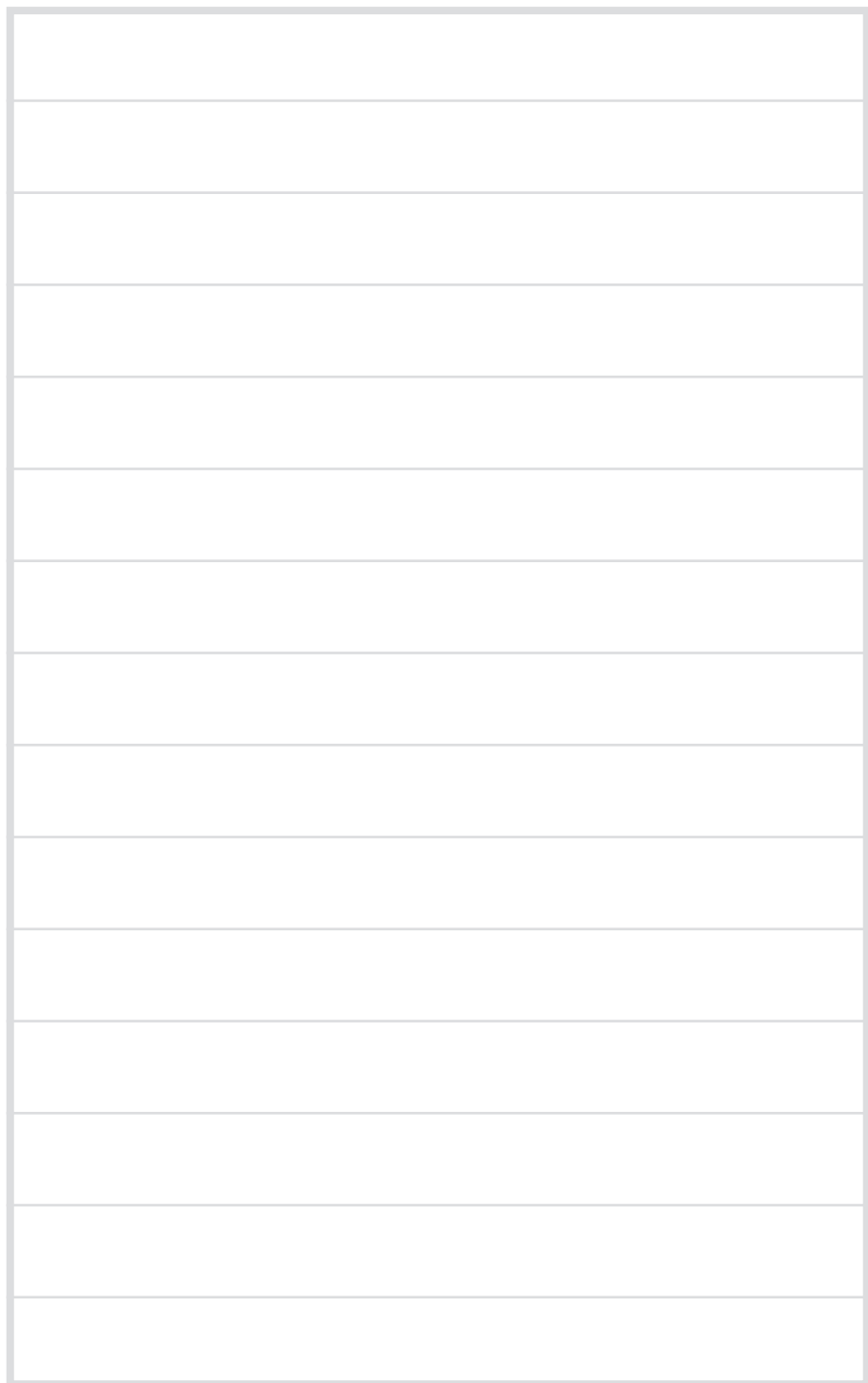

Artemide[®]
ARCHITECTURAL



Artemide

via Bergamo, 18
20010 Pregnana M.se (MI)
ITALIA

tel. +39 02 935 181
fax +39 02 935 90 254
fax +39 02 935 90 496

www.artemide.com

VAT IT00846890150

cod. Y513000451A