

Look at me 21 track
Look at me 35 track

Look at me 21 track s.
Look at me 35 track s.

design
Silvio De Ponte
Alida Catella

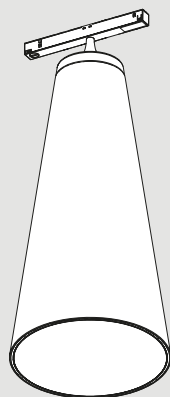

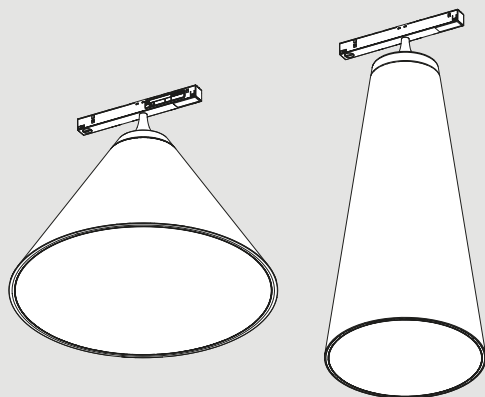
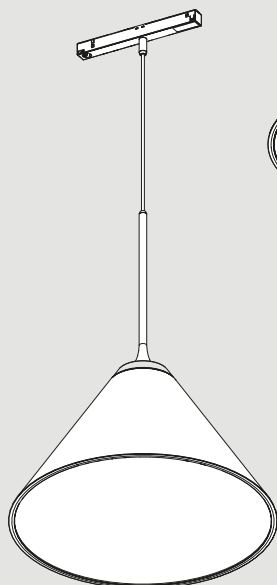
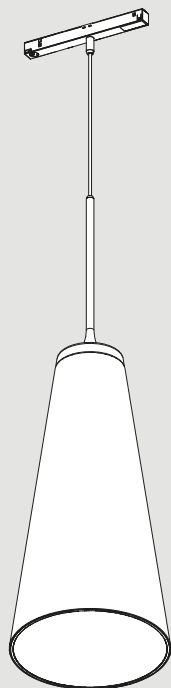

i

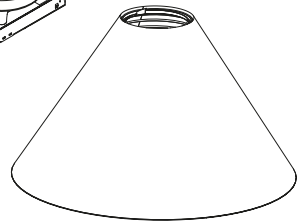
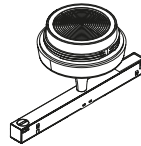
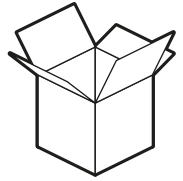
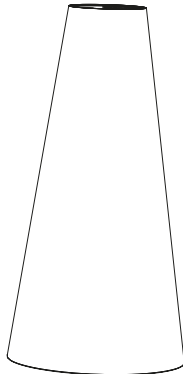
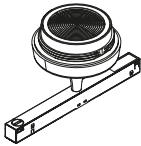
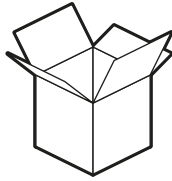
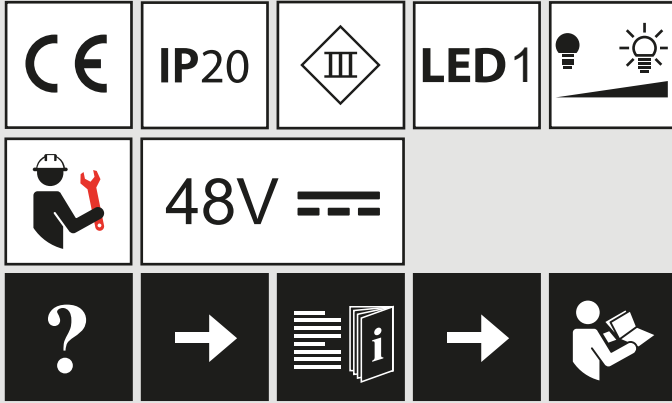

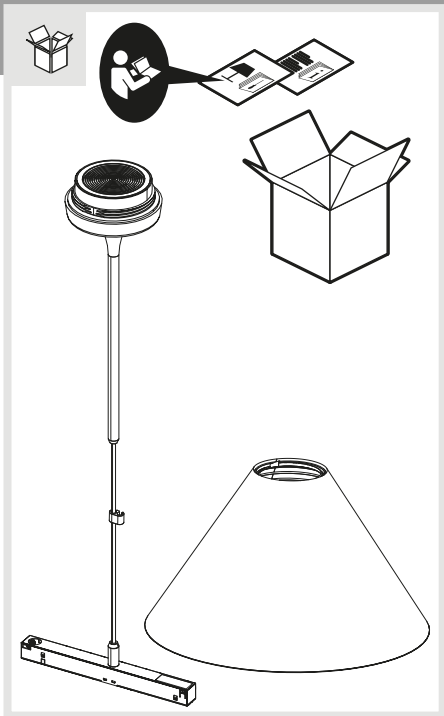
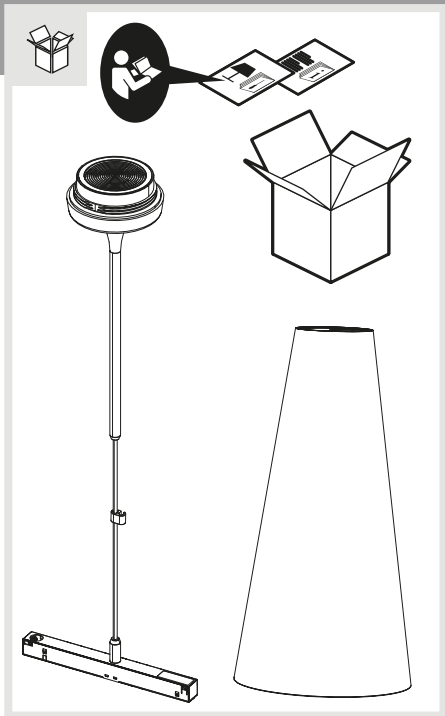

i

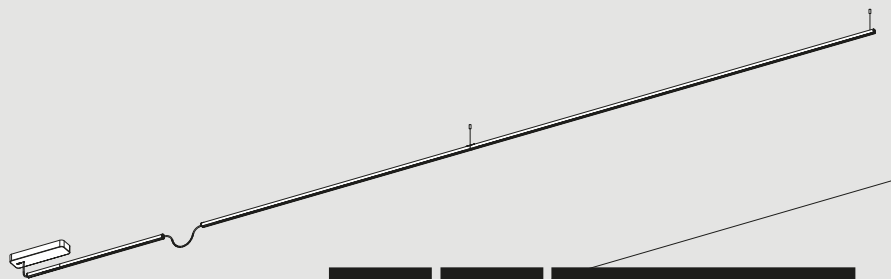

Y513001184

1

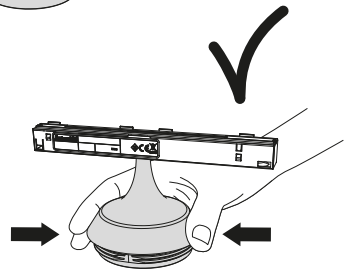
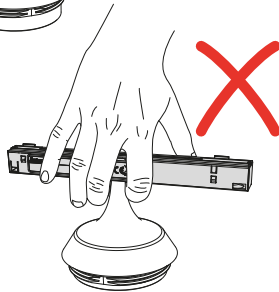
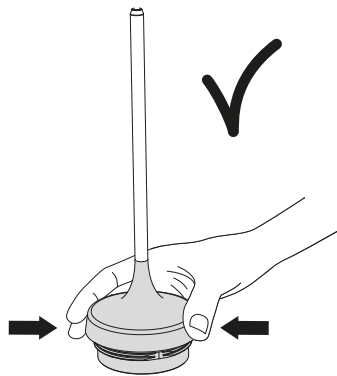
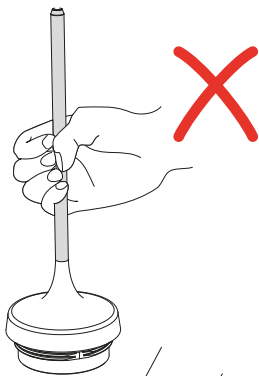
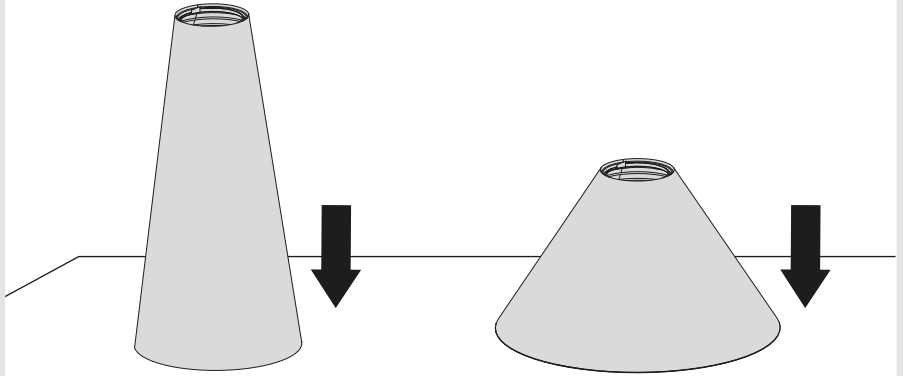

2

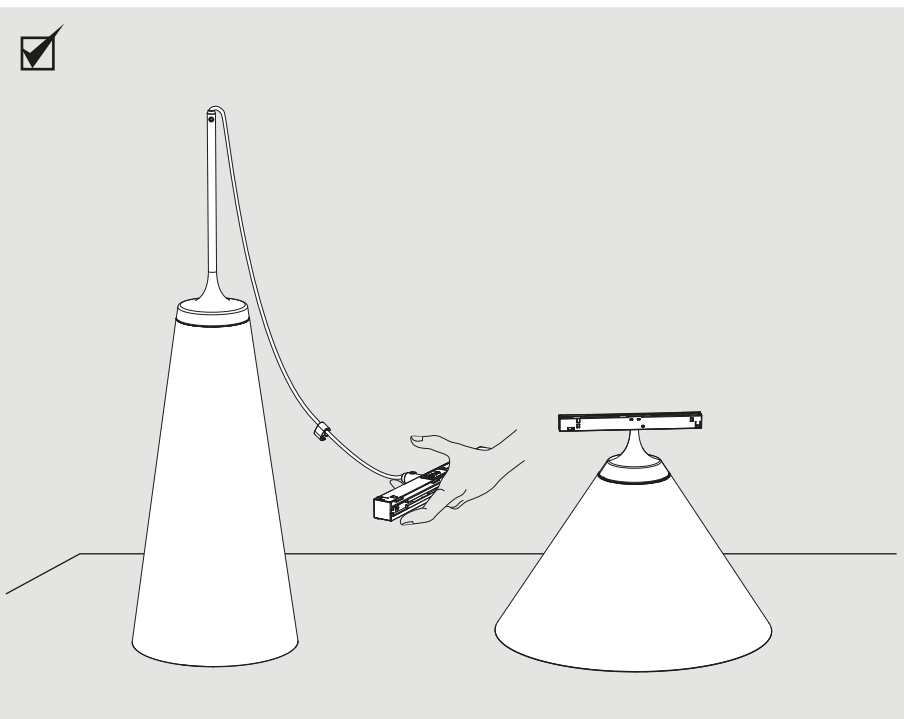
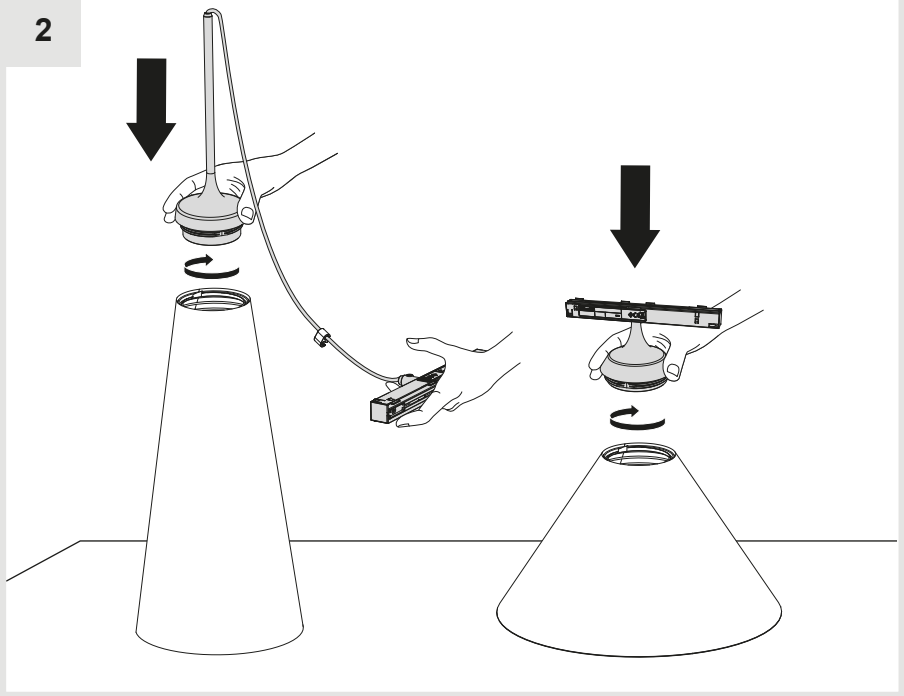

i

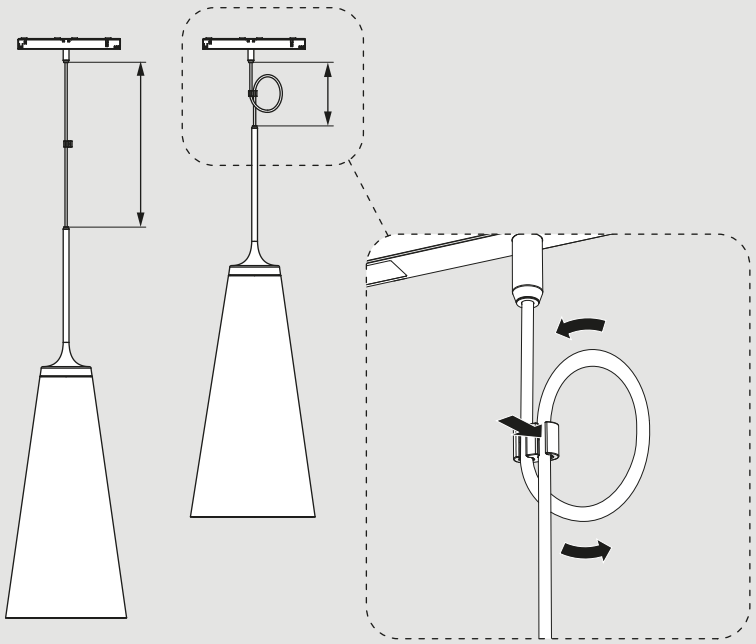

3

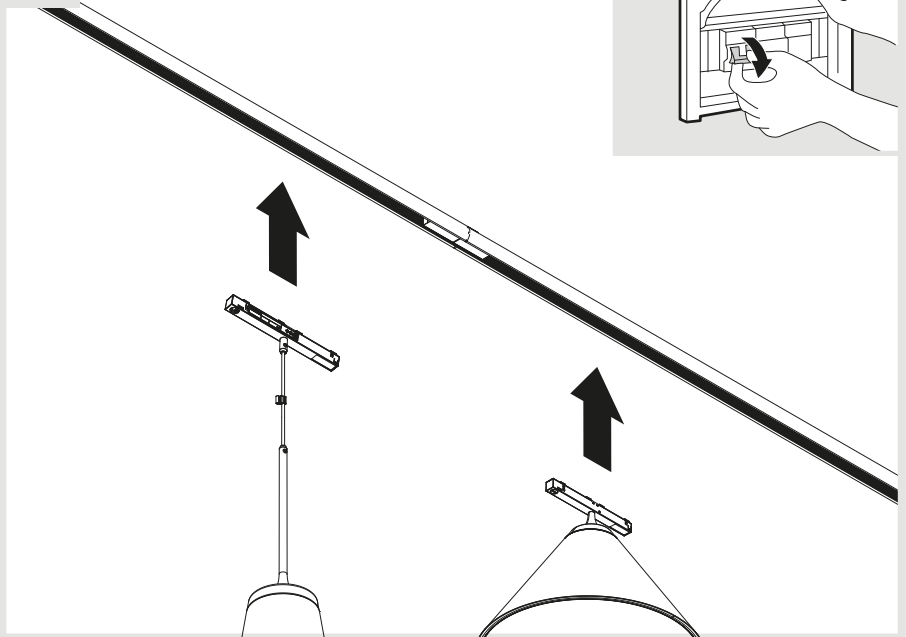

4

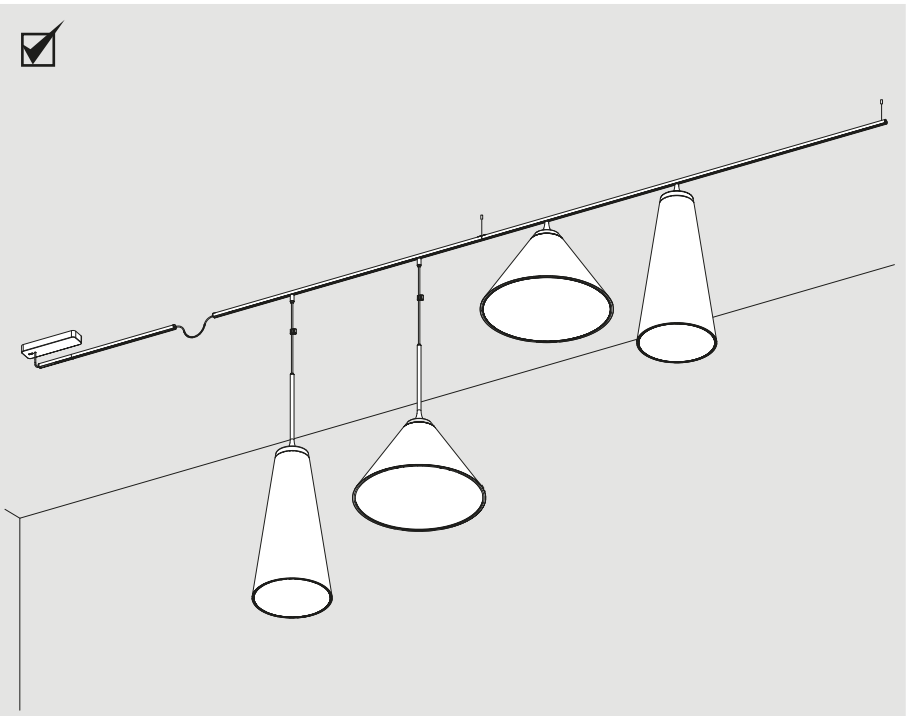
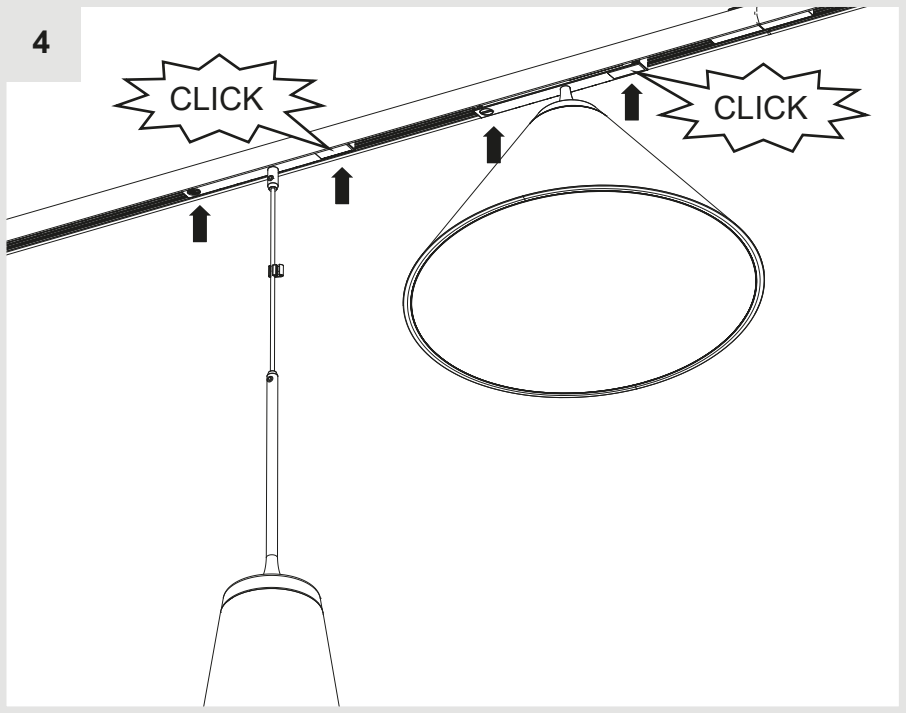



i

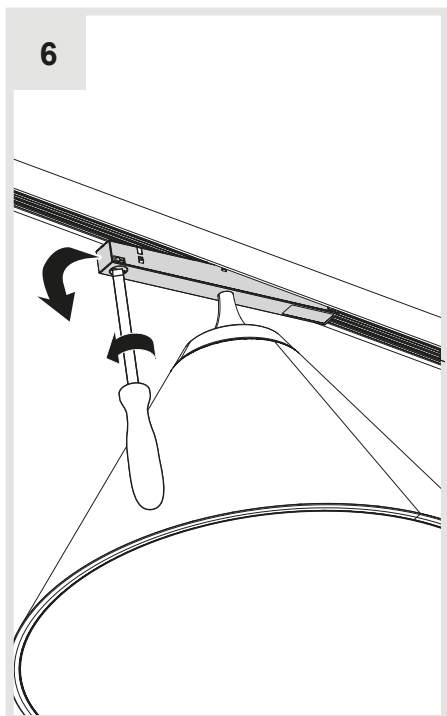
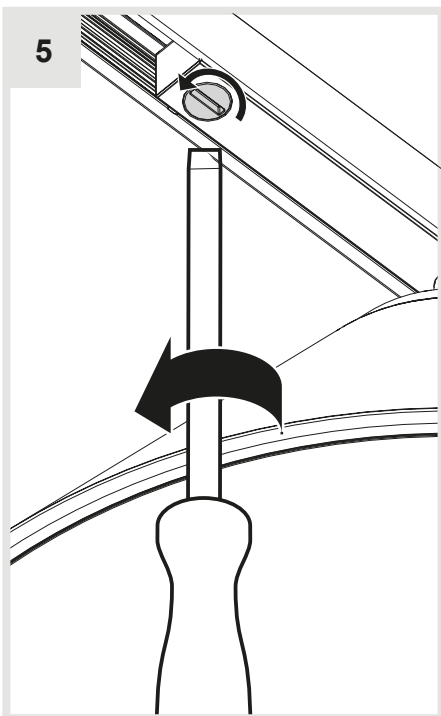
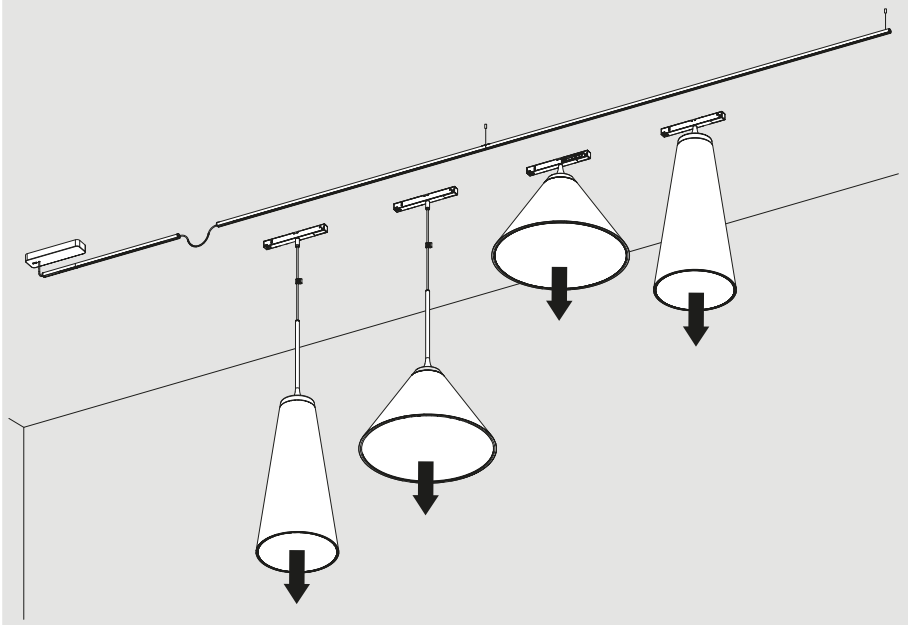

7

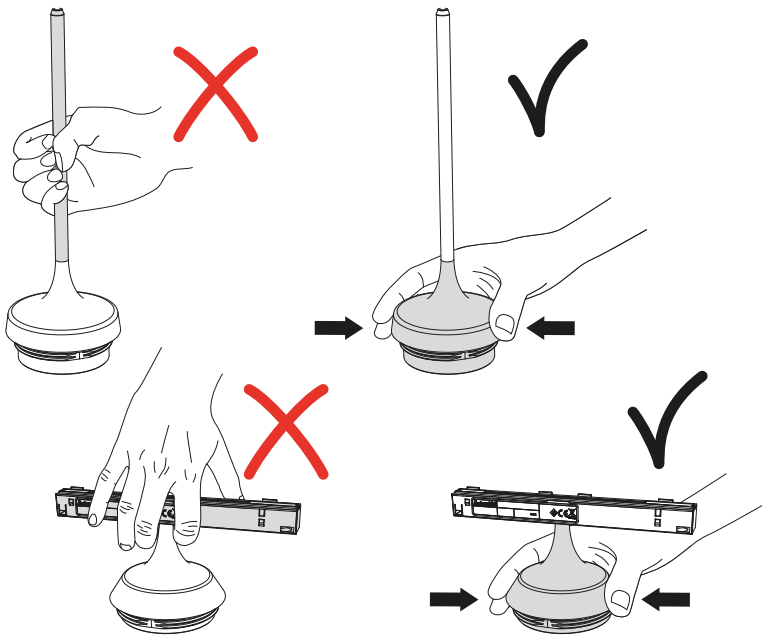
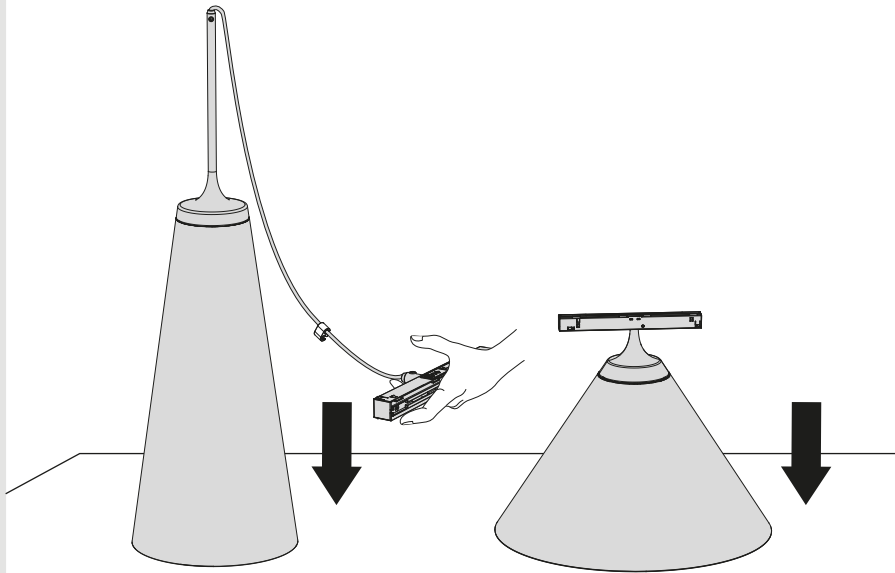

8

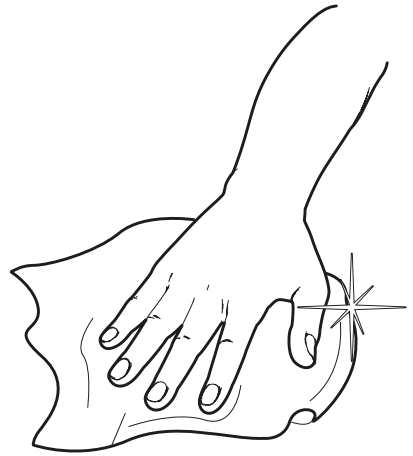
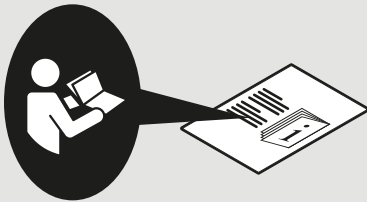
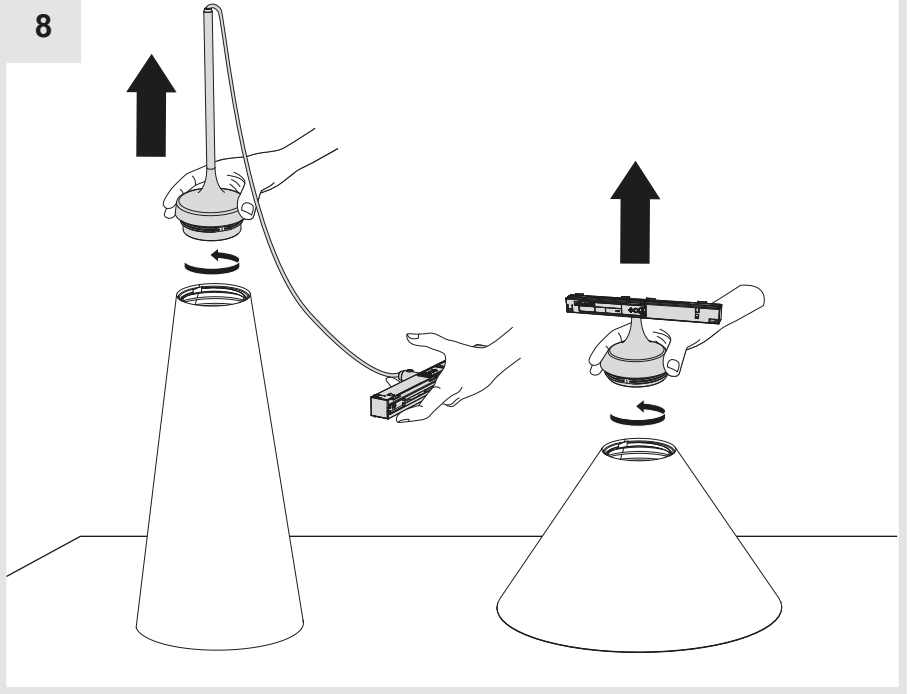

Artemide®

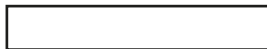

Artemide

via Bergamo, 18
20010 Pregnana M.se (MI)
ITALIA

tel. +39 02 935 181
fax +39 02 935 90 254
fax +39 02 935 90 496

www.artemide.com

VAT IT00846890150

cod. Y513001183B