

Artemide®

Choose

design
M. Thun

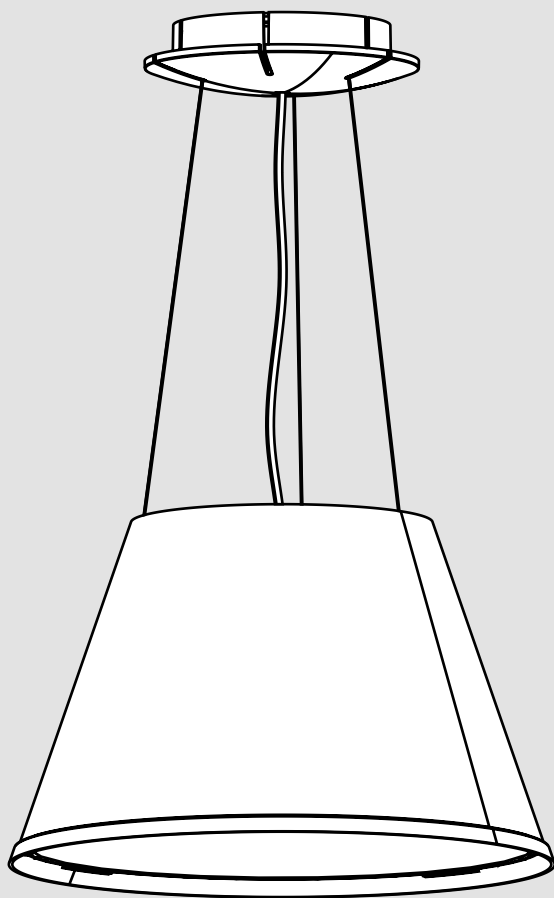

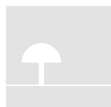

i

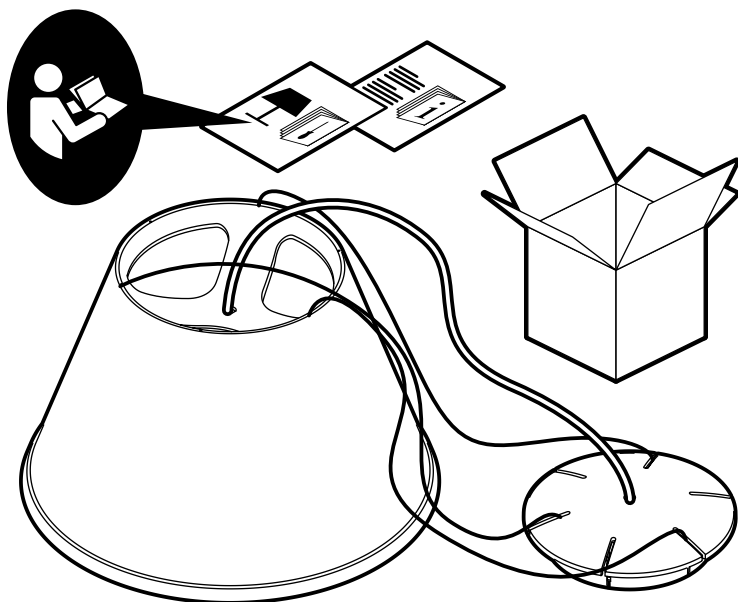
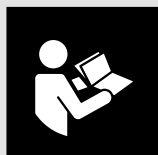
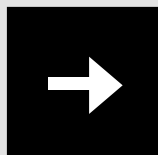
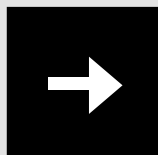
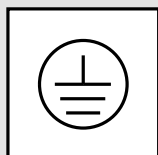
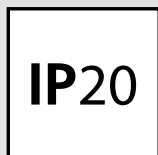
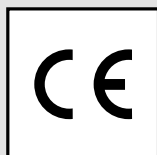

1

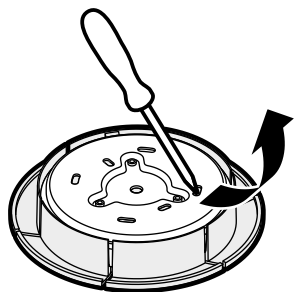

2

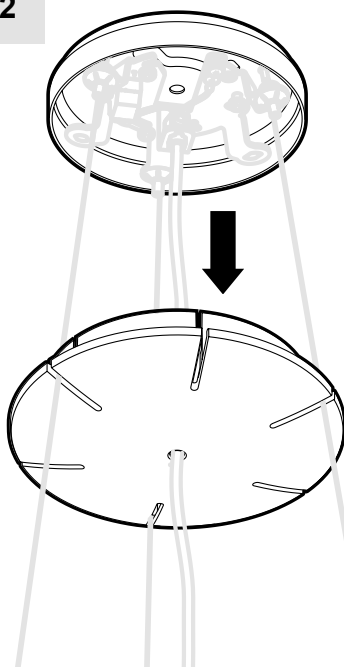

3

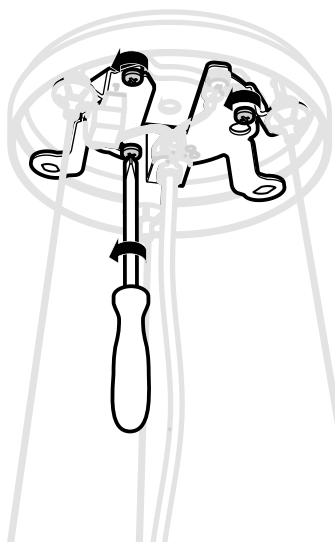

4

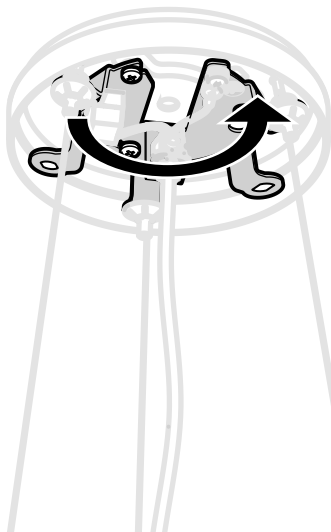

5

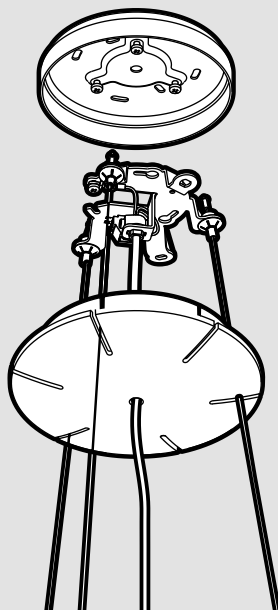
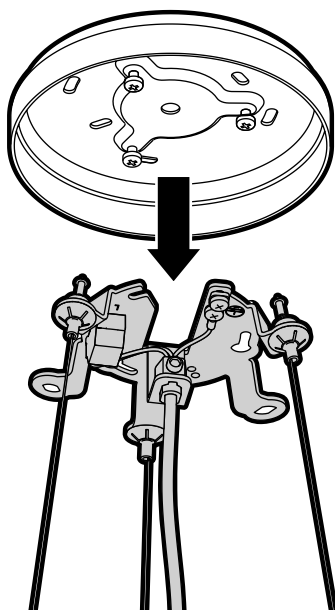

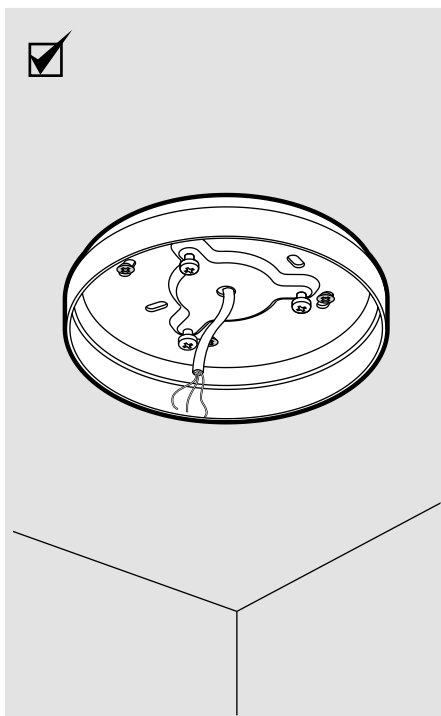
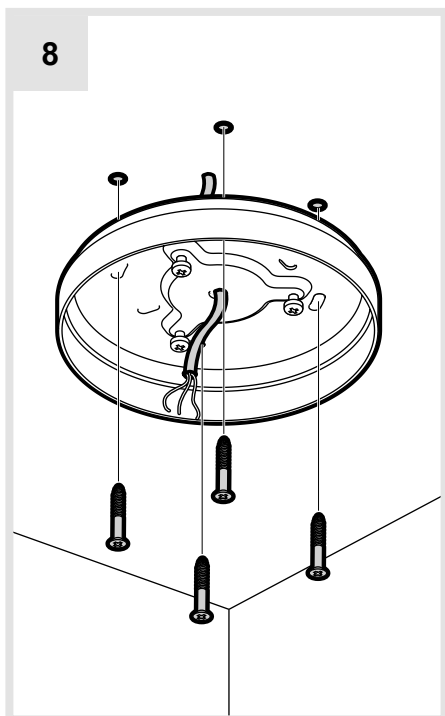
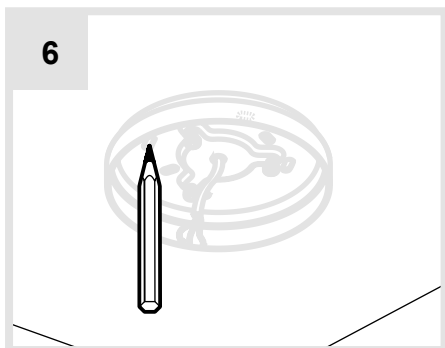
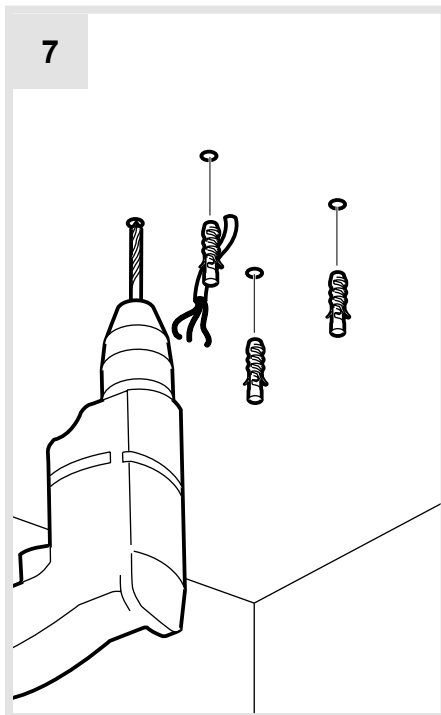
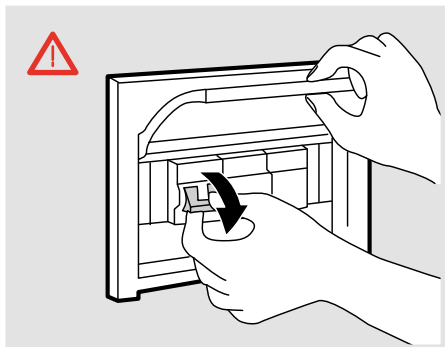

i

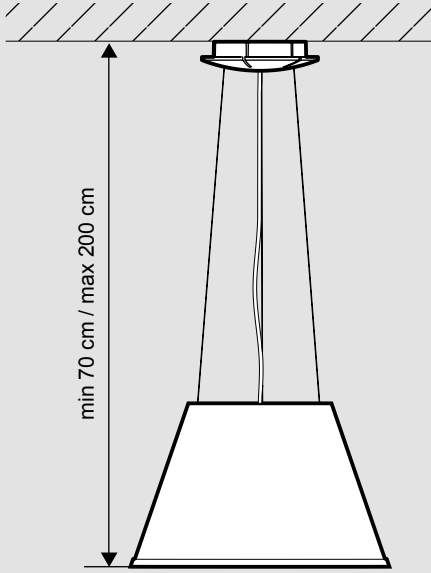

9

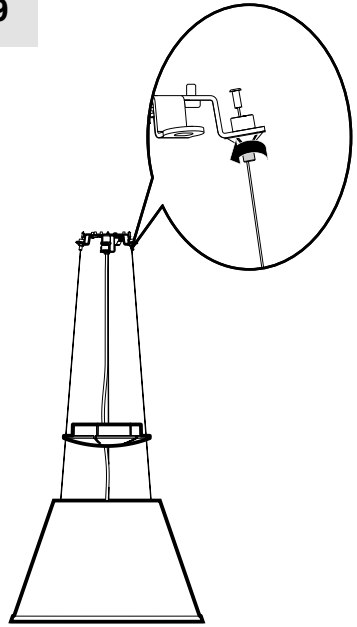

10

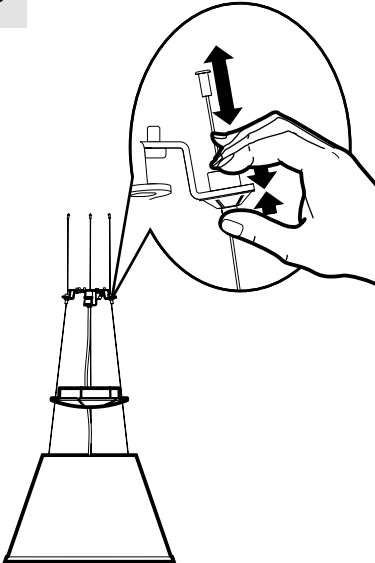

11

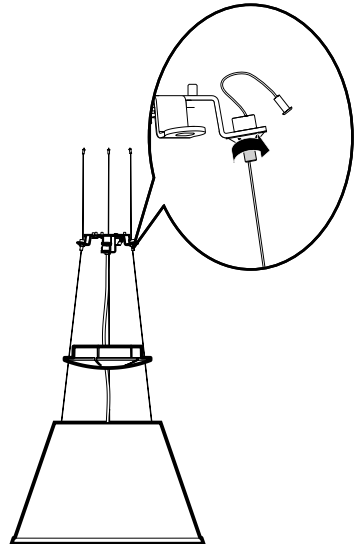

12

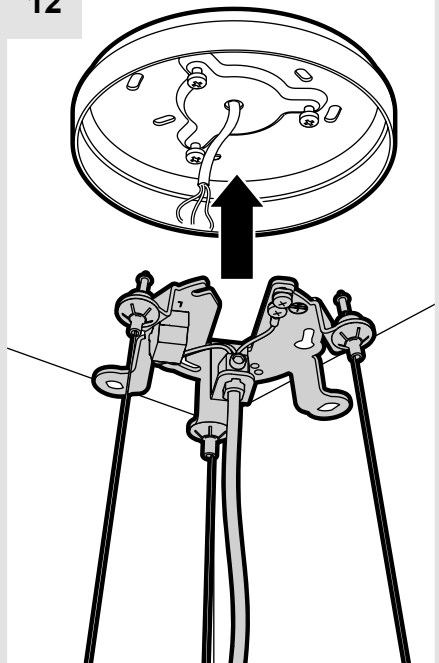

13

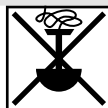

14

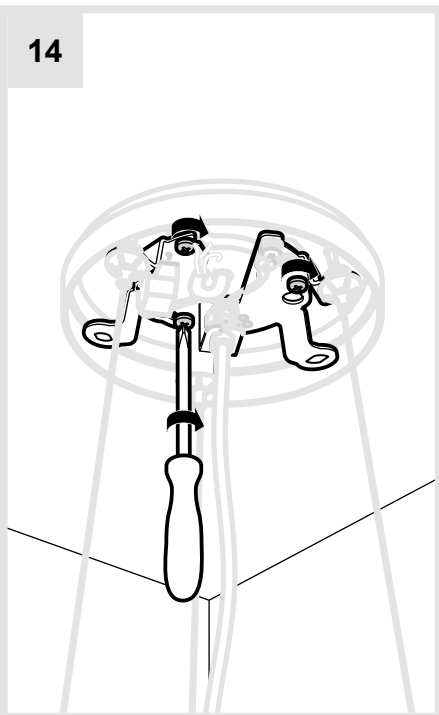

15

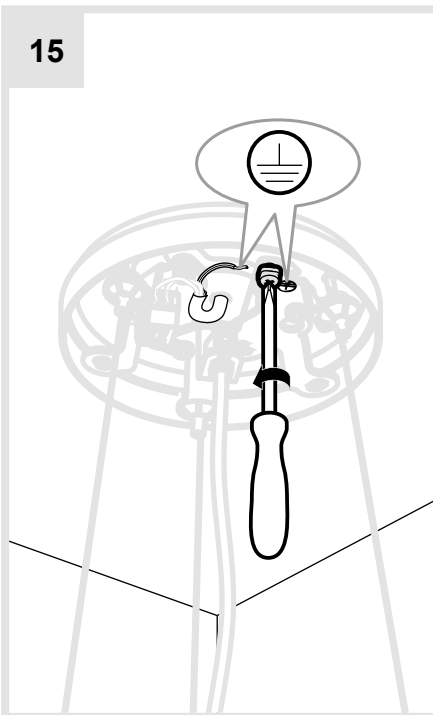

16

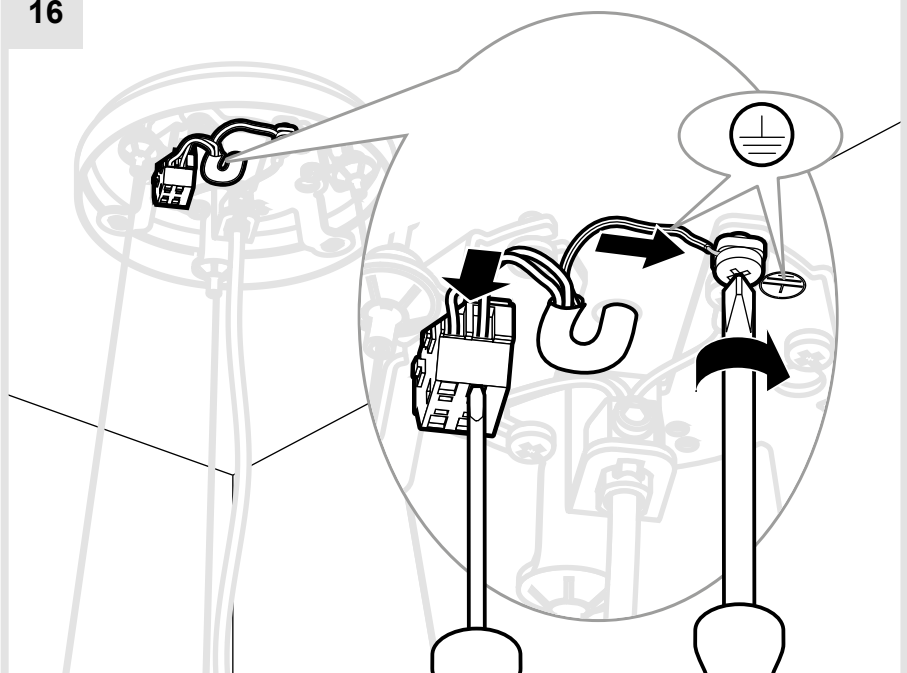

17

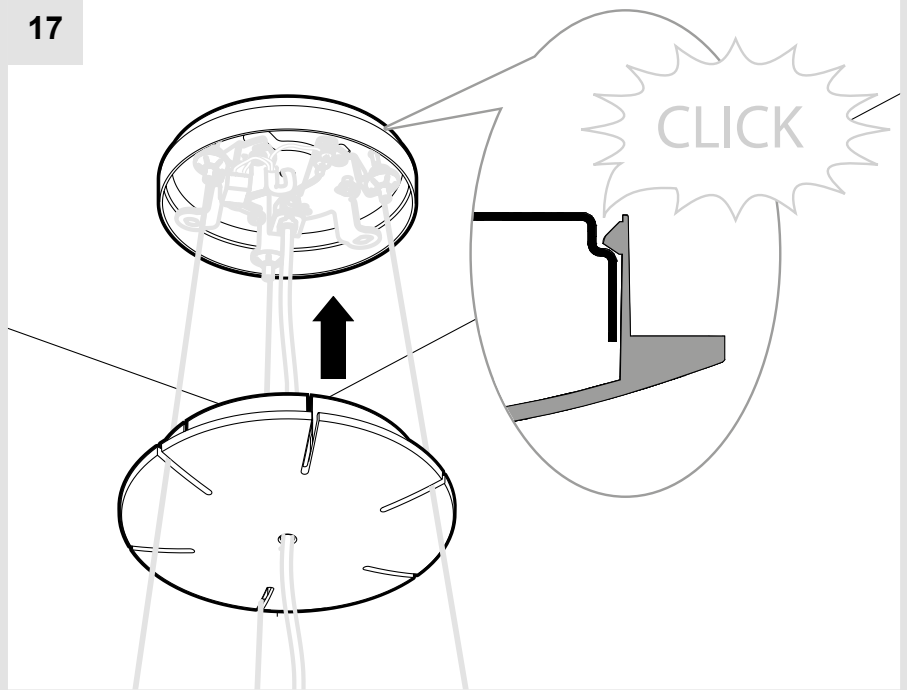

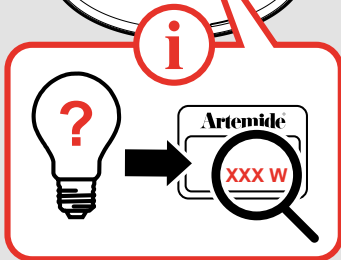
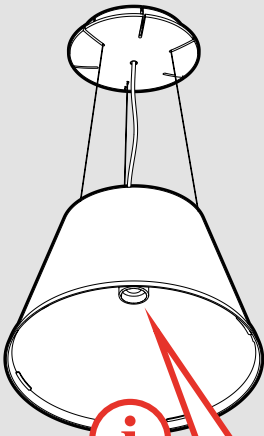
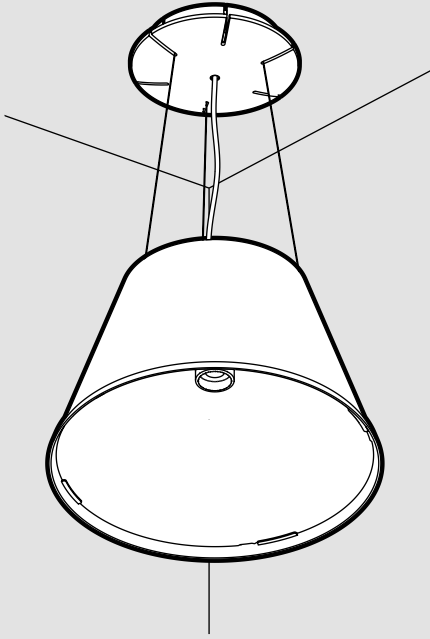

1

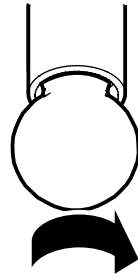
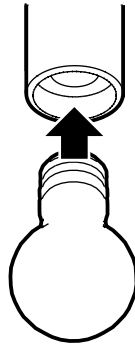



i



1

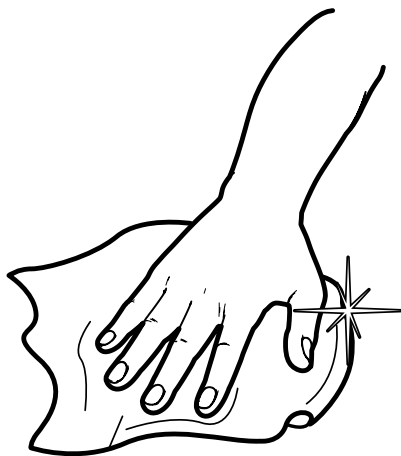

1

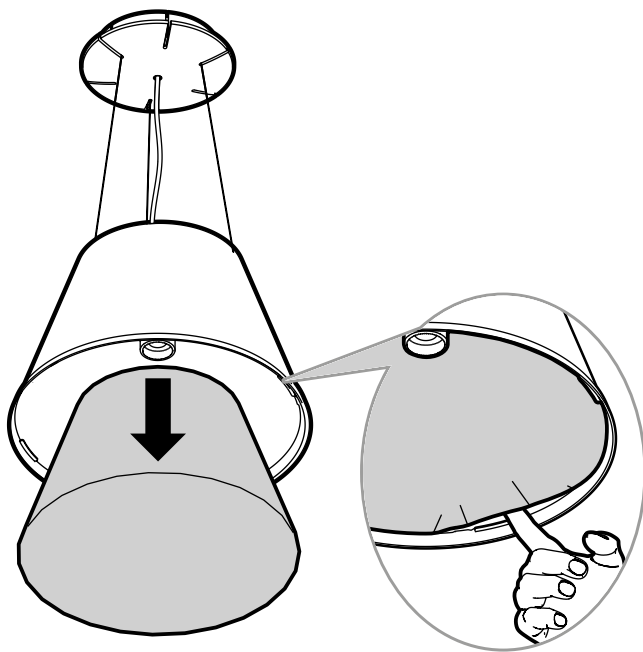

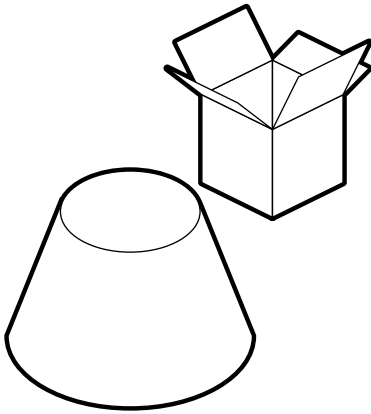

2

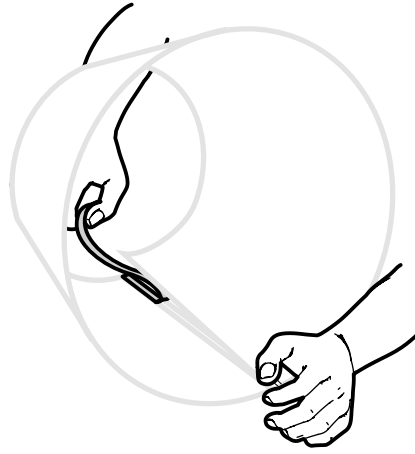

3

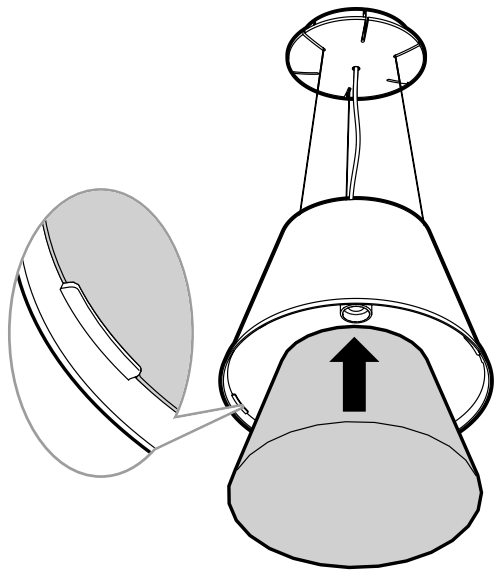

Artemide®

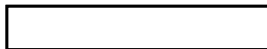

Artemide

via Bergamo, 18
20006 Pregnana M.se (MI)
ITALIA

tel. +39 02 935 181
fax +39 02 935 90 254
fax +39 02 935 90 496

www.artemide.com

VAT IT00846890150

cod. Y51300001D