

Empatia 26 / 36

design

C. de Bevilacqua - P. di Arianello

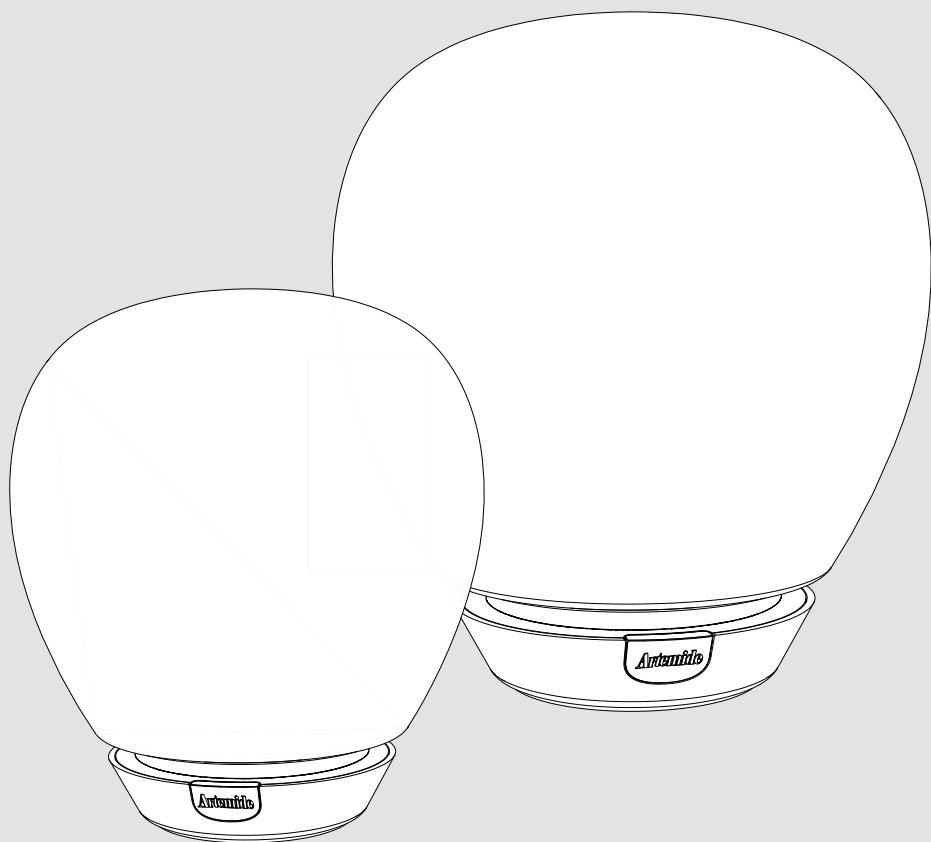



i

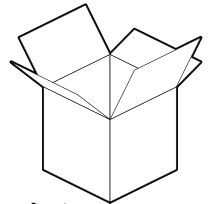
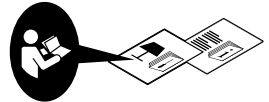
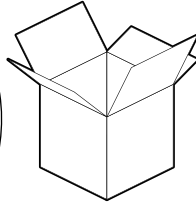
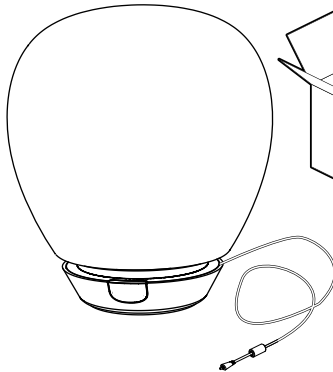
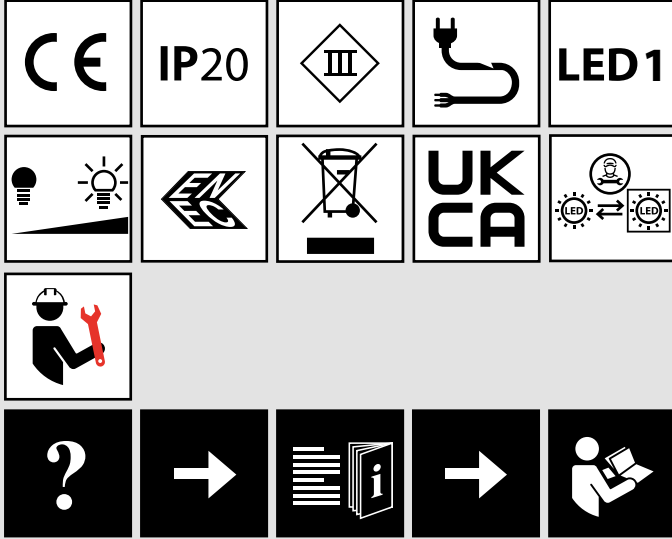

EU market only

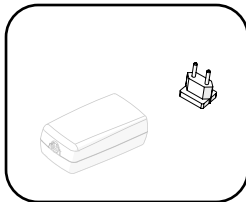

worldwide market

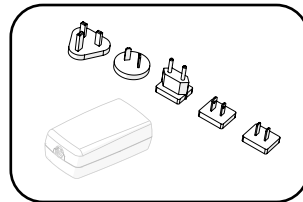

or

1

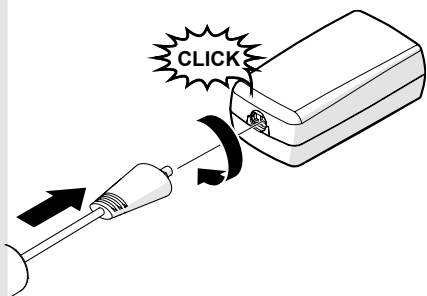

i EU market only

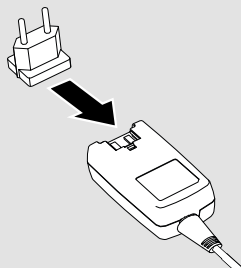

i worldwide market

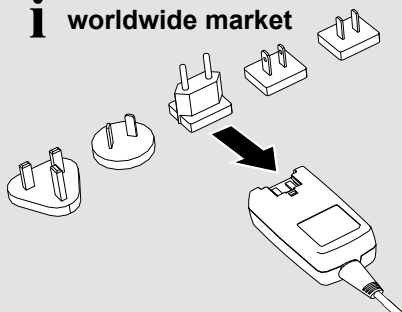

2

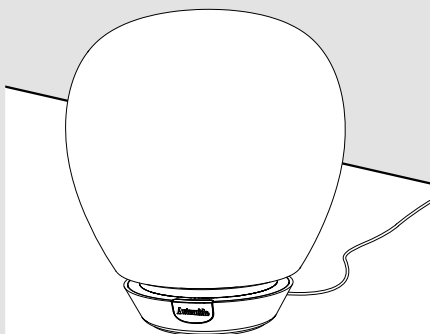
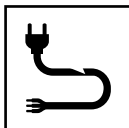
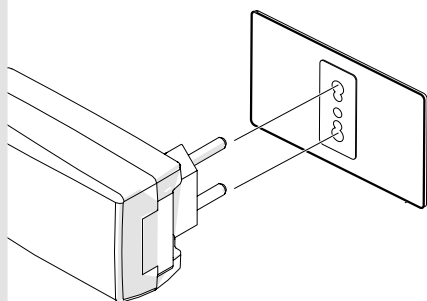



1

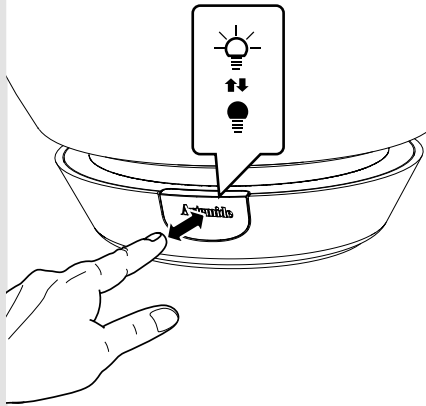

2

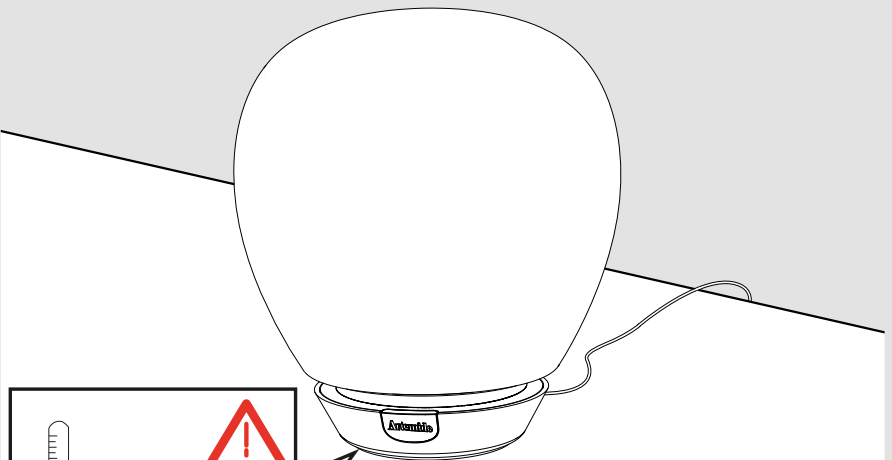
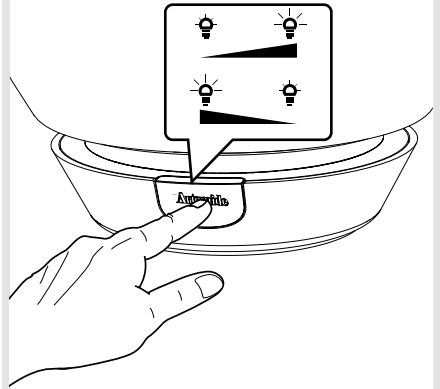

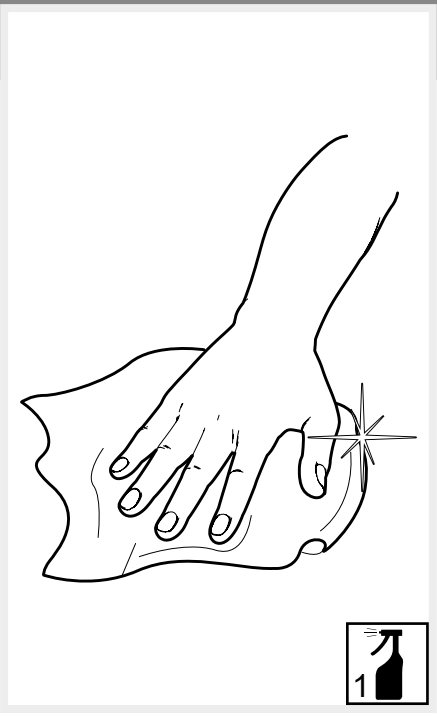

Artemide®

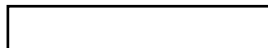

Artemide

via Bergamo, 18
20006 Pregnana M.se (MI)
ITALIA

tel. +39 02 935 181
fax +39 02 935 90 254
fax +39 02 935 90 496

www.artemide.com

VAT IT00846890150

cod. Y513000182D