

Artemide®

NIDO PER NEEDOO

design
Davide Oppizzi

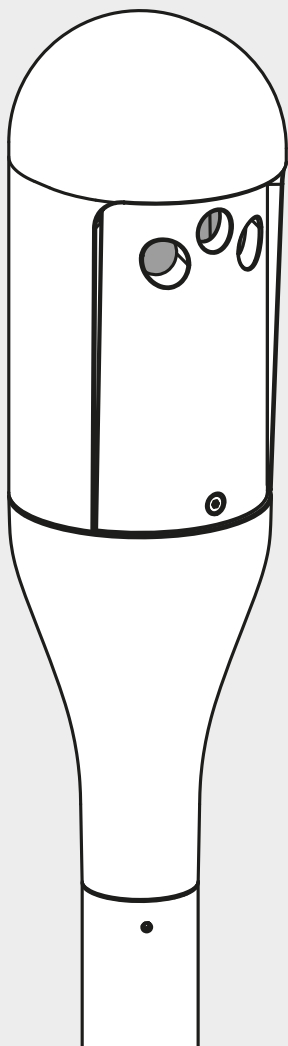



i

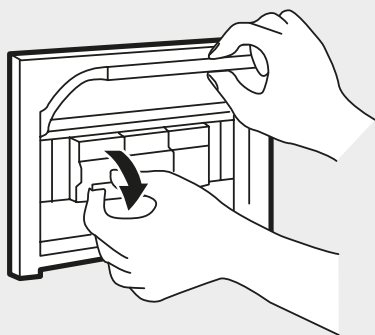
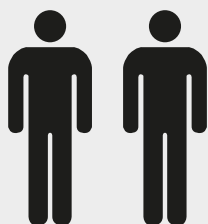
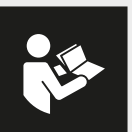

Y513001447

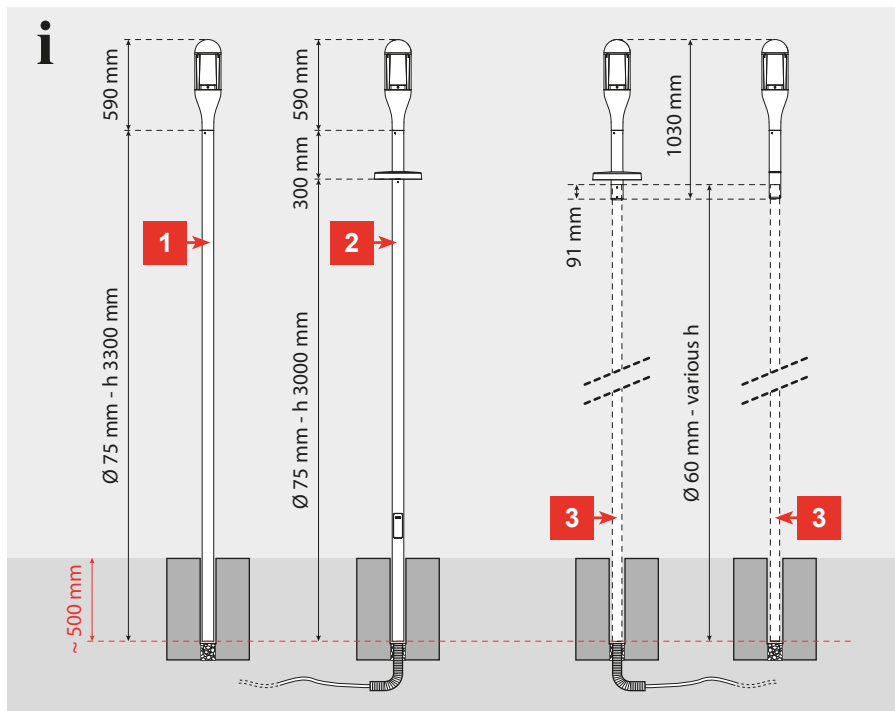

i

POLE	CODES
1 h 3300 mm - Ø 75 mm	T031300 / T031310
2 h 3000 mm - Ø 75 mm	T031200 / T031210
3 various h - Ø 60 mm	commerciale da acquistare separatamente commercial to be purchased separately commercial à acheter séparément comercial que se adquire por separado separat zu erwerbender Werbespot

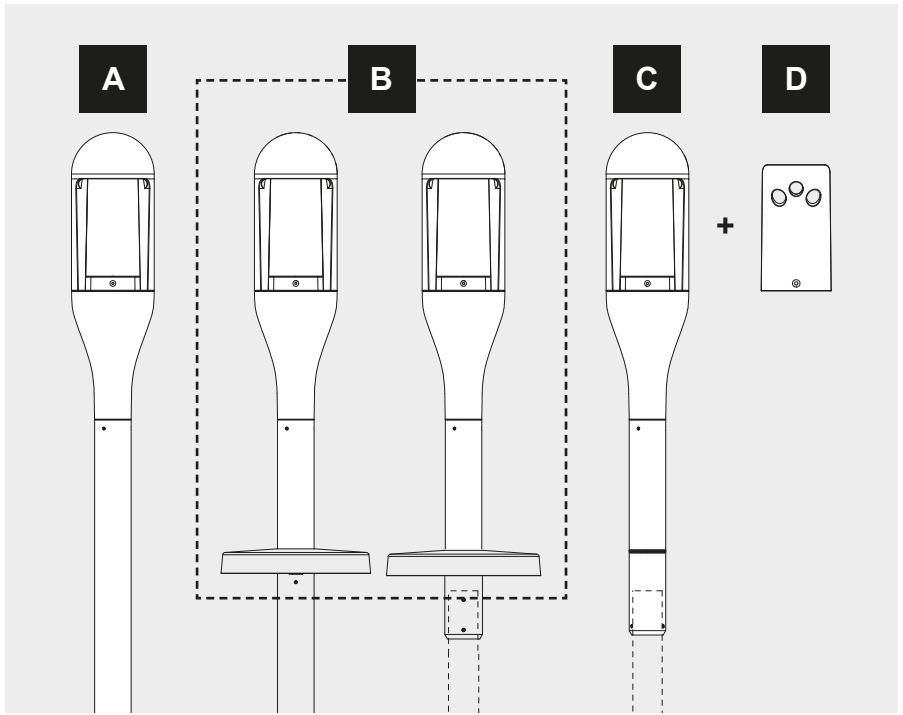

A

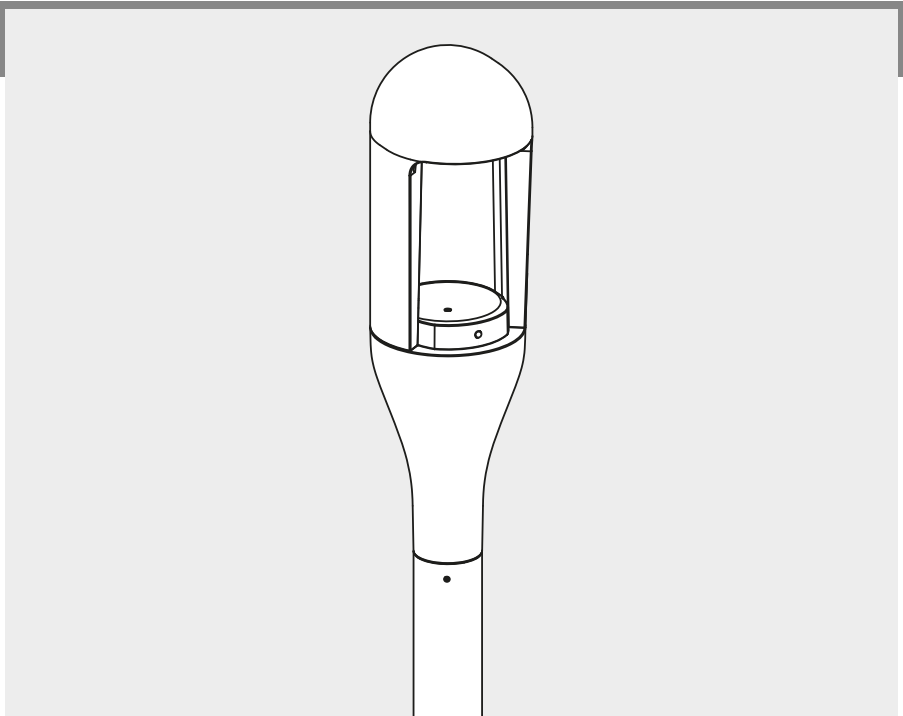

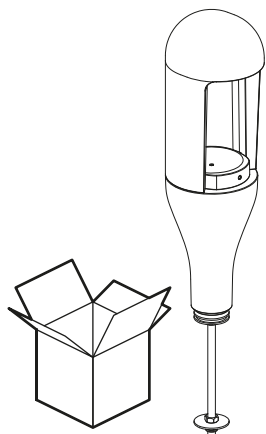
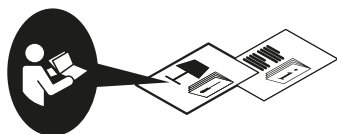

h 3300 mm
Ø 75 mm

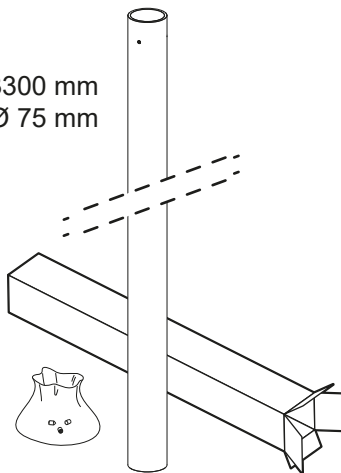

i

Only for T031300 / T031310

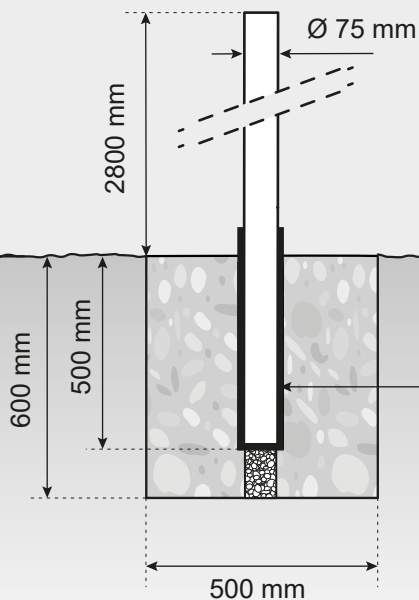

Palo in alluminio: si consiglia rivestimento anti corrosione

Aluminium pole: corrosion-resistant coating recommended

Poteau en aluminium : revêtement anticorrosion recommandé

Poste de aluminio: se recomienda un revestimiento anticorrosivo

Aluminiummast: Korrosionsschutzbeschichtung empfohlen

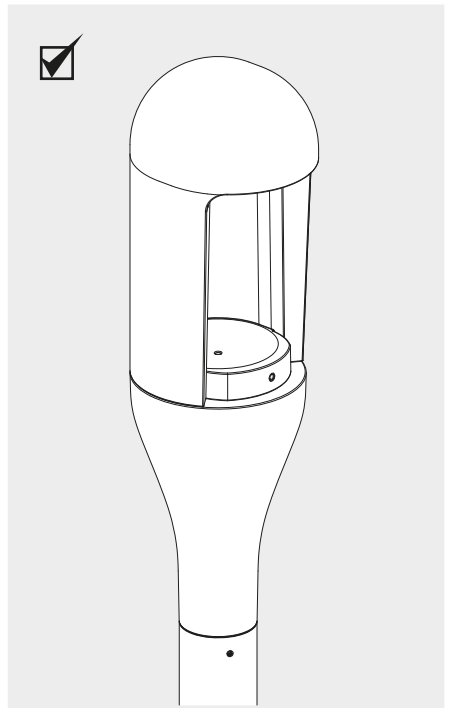
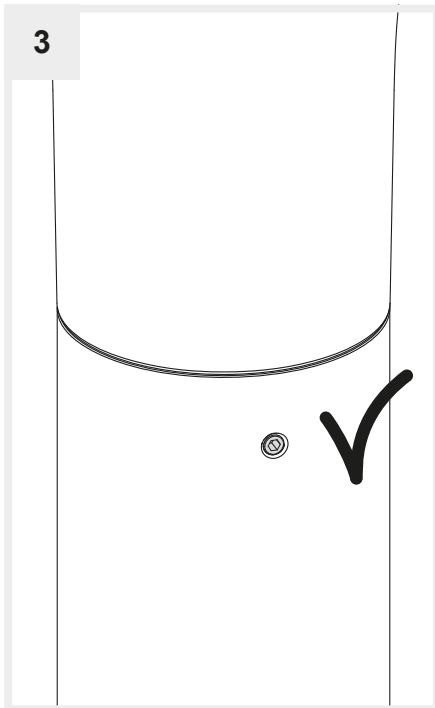
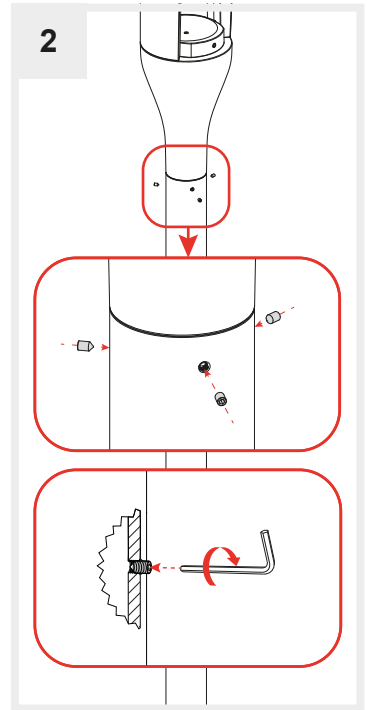
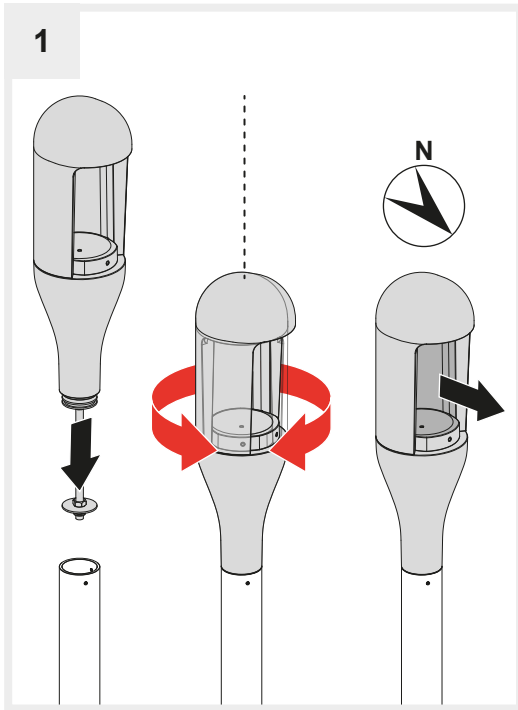

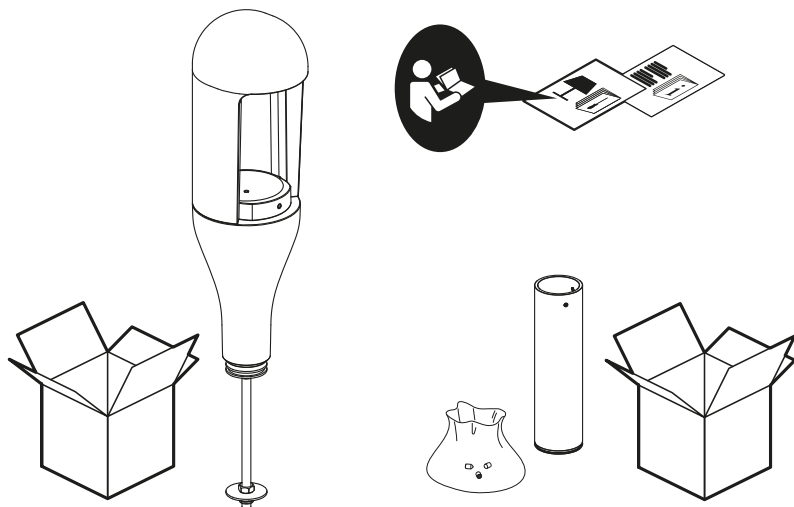
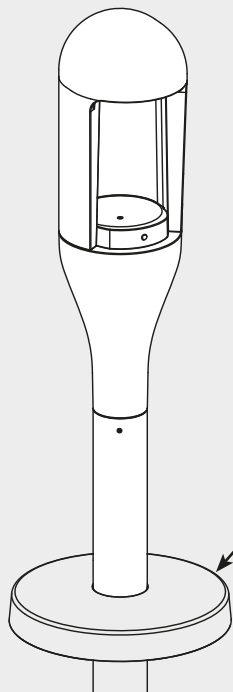

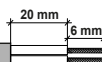
i**Only for T031200 / T031210**H05RN-F
H07RN-FØ 1.5 mm²

Ø 7 - 13.5 mm

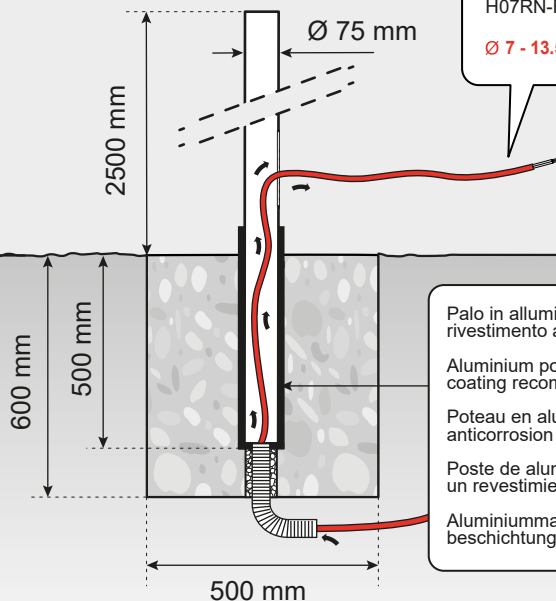

Palo in alluminio: si consiglia rivestimento anti corrosione

Aluminium pole: corrosion-resistant coating recommended

Poteau en aluminium : revêtement anticorrosion recommandé

Poste de aluminio: se recomienda un revestimiento anticorrosivo

Aluminiummast: Korrosionsschutzbeschichtung empfohlen

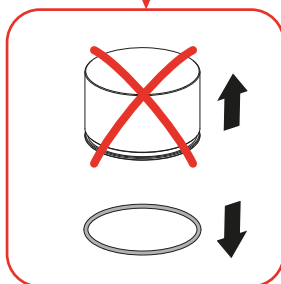
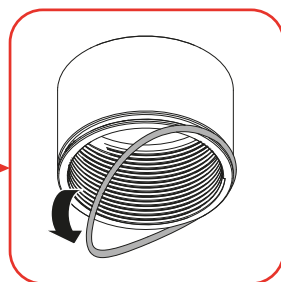
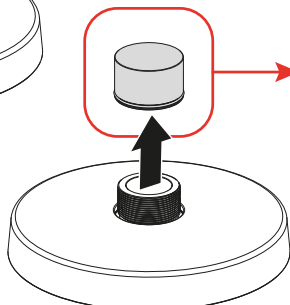
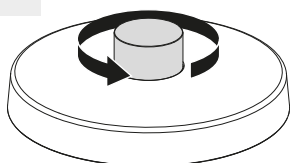
1

2

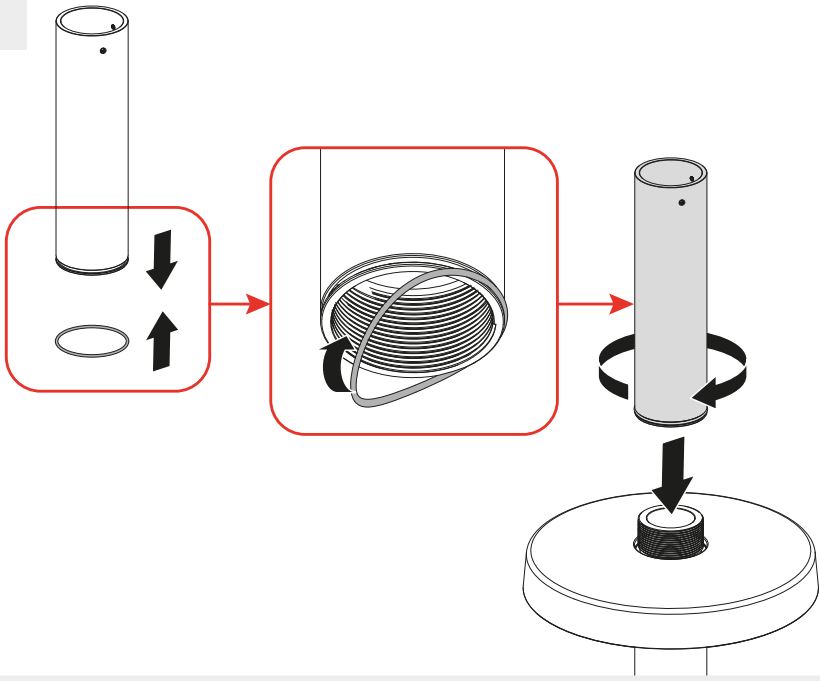

3

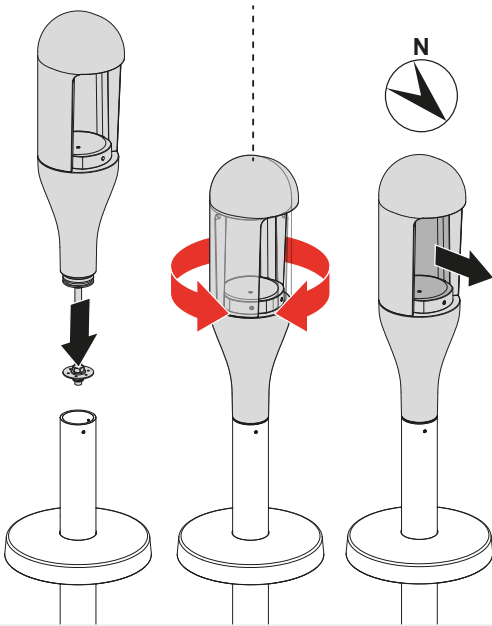

4

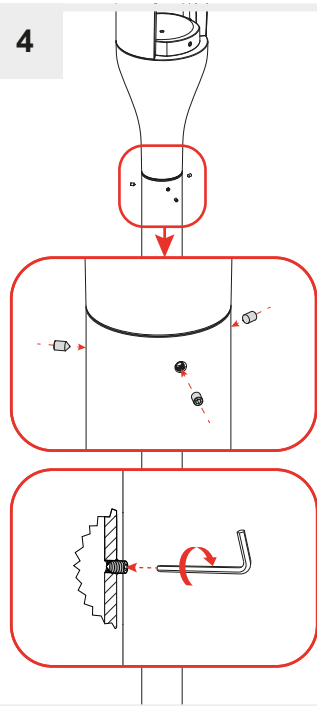

5

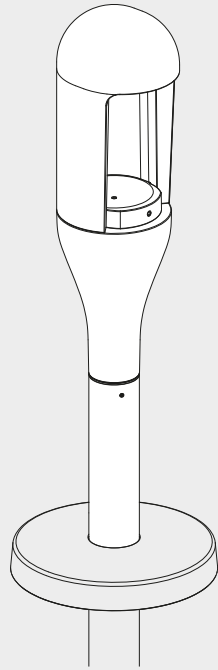
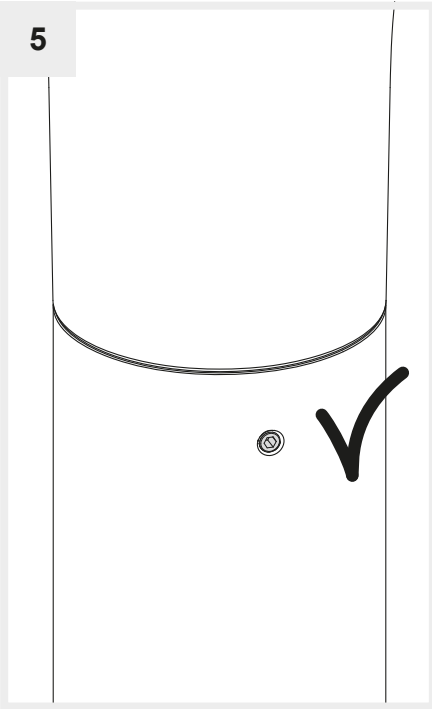

C

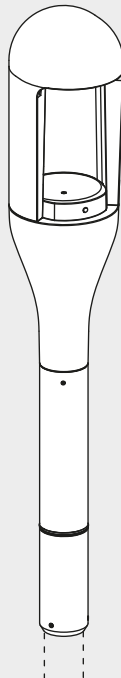

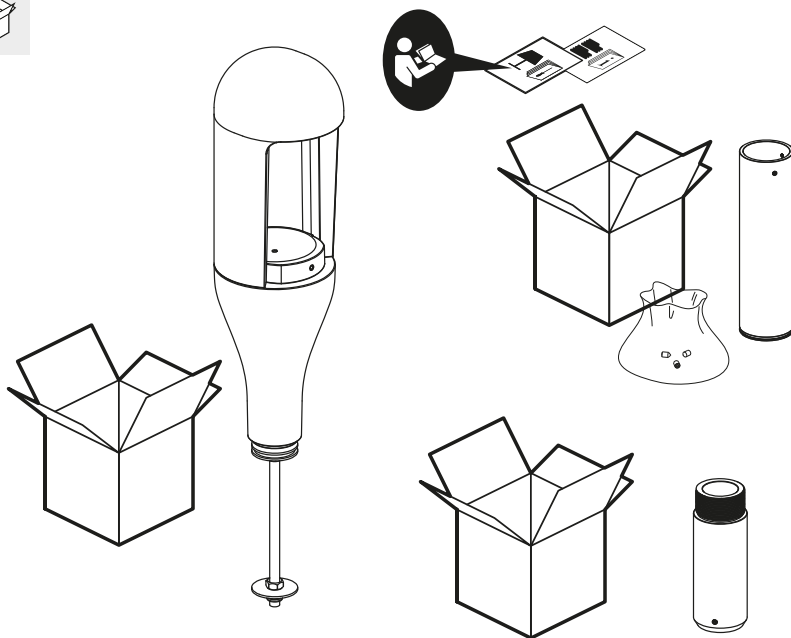

i

Only for commercial pole

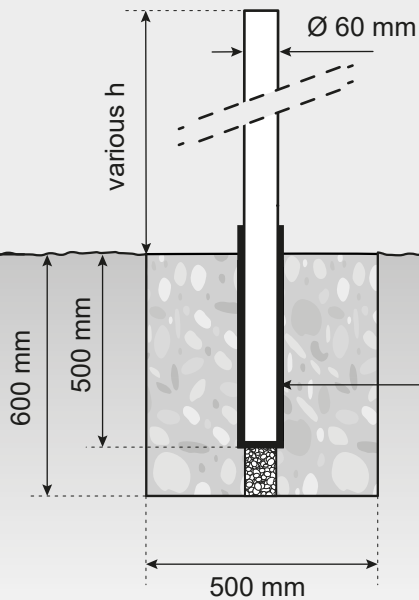

Se palo in alluminio: si consiglia rivestimento anti corrosione

If aluminium pole: corrosion-resistant coating recommended

Si poteau en aluminium: revêtement anticorrosion recommandé

Si es un poste de aluminio: se recomienda un revestimiento anticorrosivo

Wenn Aluminiummast: Korrosionsschutzbeschichtung empfohlen

1

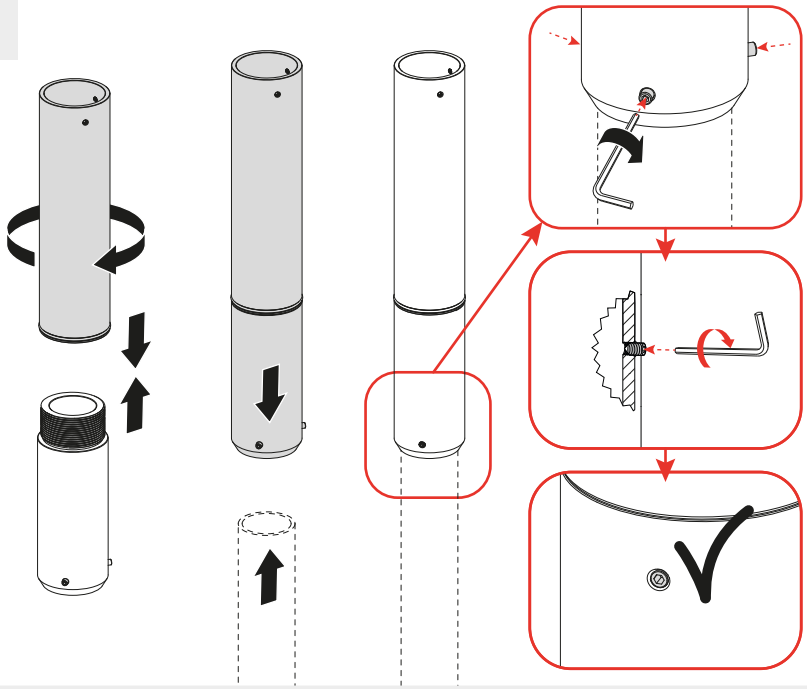

2

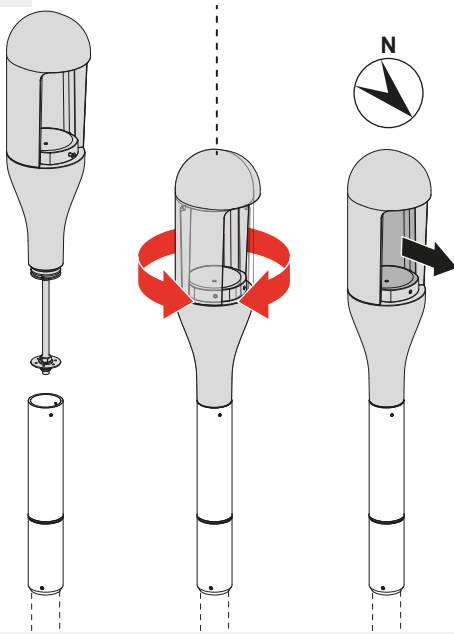

3

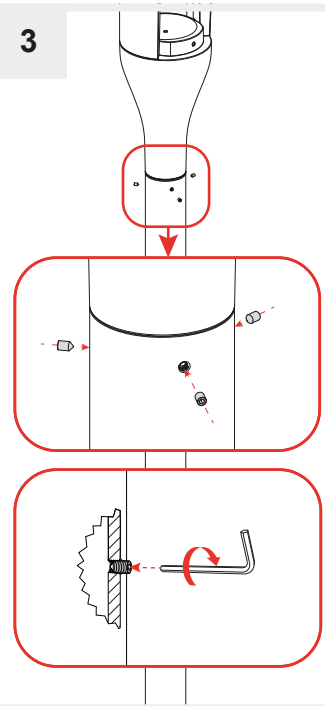

4

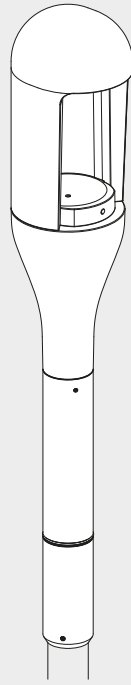
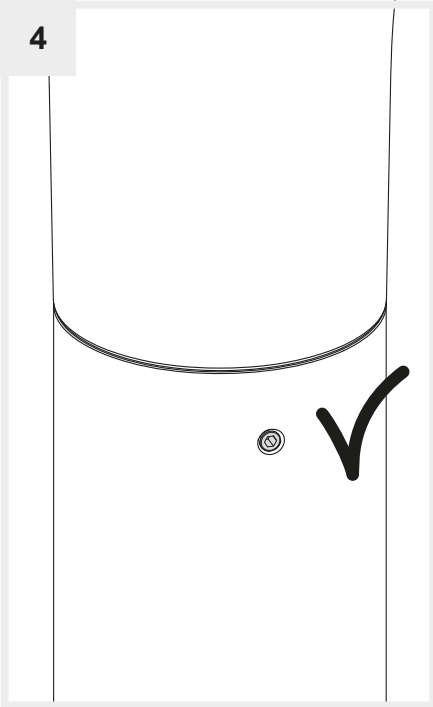

D

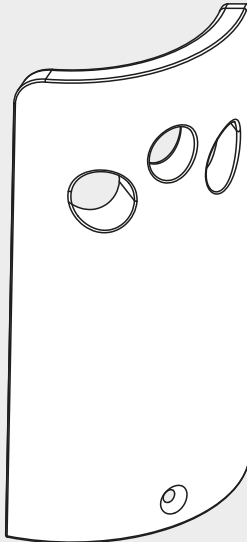

1

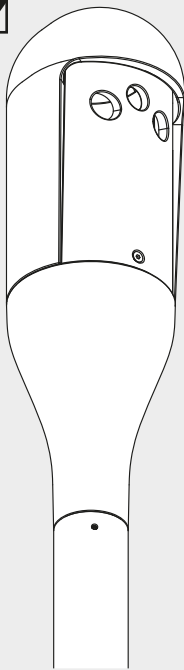
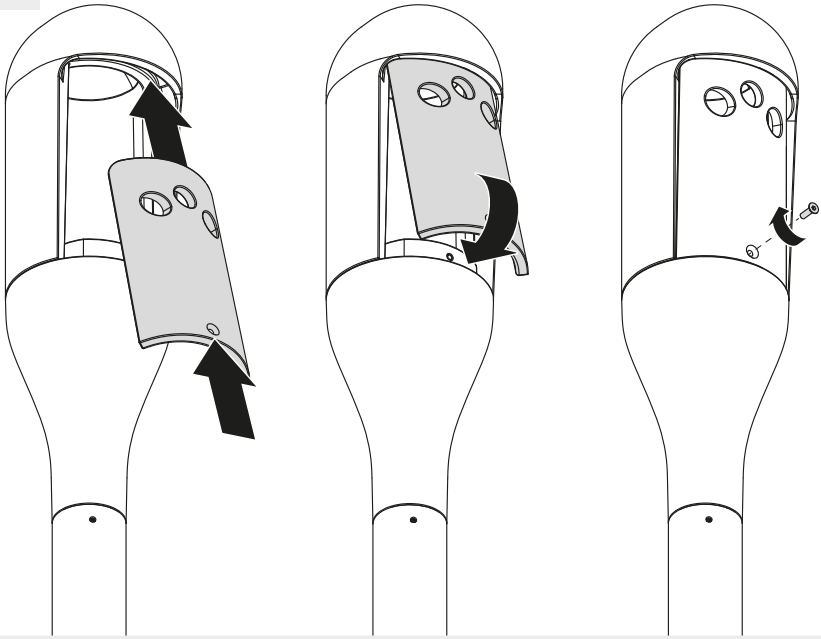

COD.

T031740

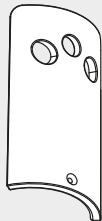

T031730

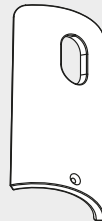

T031700



T031710



T031720

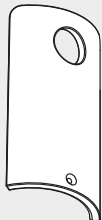

T031750

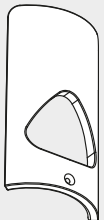

T031760



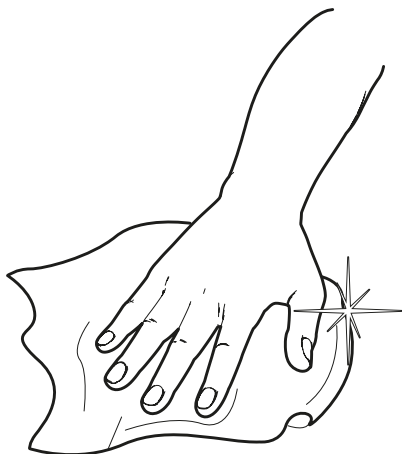

i

- IT** Questo prodotto è ottenuto con procedimenti artigianali. L'eventuale irregolarità di forma o colore costituisce la sua particolarità ed è garanzia di lavorazione manuale.
- EN** This product is obtained by artisanal processes. Any irregularity in shape or colour constitutes its particularity and is a guarantee of manual workmanship.
- FR** Ce produit est obtenu par des procédés artisanaux. Toute irrégularité de forme ou de couleur constitue sa particularité et est une garantie de fabrication manuelle.
- ES** Este producto se obtiene mediante procesos artesanales. Cualquier irregularidad en la forma o el color constituye su particularidad y es una garantía de fabricación manual.
- DEU** Dieses Produkt wird durch handwerkliche Verfahren gewonnen. Jede Unregelmäßigkeit in Form oder Farbe stellt eine Besonderheit dar und ist eine Garantie für handwerkliche Verarbeitung.

Artemide®

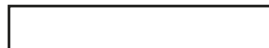

Artemide

via Bergamo, 18
20010 Pregnana M.se (MI)
ITALIA

tel. +39 02 935 181
fax +39 02 935 90 254
fax +39 02 935 90 496

www.artemide.com

VAT IT00846890150

cod. Y513001577