

# Artemide®

## Nesso

design

**G. Mattioli**

Gruppo Architetti Urbanisti Città Nuova

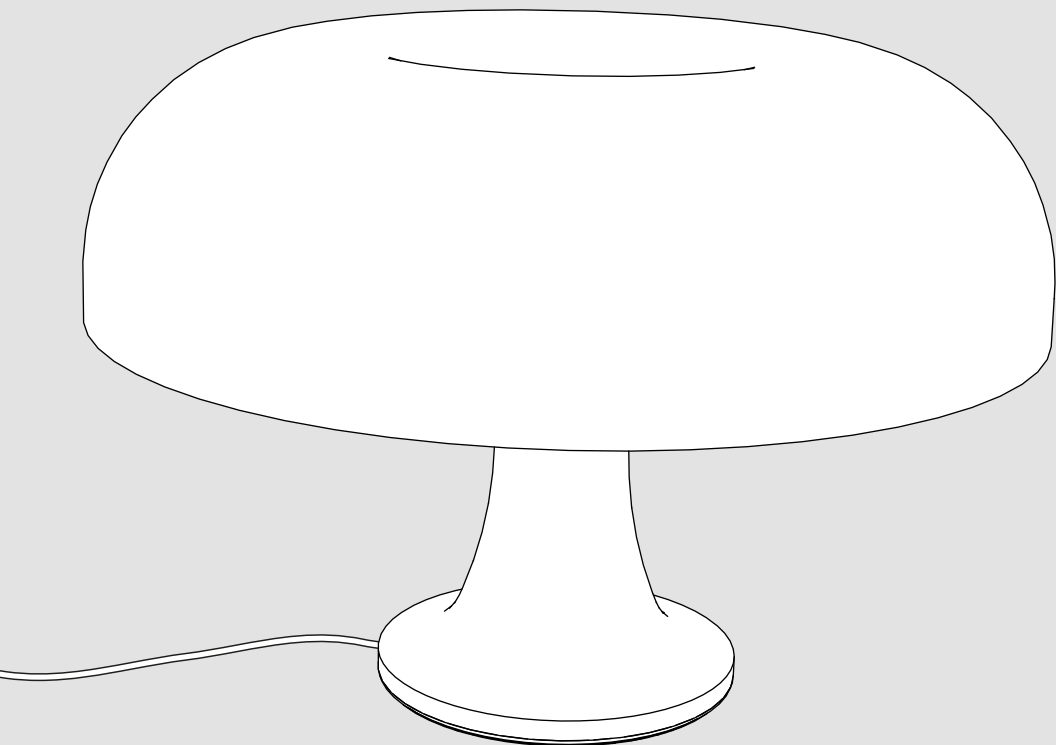



i

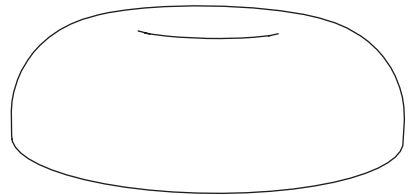
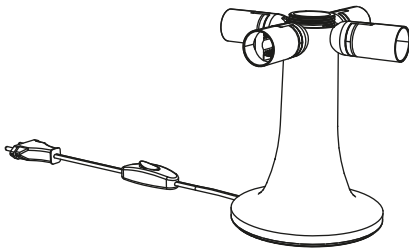
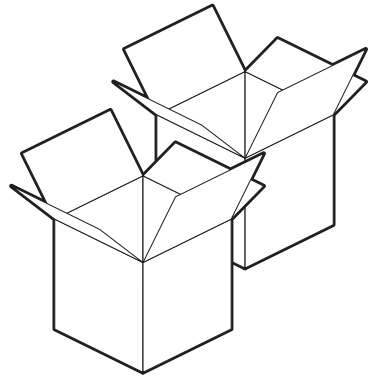
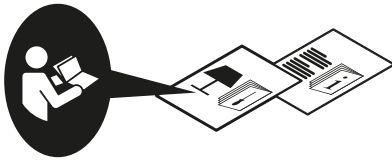
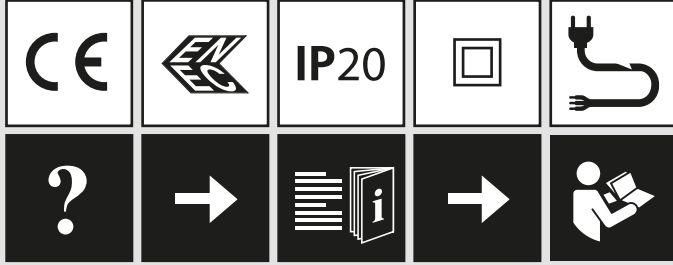

1

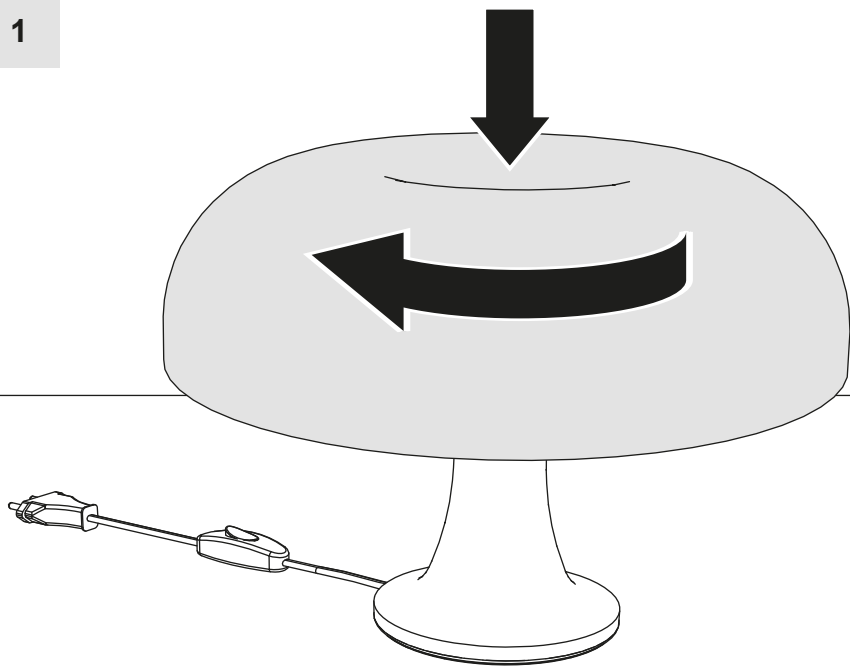

2

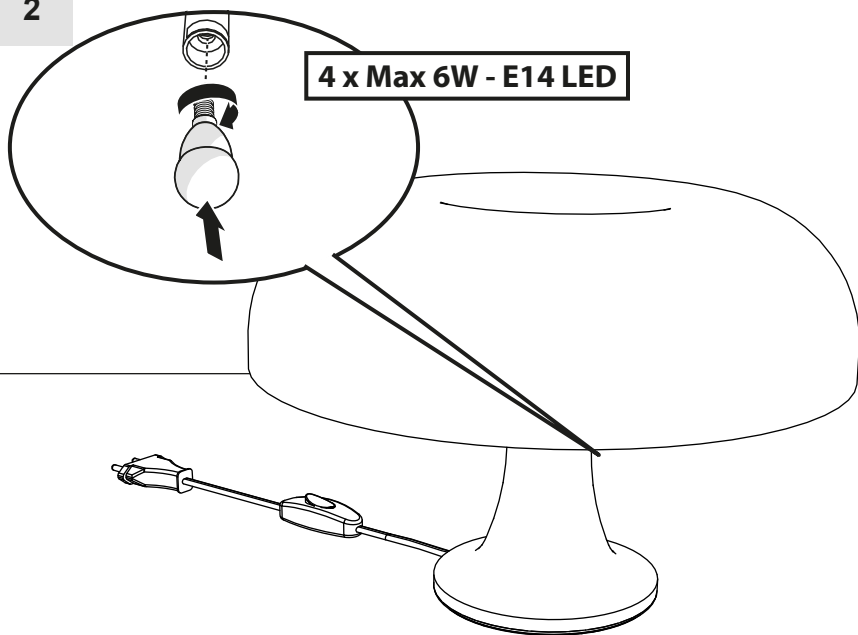

3

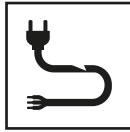
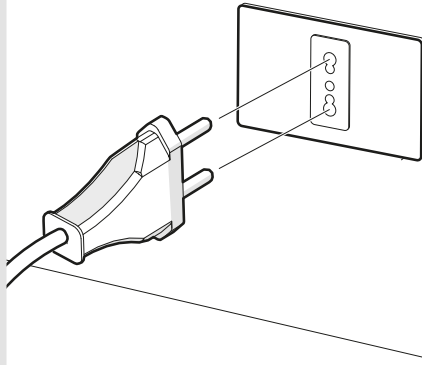

4

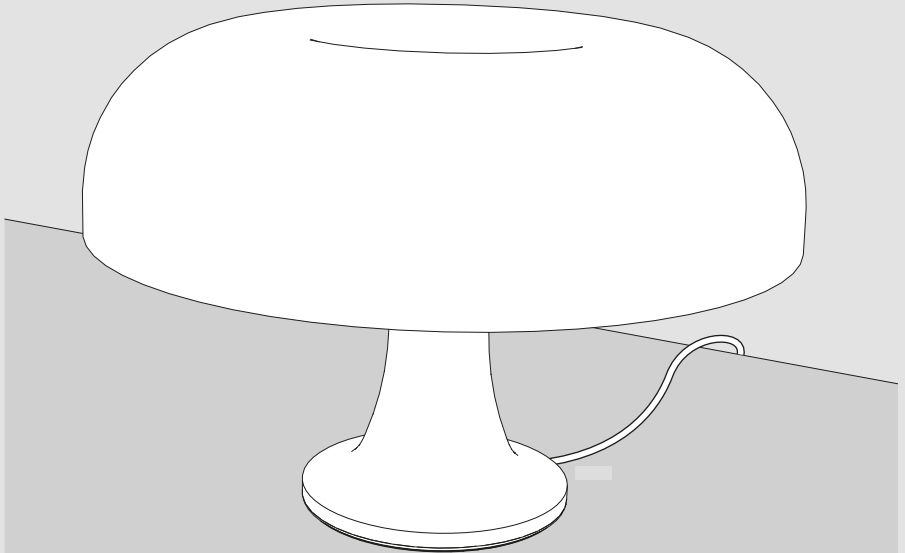
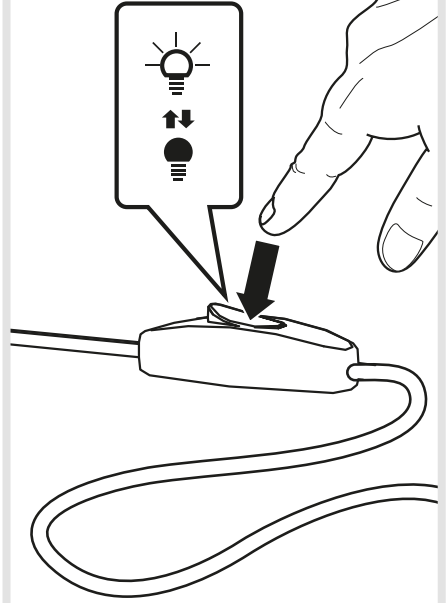

i

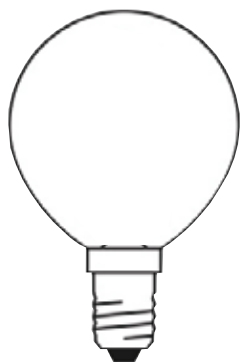

**4 x E14 LED MAX 6W**

**LED: DRBP - 250 lm**

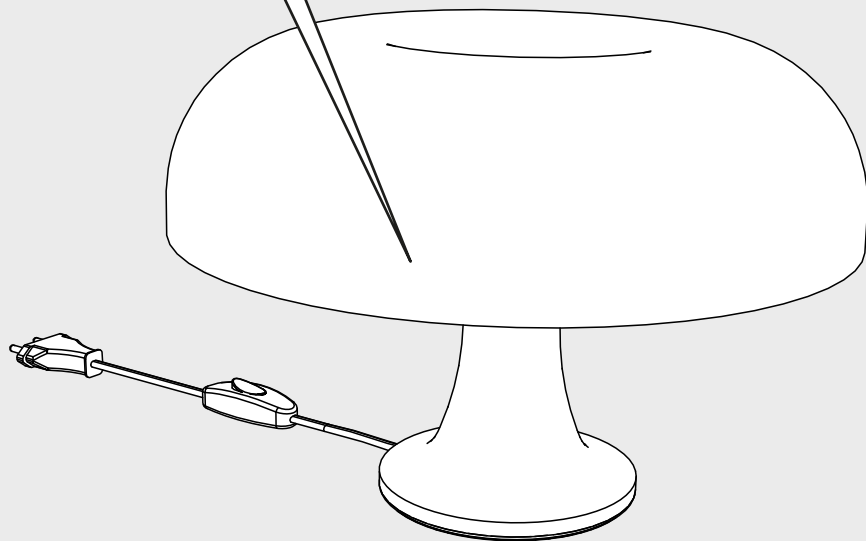

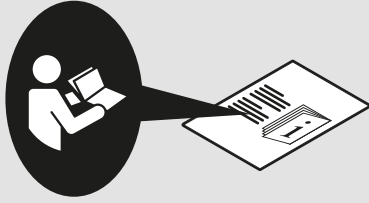



**Artemide®**



**Artemide**

via Bergamo, 18  
20010 Pregnana M.se (MI)  
ITALIA

tel. +39 02 935 181  
fax +39 02 935 90 254  
fax +39 02 935 90 496

[www.artemide.com](http://www.artemide.com)

VAT IT00846890150

cod. Y513000592B