

# Artemide®

## Nur

design  
Ernesto Gismondi

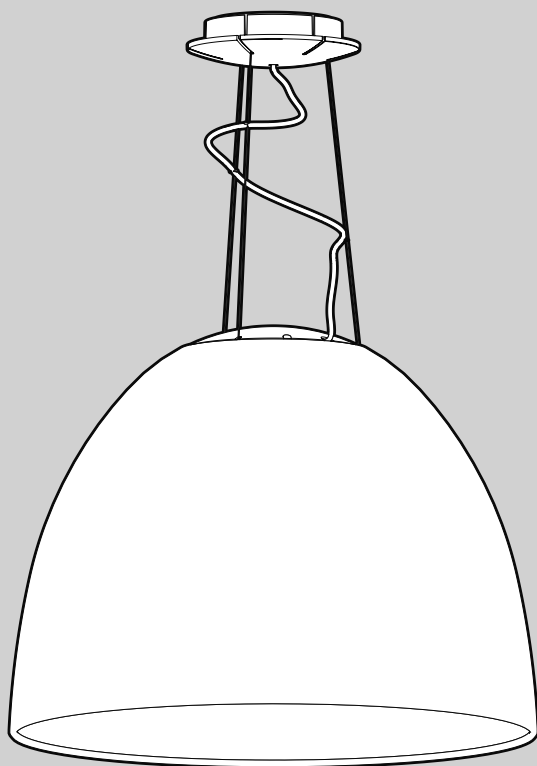



i

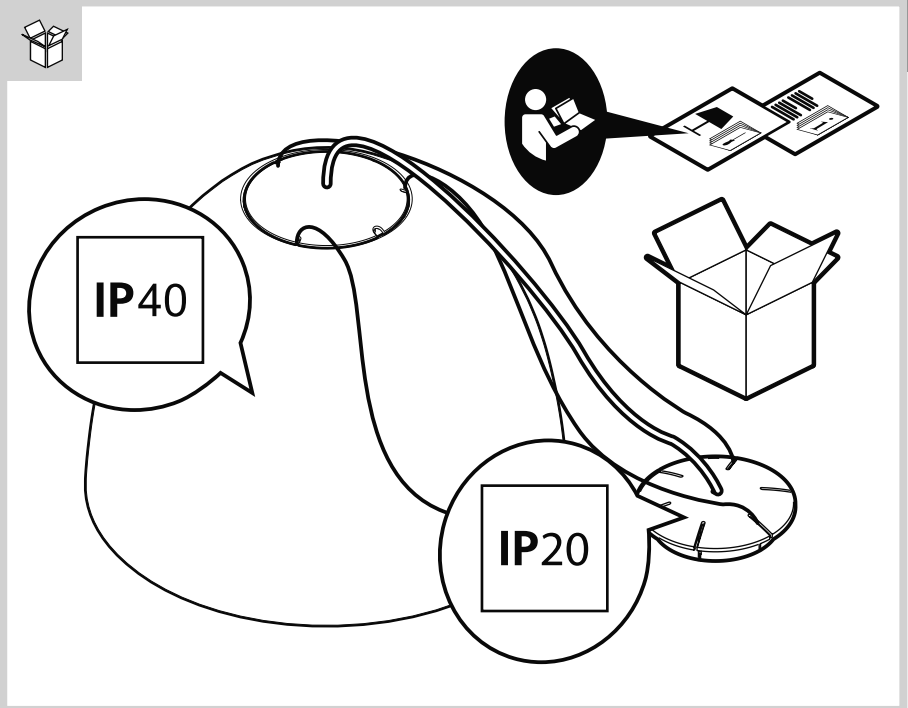
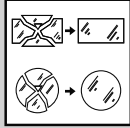

1

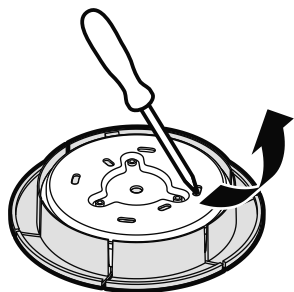

2

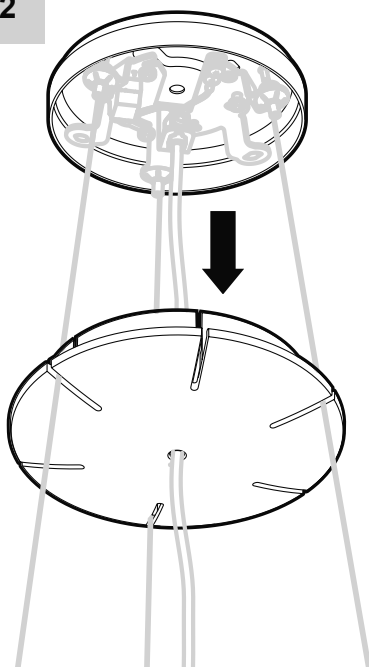

3

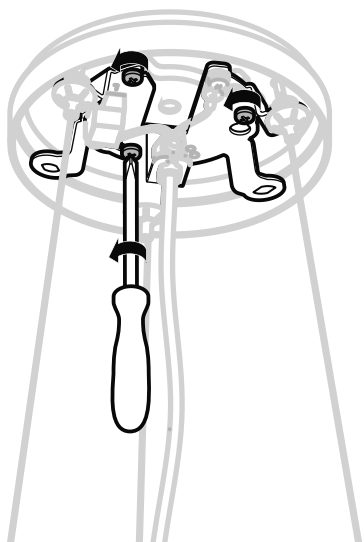

4

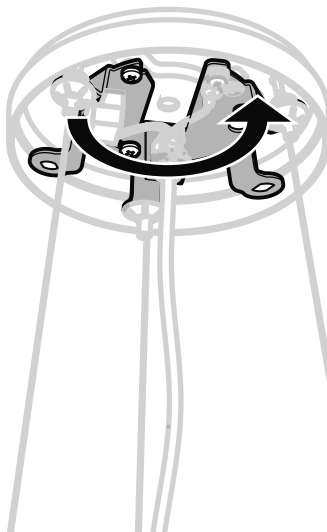

5

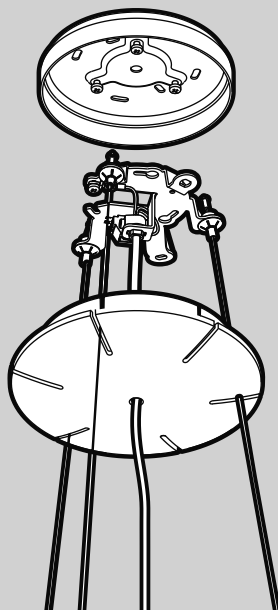
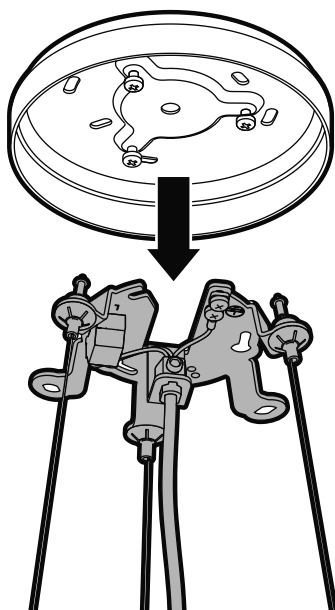

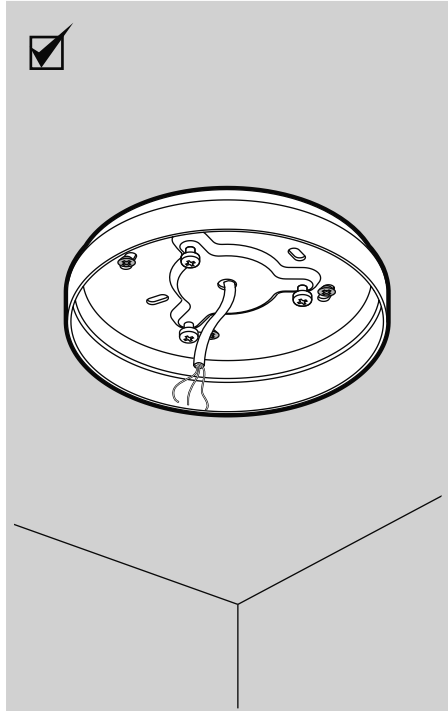
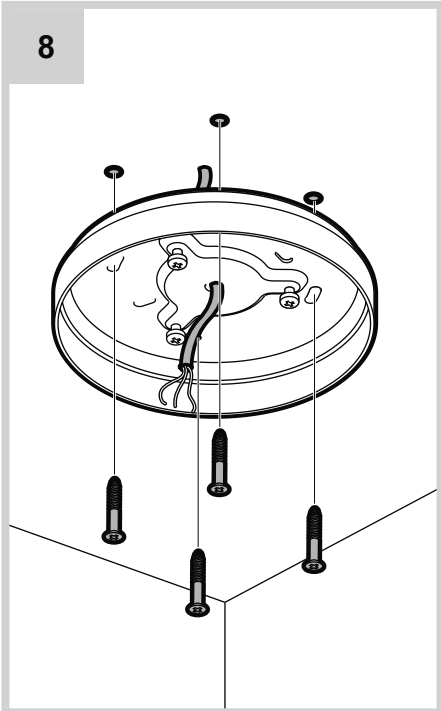
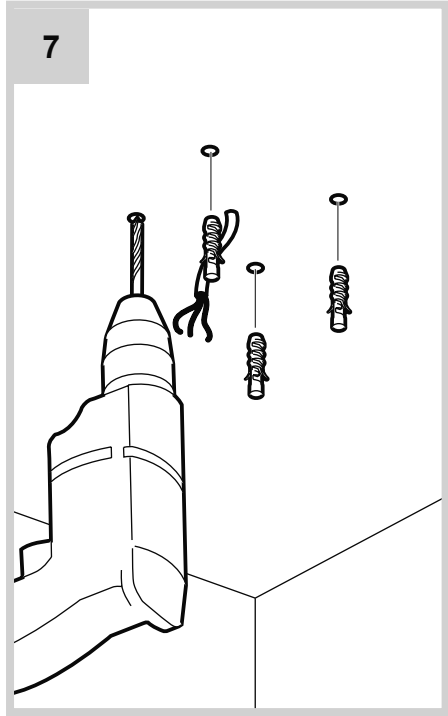
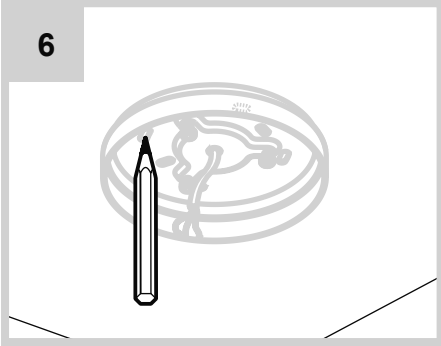
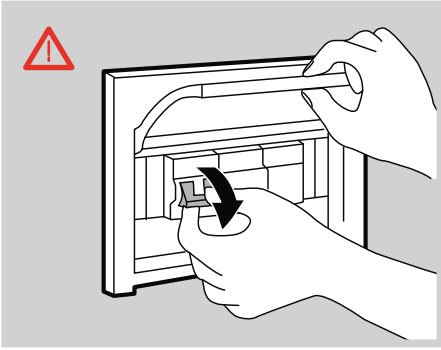

9

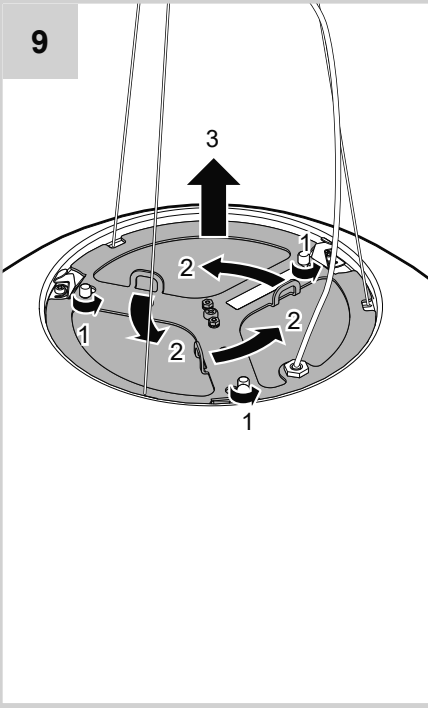

10

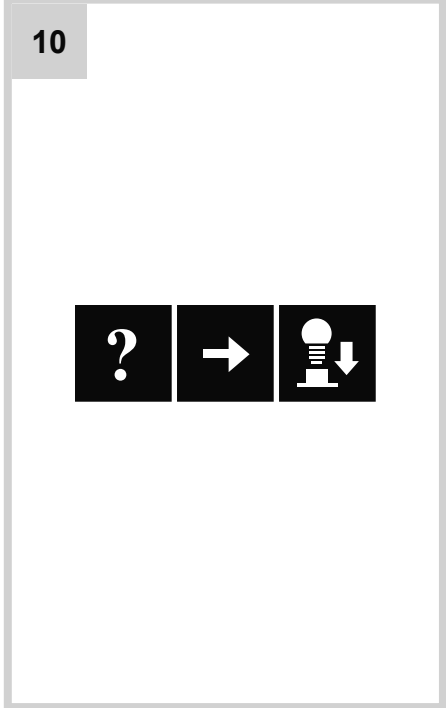

11

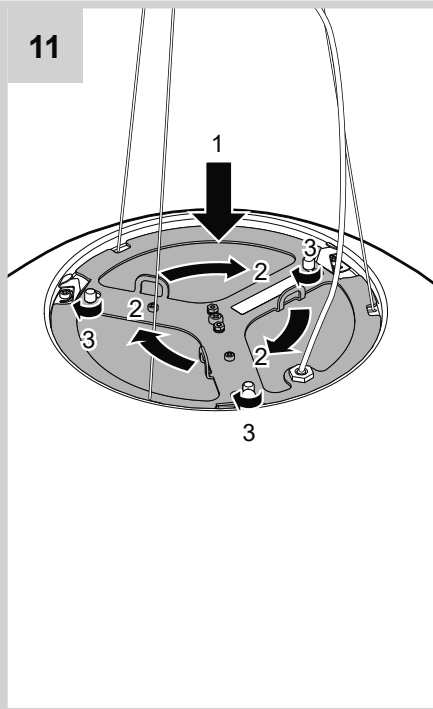

12

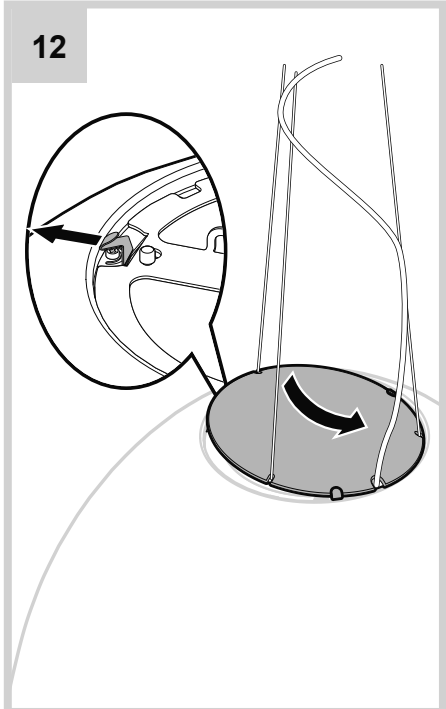

**i**

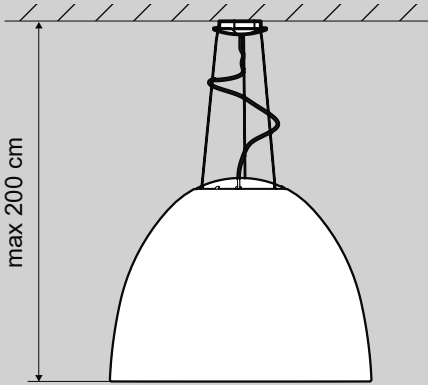

**13**

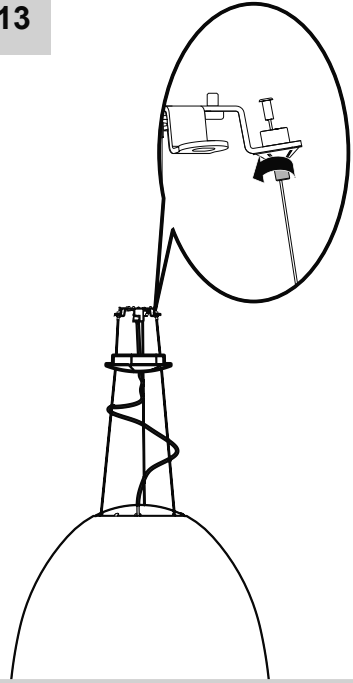

**14**

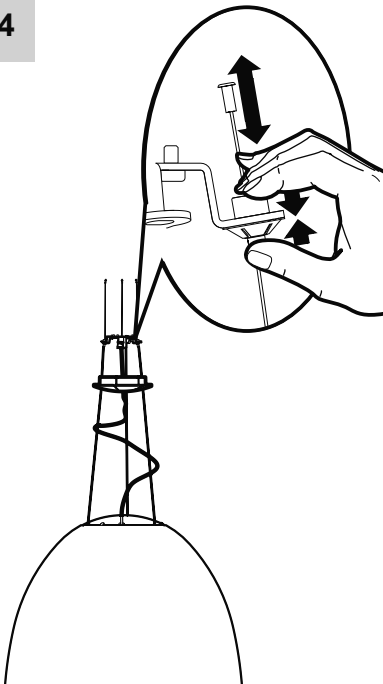

**15**

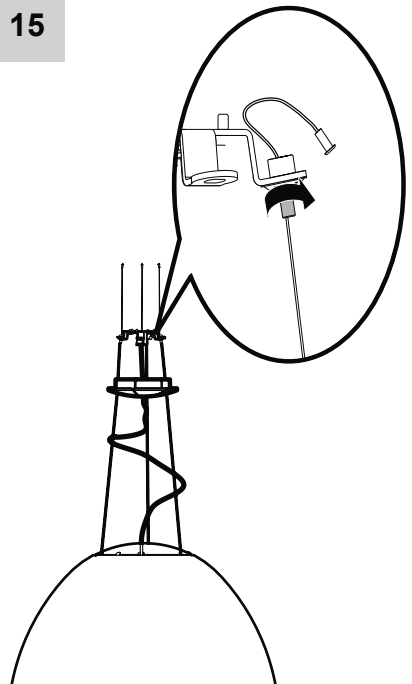

16

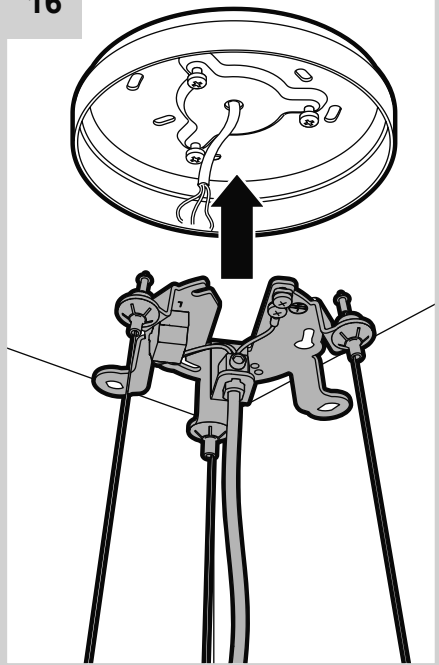

17



18

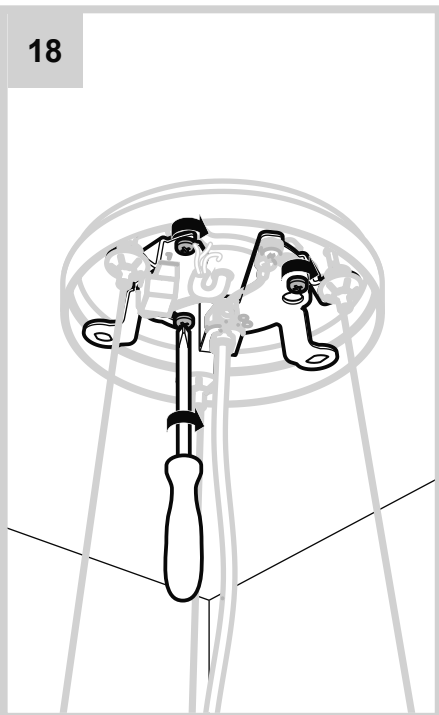

19

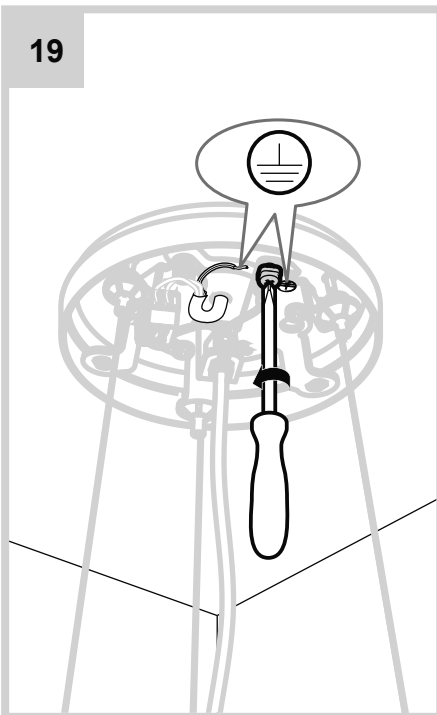



20

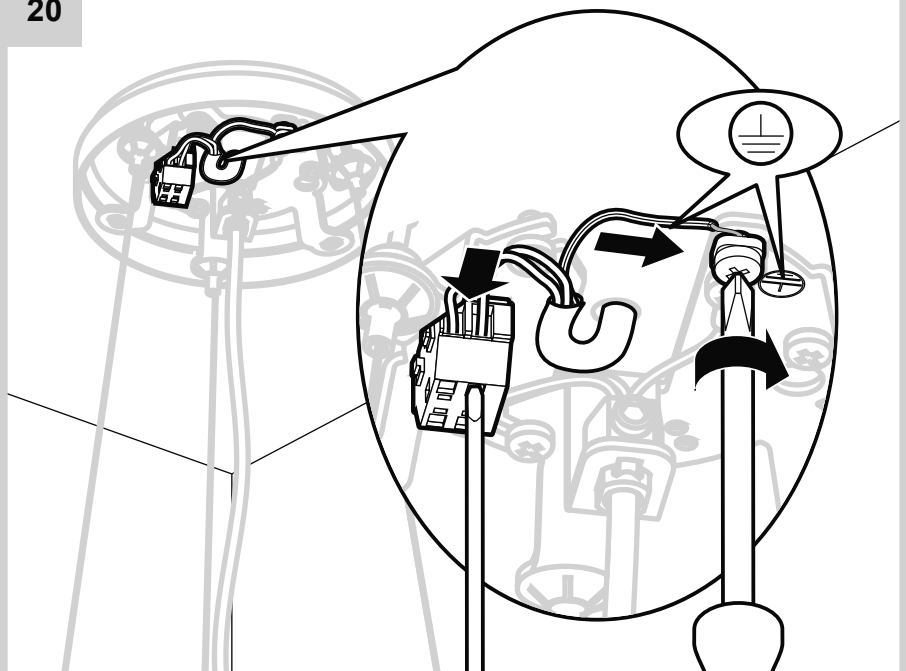

21

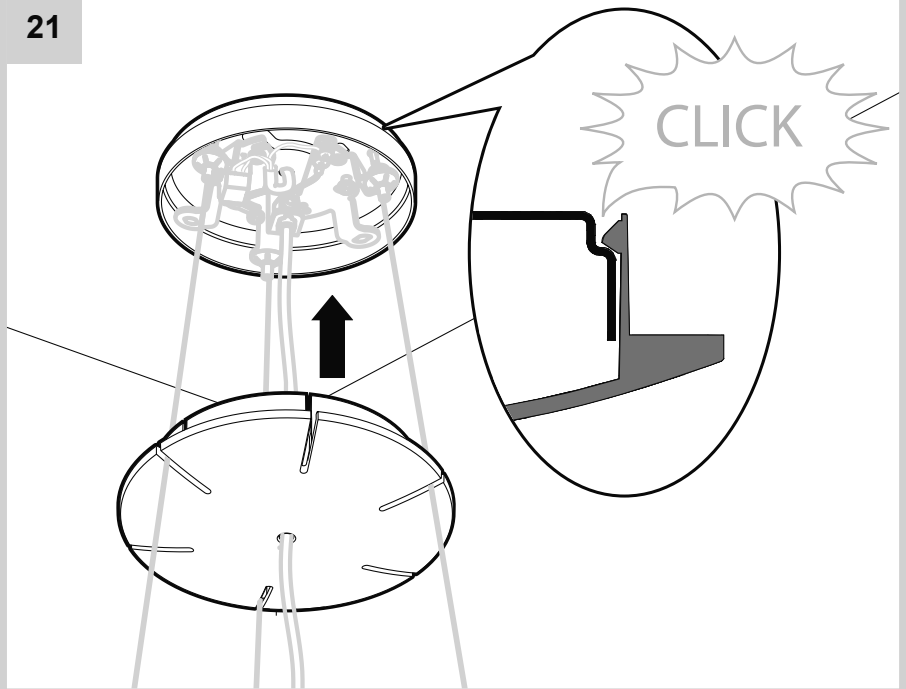

22

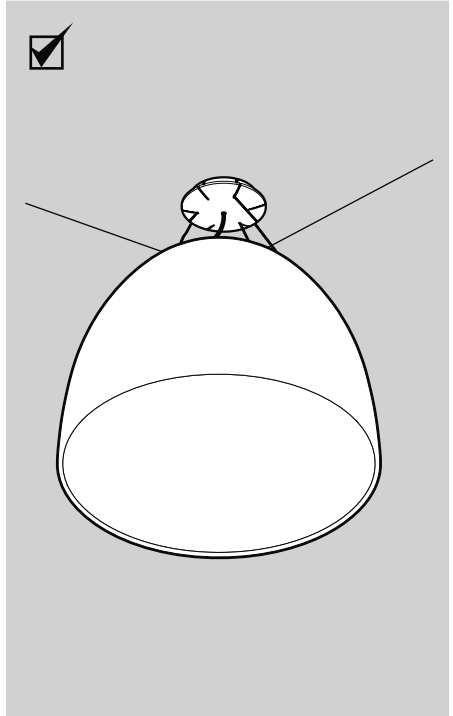
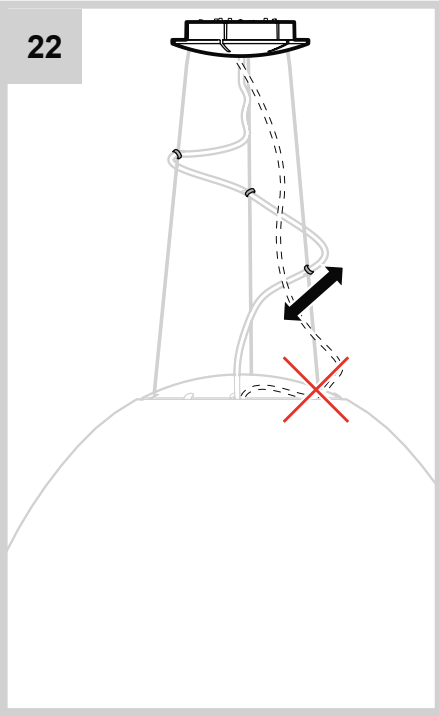



1

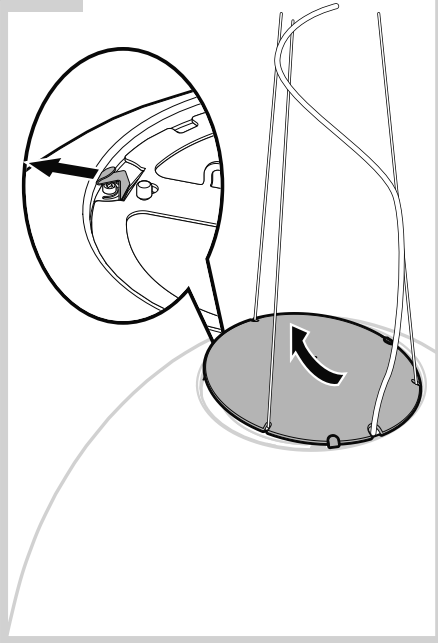

2

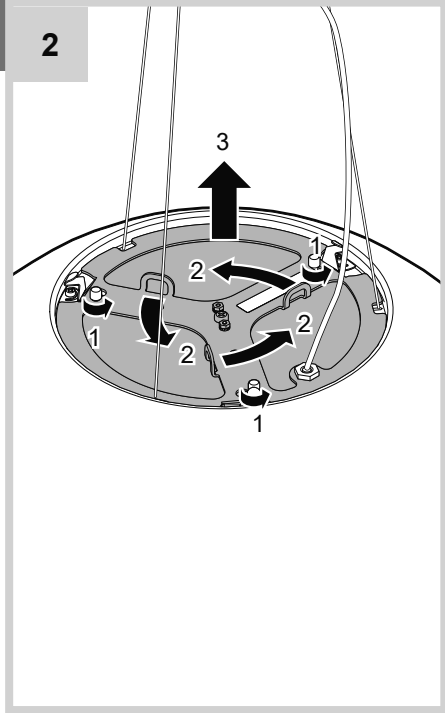

HALO



FLUO



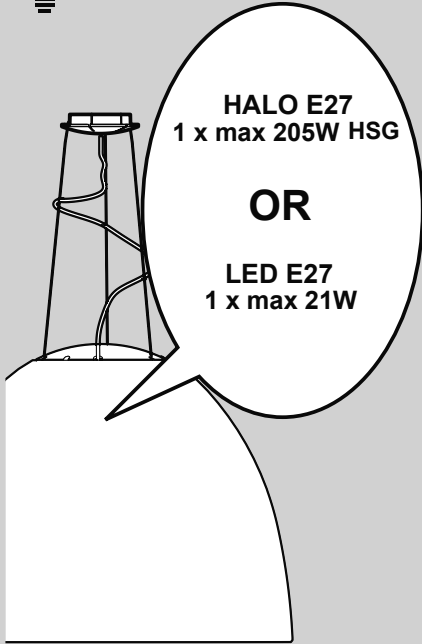

**HALO E27**  
1 x max 205W HSG

**OR**

**LED E27**  
1 x max 21W

**3a**

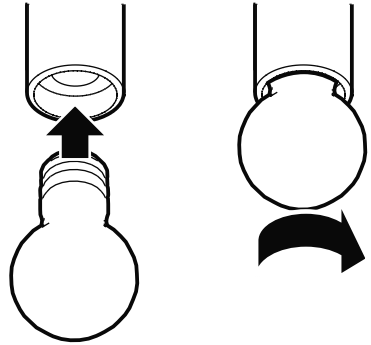

**FLUO**  
1 x 70W  
**FSM**  
GX 24q-6

**3b**

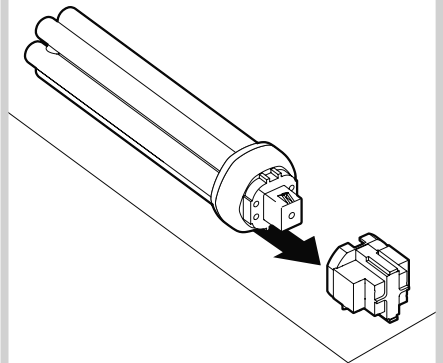

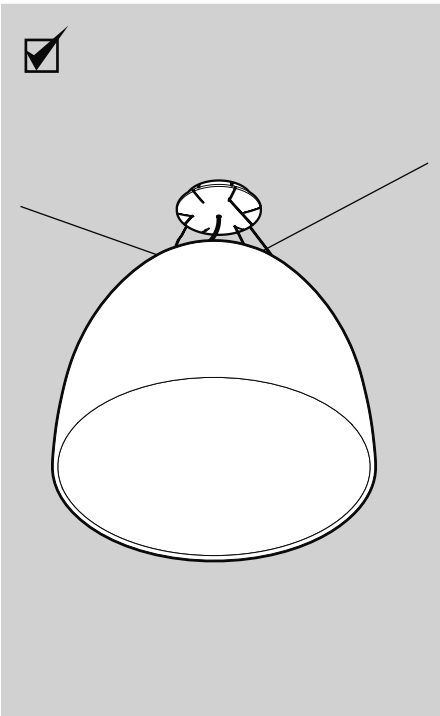
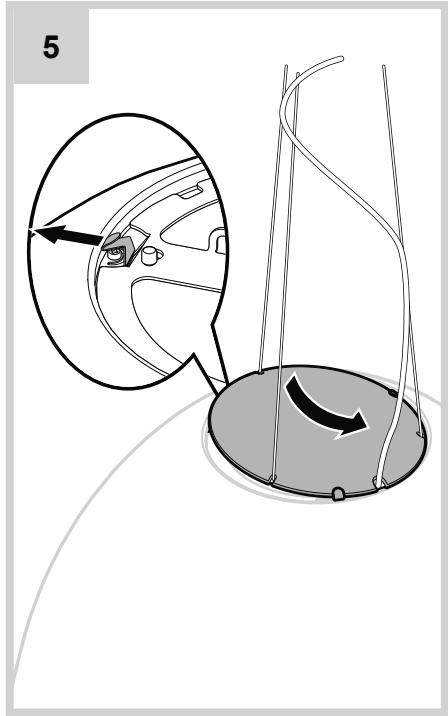
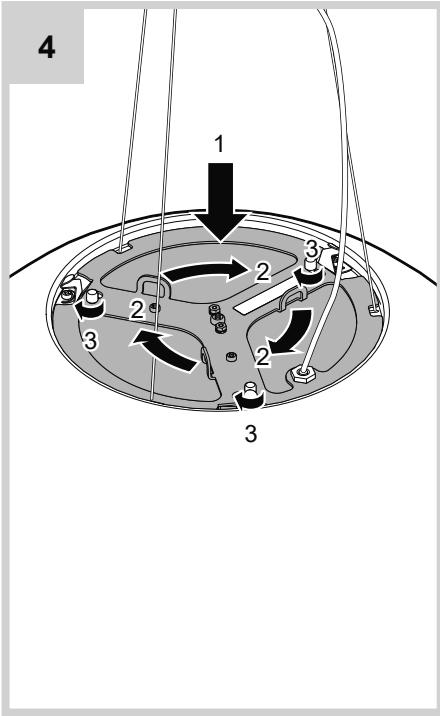



i

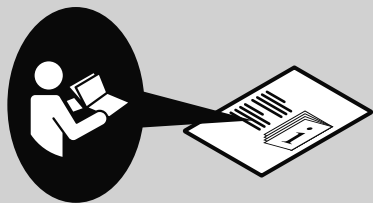

1

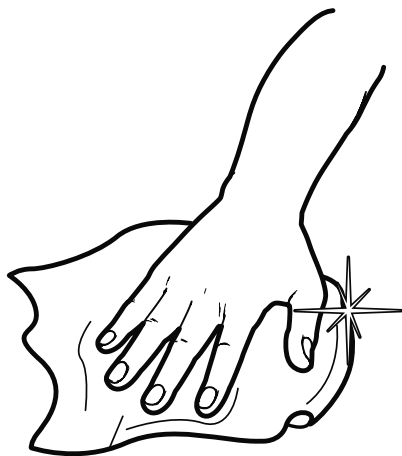



**Artemide®**

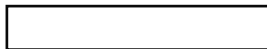

## **Artemide**

via Bergamo, 18  
20010 Pregnana M.se (MI)  
ITALIA

tel. +39 02 935 181  
fax +39 02 935 90 254  
fax +39 02 935 90 496

[www.artemide.com](http://www.artemide.com)

VAT IT00846890150

cod. Y513000021A