

## Reeds

design  
Klaus Begasse

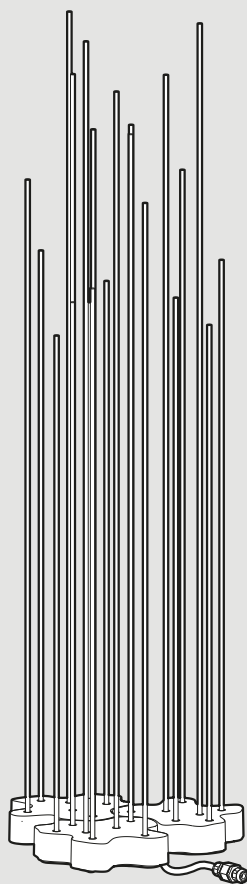

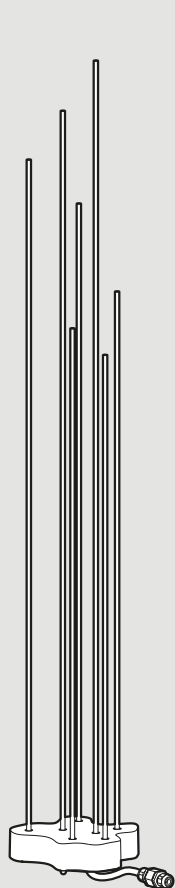

i

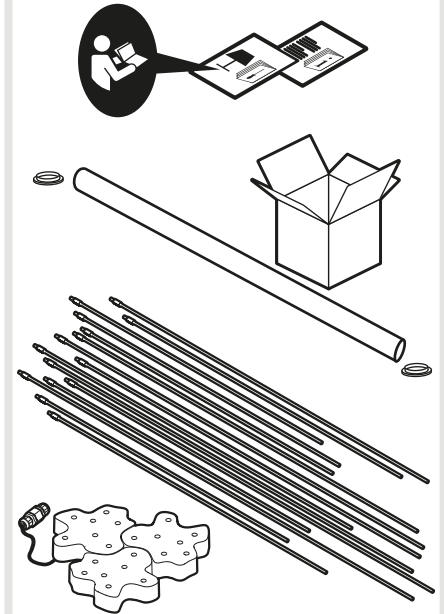
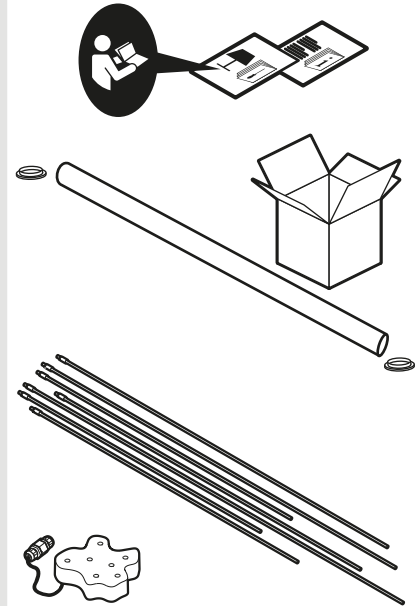
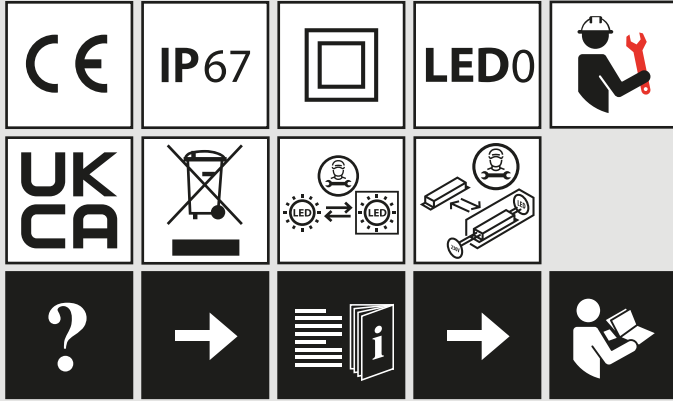

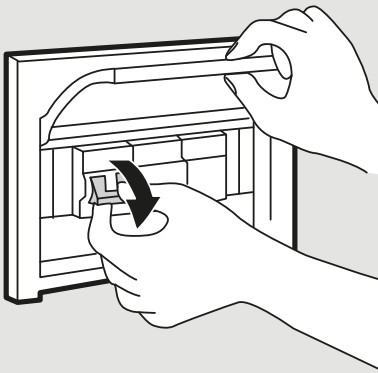

1

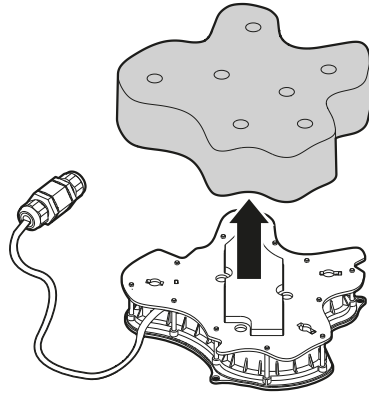

2

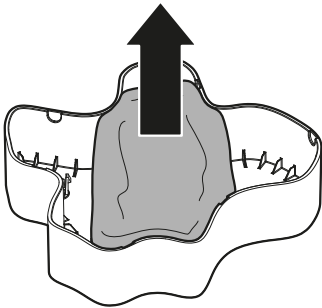

3

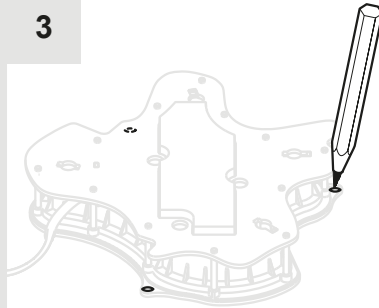

4

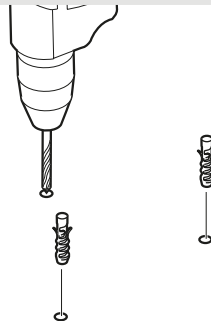

5a

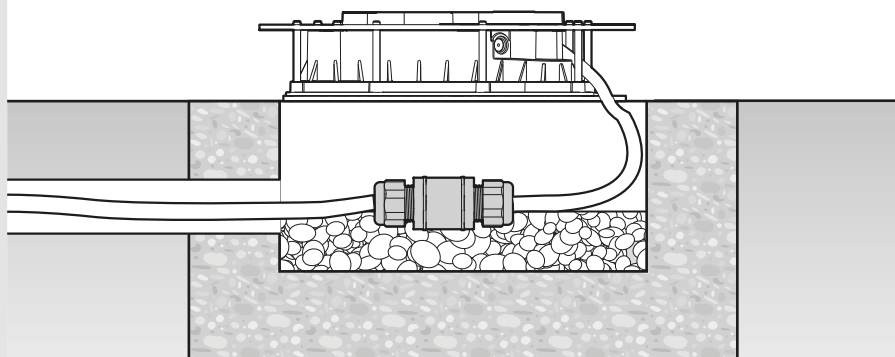

5b

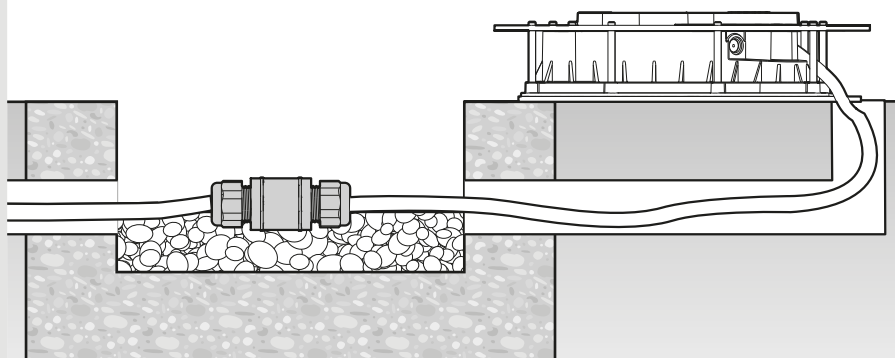

6

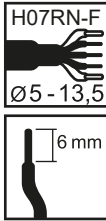
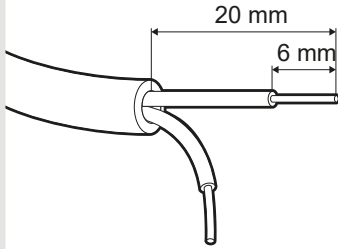

7

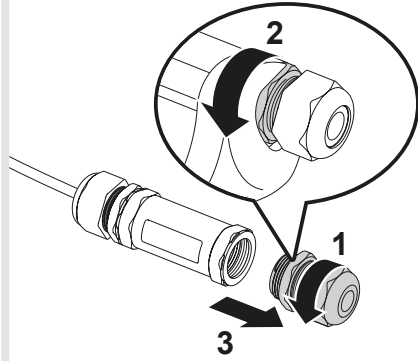

8

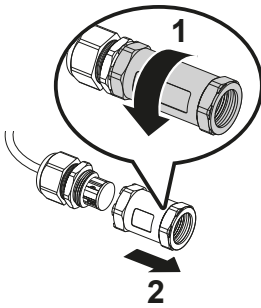

9

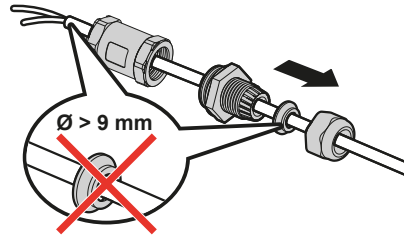

10

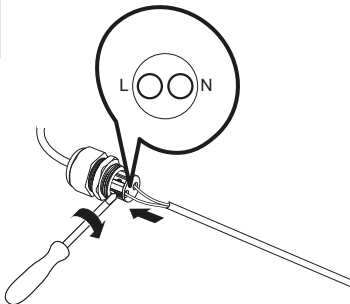

11

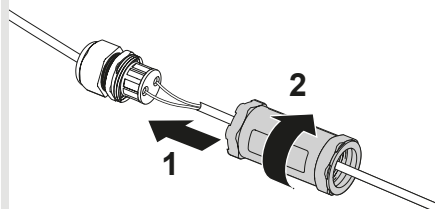

12

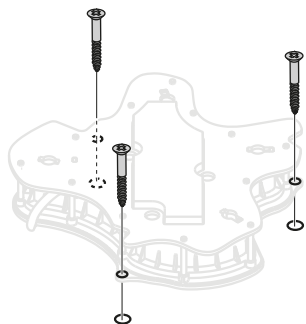

13

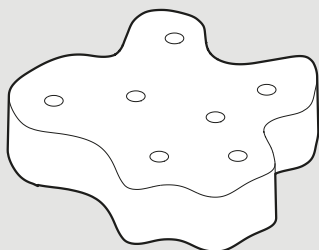
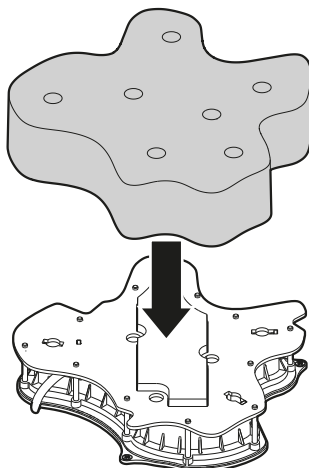

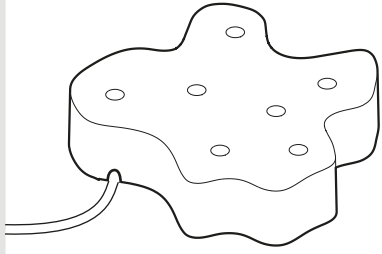

**i**



**i**

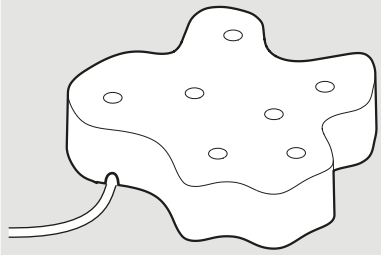
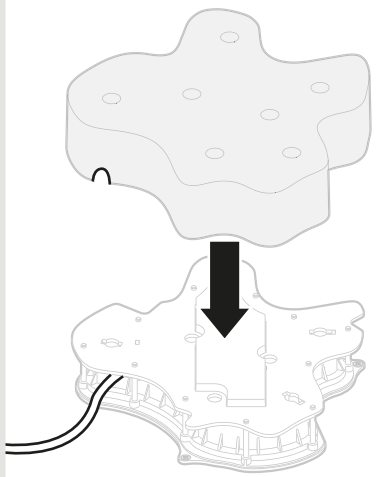

14

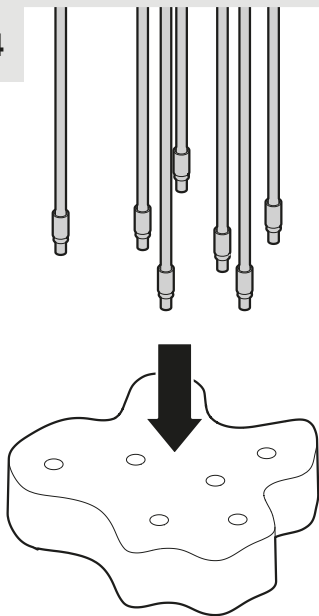

15

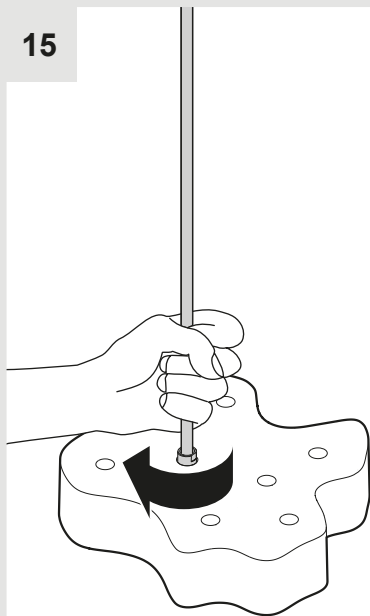

16

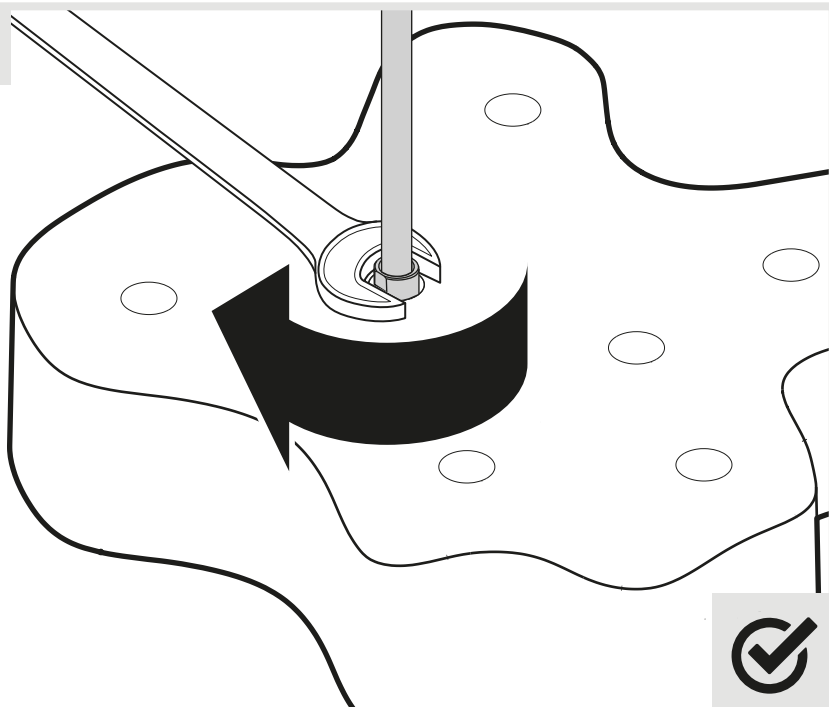



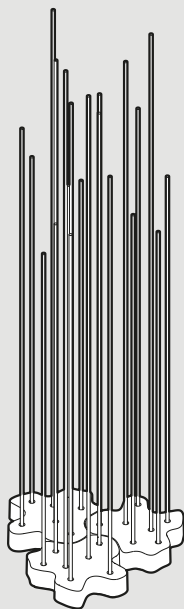
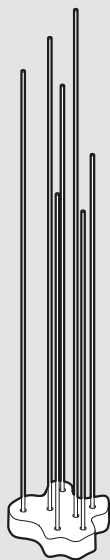

**i**

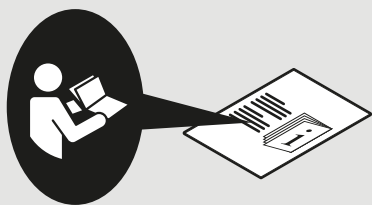

**1**

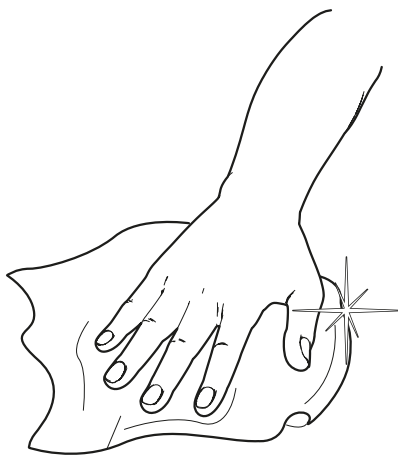





**Artemide®**



## **Artemide**

via Bergamo, 18  
20006 Pregnana M.se (MI)  
ITALIA

tel. +39 02 935 181  
fax +39 02 935 90 254  
fax +39 02 935 90 496

[www.artemide.com](http://www.artemide.com)

VAT IT00846890150

cod. Y513000103E