

A.24 - Ceiling Magnetic Track - Curved Joining Elements (not magnetic) - 750mm - 90° - Brushed Copper

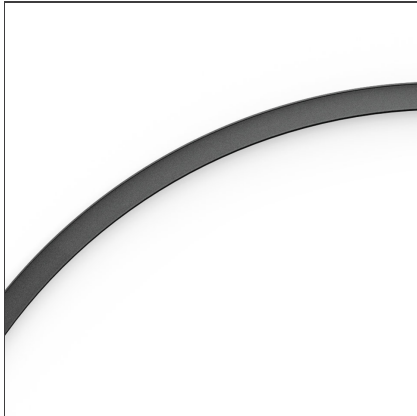

IP20   

DESIGN BY

Carlotta de Bevilacqua

DESCRIPTION

A.24 is a new comprehensive and flexible system to design light in space. A single profile, only 24 mm thick, can be installed in the recessed, ceiling or suspension mode to continuously follow the angles on a flat or three-dimensional surface. This profile hosts to a variety of performance options: diffused light, sharp optical units with three beam angles, or a smart magnetic track. This makes A.24 a flexible system, as well as an open platform to accommodate other products from the Architectural collection. The suspension version also features direct emission. The three solutions can be alternated to match the architecture and the room functions with utmost flexibility. The competence of Artemide is revealed by the quality of light, as well as by the ability of A.24 to freely move in space, with direct power connection points up to 14 metres apart.

TECHNICAL DRAWINGS

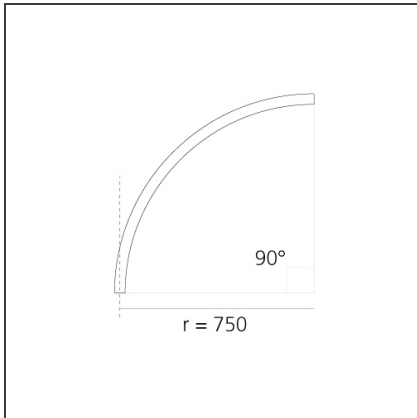

FEATURES

Article Code:	AQ63018	Series:	Indoor
Colour:	Brushed Copper		
Installation:	Ceiling, Suspension, Recessed		
Environment:	Indoor		

DIMENSIONS

Notes

Each linear, angle and curved elements are provided with mechanical and electrical joints and installation accessories. End caps have to be ordered separately. Bracket for fixing to ceiling is included: 1 for 1176mm length or 2 for 2352mm length. Depending on the driver, the product can be undimmable or dimmable DALI.

ACCESSORIES



150W Ceiling power supply kit (cable length 2,2 m) - 230VAC-48VDC - IP20 - 321x91x111H - White - Undimmable AQ17901

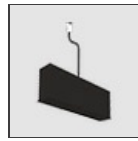

150W Ceiling power supply kit (cable length 2,2 m) - 230VAC-48VDC - IP20 - 321x91x111H - Black - Undimmable AQ17904

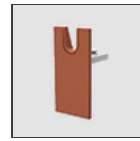

A.24 - Ceiling - Cap for cable passage. (1 pcs) - Brushed Copper AQ39518

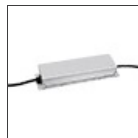

240W Bare power supply + plug 230VAC-48VDC IP20 - Undimmable (for dimmable version to be combined with "DALI-Selv interface") AQ18000



150W Bare power supply + plug 230VAC-48VDC IP20 - Undimmable (for dimmable version to be combined with "DALI-Selv interface") AQ18100

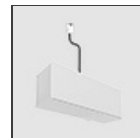

240W Ceiling power supply kit (cable length 2,2 m) - 230VAC-48VDC - IP20 - 321x91x111H - White - DALI AQ17201

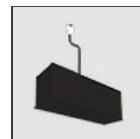

240W Ceiling power supply kit (cable length 2,2 m) - 230VAC-48VDC - IP20 - 321x91x111H - Black - DALI AQ17204

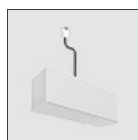

240W Ceiling power supply kit (cable length 2,2 m) - 230VAC-48VDC - IP20 - 321x91x111H - White - APP Compatible AQ17201APP

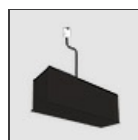

240W Ceiling power supply kit (cable length 2,2 m) - 230VAC-48VDC - IP20 - 321x91x111H - Black - APP Compatible AQ17204APP



240W Remote box power supply kit (2 connectors) - 230VAC-48VDC - IP20 - 313x243x57,5H - DALI AQ16000

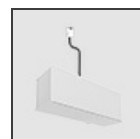

150W Ceiling power supply kit (cable length 2,2 m) - 230VAC-48VDC - IP20 - 321x91x111H - White - APP Compatible AQ17701APP

240W Remote box



power supply kit
(cable length 2,2
m) - 230VAC-
48VDC - IP20 -
396x195x112H -
DALI
AQ16801

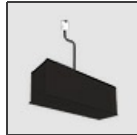

power supply kit
(cable length 2,2
m) - 230VAC-
48VDC - IP20 -
321x91x111H -
Black - APP
Compatible
AQ17704APP



power supply kit
(2 connectors) -
230VAC-48VDC -
IP20 -
313x243x57,5H -
APP Compatible
AQ16000APP



240W Recessed
power supply kit
(cable length 2,2
m) - 230VAC-
48VDC - IP20 -
396x195x112H -
Undimmable
AQ17801



240W Ceiling
power supply kit
(cable length 2,2
m) - 230VAC-
48VDC - IP20 -
321x91x111H -
White -
Undimmable
AQ17301

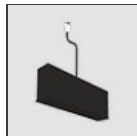

240W Ceiling
power supply kit
(cable length 2,2
m) - 230VAC-
48VDC - IP20 -
321x91x111H -
Black -
Undimmable
AQ17304

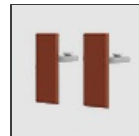

A.24 - Ceiling - End
caps. (2pcs) -
Brushed Copper
AQ39018



A.24 - Ceiling -
Transition joint -
Use between
different typology
modules (track-
diffusing-
sharping) -
Brushed Copper
AQ39418



240W Recessed
power supply kit
(cable length 2,2
m) - 230VAC-
48VDC - IP20 -
396x195x112H -
APP Compatible
AQ16801APP

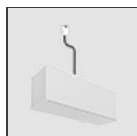

150W Ceiling
power supply kit
(cable length 2,2
m) - 230VAC-
48VDC - IP20 -
321x91x111H -
White - DALI
AQ17701

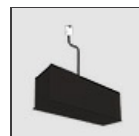

150W Ceiling
power supply kit
(cable length 2,2
m) - 230VAC-
48VDC - IP20 -
321x91x111H -
Black - DALI
AQ17704

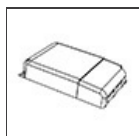

DALI to DALI-Selv
Interface
103x67x21H
AQ18200



A.24 - Ceiling -
Insulating Spacer -
Use between
modules powered
by different power
supplies (1pcs) -

Brushed Copper
AQ39118