

A.24 - Suspension Magnetic Track - Curved Joining Elements (not magnetic) - 750mm - 90° - Brushed Copper



IP20   

DESIGN BY

Carlotta de Bevilacqua

DESCRIPTION

A.24 is a new comprehensive and flexible system to design light in space. A single profile, only 24 mm thick, can be installed in the recessed, ceiling or suspension mode to continuously follow the angles on a flat or three-dimensional surface. This profile hosts to a variety of performance options: diffused light, sharp optical units with three beam angles, or a smart magnetic track. This makes A.24 a flexible system, as well as an open platform to accommodate other products from the Architectural collection. The suspension version also features direct emission. The three solutions can be alternated to match the architecture and the room functions with utmost flexibility. The competence of Artemide is revealed by the quality of light, as well as by the ability of A.24 to freely move in space, with direct power connection points up to 14 metres apart.

TECHNICAL DRAWINGS

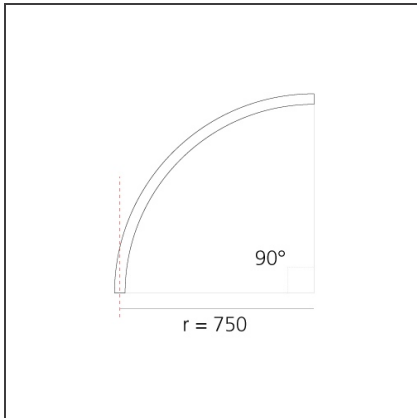

FEATURES

Article Code:	AQ73018	Series:	Indoor
Colour:	Brushed Copper		
Installation:	Ceiling, Suspension, Recessed		
Environment:	Indoor		

DIMENSIONS

Notes

Each linear, angle and curved elements are provided with mechanical and electrical joints and installation accessories. End caps have to be ordered separately. 1 suspension cable is also included. Depending on the driver, the product can be undimmable or dimmable DALI.

ACCESSORIES



240W Ceiling power supply kit (cable length 2,2 m) - 230VAC-48VDC - IP20 - 321x91x111H - Black - APP Compatible AQ16104APP



150W Ceiling power supply kit (cable length 2,2 m) - 230VAC-48VDC - IP20 - 321x91x111H - White - APP Compatible AQ17501APP

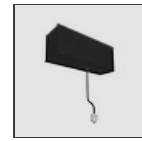

150W Ceiling power supply kit (cable length 2,2 m) - 230VAC-48VDC - IP20 - 321x91x111H - Black - APP Compatible AQ17504APP



240W Recessed power supply kit (cable length 2,2 m) - 230VAC-48VDC - IP20 - 396x195x112H - Black - DALI AQ15404



240W Ceiling power supply kit (cable length 2,2 m) - 230VAC-48VDC - IP20 - 321x91x111H - White - DALI AQ16101

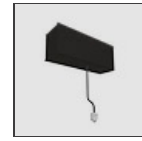

240W Ceiling power supply kit (cable length 2,2 m) - 230VAC-48VDC - IP20 - 321x91x111H - Black - DALI AQ16104



240W Remote box power supply kit (2 connectors) - 230VAC-48VDC - IP20 - 313x243x57,5H - DALI AQ16000



240W Remote box power supply kit (2 connectors) - 230VAC-48VDC - IP20 - 313x243x57,5H - APP Compatible AQ16000APP



240W Recessed power supply kit (cable length 2,2 m) - 230VAC-48VDC - IP20 - 396x195x112H - White - APP Compatible AQ15401APP



240W Recessed power supply kit (cable length 2,2 m) - 230VAC-48VDC - IP20 - 396x195x112H - Black - APP Compatible AQ15404APP



240W Ceiling power supply kit (cable length 2,2 m) - 230VAC-48VDC - IP20 - 321x91x111H - White - APP Compatible AQ16101APP



240W Recessed power supply kit (cable length 2,2 m) - 230VAC-48VDC - IP20 - 396x195x112H - White - DALI AQ15401

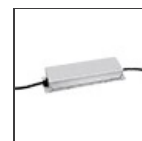

240W Bare power supply + plug 230VAC-48VDC IP20 -

Undimmable (for dimmable version to be combined with "DALI-Selv interface")

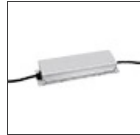

150W Bare power supply + plug
230VAC-48VDC
IP20 -
Undimmable (for dimmable version to be combined with "DALI-Selv interface")
AQ18100



A.24 - Suspension
- Insulating Spacer
- Use between modules powered by different power supplies (1pcs)
- Brushed Copper
AQ49118

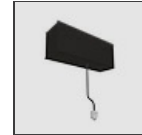

240W Ceiling power supply kit
(cable length 2,2 m) - 230VAC-48VDC - IP20 - 321x91x111H - Black - Undimmable
AQ17104



150W Ceiling power supply kit
(cable length 2,2 m) - 230VAC-48VDC - IP20 - 321x91x111H - White - Undimmable
AQ17601

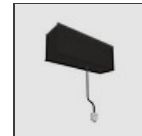

150W Ceiling power supply kit
(cable length 2,2 m) - 230VAC-48VDC - IP20 - 321x91x111H - Black - Undimmable
AQ17604



150W Ceiling power supply kit
(cable length 2,2 m) - 230VAC-48VDC - IP20 - 321x91x111H - White - DALI
AQ17501



150W Ceiling power supply kit
(cable length 2,2 m) - 230VAC-48VDC - IP20 - 321x91x111H - Black - DALI
AQ17504

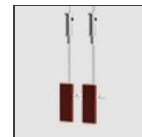

A.24 - Suspension
- End caps. (2pcs) including 1 suspension cable 200H - Brushed Copper
AQ49018



A.24 - Suspension
- Transition joint - Use between different typology modules (track-diffusing-sharpping) - Brushed Copper
AQ49418

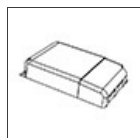

DALI to DALI-Selv Interface
103x67x21H
AQ18200



240W Recessed power supply kit
(cable length 2,2 m) - 230VAC-48VDC - IP20 - 396x195x112H - White - Undimmable
AQ17401



240W Recessed power supply kit
(cable length 2,2 m) - 230VAC-48VDC - IP20 - 396x195x112H - Black - Undimmable
AQ17404

240W Ceiling power supply kit
(cable length 2,2 m) - 230VAC-



48VDC - IP20 -
321x91x111H -
White -
Undimmable
AQ17101