

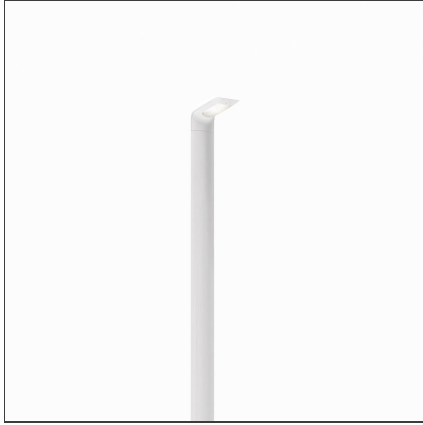

# Hila Pole 350 4000K Gray/white



IP65  

## DESIGN BY

Carlo Colombo

## DESCRIPTION

Composed by lamp and ground support pole.

Lamp unit is die-cast EN-AB 47100 aluminium.

UV resistant diffuser in shock resistant polycarbonate with satiny finish.

Support pole h=350cm above ground +50cm underground in extruded EN-AW 6060 aluminium, chromate treated and painted.

## TECHNICAL DRAWINGS

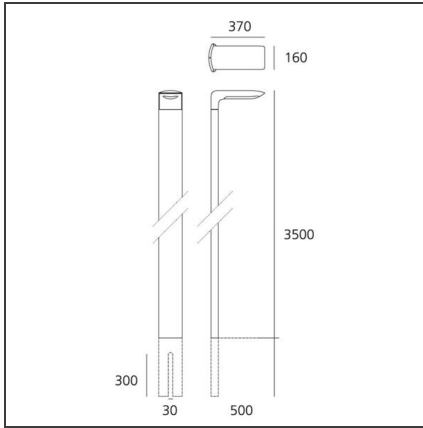

## FEATURES

<b>Article Code:</b>	T085900	<b>Material:</b>	Aluminum, polycarbonate
<b>Colour:</b>	Gray/white	<b>Series:</b>	Scenarios
<b>Installation:</b>	Bollard, Pole, Floor, Wall	<b>Emission:</b>	Direct
<b>Environment:</b>	Outdoor		

## DIMENSIONS

<b>Length:</b>	cm 37	<b>Impact Resistance:</b>	IK10
<b>Width:</b>	cm 16	<b>Glow Wire Test:</b>	650
<b>Height:</b>	cm 350		
<b>Depth:</b>	cm 30		

## INCLUDED SOURCES

<b>Category:</b>	LED	<b>Color temperature (K):</b>	4000K
<b>Number:</b>	1	<b>CRI:</b>	80
<b>Watt:</b>	24W		
<b>Type:</b>	0		
<b>Class:</b>	A		

## LUMINAIRE

<b>Watt:</b>	24W	<b>Delivered lumens output (lm):</b>	1311lm
<b>Voltage:</b>	220V-240V	<b>CCT:</b>	4000K
		<b>Efficiency:</b>	100%
		<b>Efficacy:</b>	54.62lm/W
		<b>CRI:</b>	80

## Notes

Underground pole included.  
Effective power 24W.

**LIGHT DISTRIBUTION**