

Hoy 3-Phase Track - Adjustable - 30° - 3000K - Undimmable - White



IP20   

DESIGN

Foster + Partners Industrial Design

BESCHREIBUNG

TECHNISCHE ZEICHNUNGEN

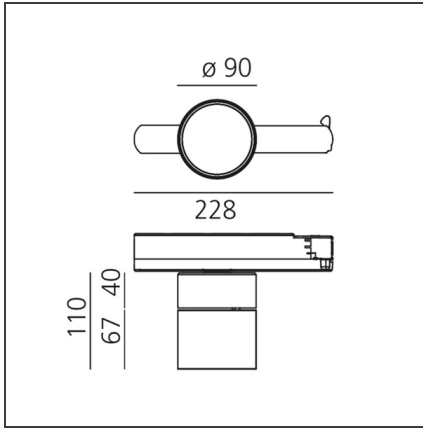

FUNKTIONEN

Artikelnummer:	BM21001	Serie:	Indoor
Farbe:	White		
Installation:	Stromschiene, Projector		
Anwendungsbereich:	Innenbeleuchtung		

DIMENSION

Länge:	cm 22,8
Höhe:	cm 11
Neigung:	90°
Drehung:	cm 360

INKLUSIVE LEUCHTMITTEL

Kategorie:	LED	Color Tolerance:	MacAdam 3SDCM
Anzahl:	1	Service Life:	L70 (6K) 50000h
Watt:	27W		
Typ:	0		

LUMINAIRE

Watt:	27W	Lichtstrom (lm):	1912lm
Spannung (V):	220-240V	CCT:	3000K
		CRI:	80

Anmerkungen

220/240Vac 50/60Hz electronic ballast included