

Hoy System - Spot Module - 44° - 4000K - Dimmable DALI - White

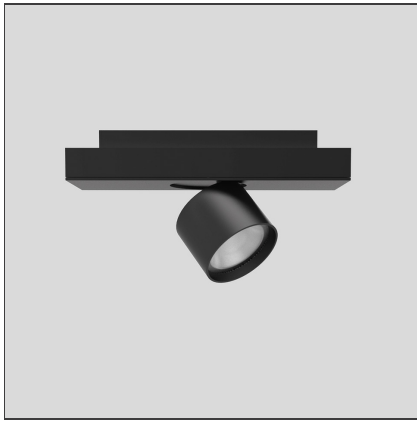

IP20   Dimmbar: 

DESIGN

Foster + Partners Industrial Design

TECHNISCHE ZEICHNUNGEN

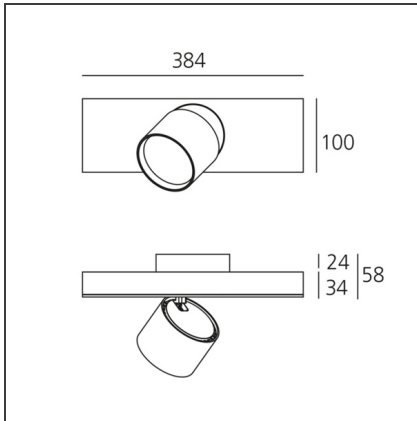

FUNKTIONEN

Artikelnummer:	BL30801	Serie:	Indoor
Farbe:	White		
Installation:	Deckenleuchte, Pendelleuchte		
Anwendungsbereich:	Innenbeleuchtung		

DIMENSION

Länge:	cm 38,4
Breite:	cm 10
Höhe:	cm 5,8
Neigung:	90°
Drehung:	cm 360

LUMINAIRE

Watt:	27W	Lichtstrom (lm):	1891lm
Spannung (V):	220-240V	CCT:	4000K
		CRI:	80
		Dimmable Typology:	Dali

Anmerkungen

220/240Vac 50/60Hz electronic ballast included

ZUBEHÖR



Ceiling intermediate feedable joint 2x90° including 2 transition joints - Black
BL21304



Power kit for suspension modules (3 poles cable L. 2.00m)
BL20401



Power kit for suspension modules (5 poles cable L. 2.00m)
BL20501



Power kit for ceiling modules (3/5 poles)
BL21400



Ceiling feedable end caps kit (x2) - Black
BL20604



Suspension intermediate feedable joint including 1 suspension cable and 1 transition joint - White
BL20201



Suspension intermediate feedable joint including 1 suspension cable and 1 transition joint - Black
BL20204



Ceiling intermediate feedable joint including 1 transition joint - White
BL20301



Ceiling intermediate feedable joint including 1 transition joint - Black
BL20304



Suspension intermediate feedable joint 2x90° including 1 suspension cable and 2 transition joints - White
BL21201



Suspension intermediate feedable joint 2x90° including 1 suspension cable and 2 transition joints - Black
BL21204



Ceiling intermediate feedable joint 2x90° including 2 transition joints - White
BL21301



Suspension feedable end caps kit including 2 suspension cable (x2) - White
BL20001



Suspension feedable end caps kit including 2 suspension cable (x2) - Black
BL20004

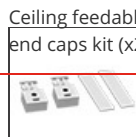

Ceiling feedable end caps kit (x2) -

White

