

M141720 - Airlite semirecessed stable white White 4000K 34°

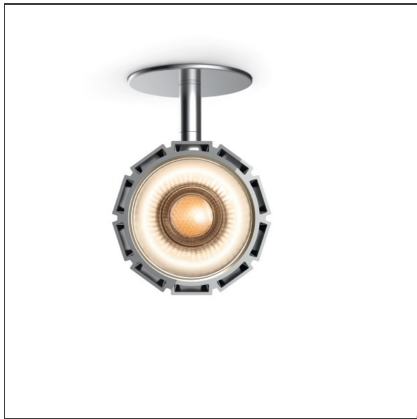

IP20 

DESIGN BY

Carlotta de Bevilacqua, Paola di Arianello

DESCRIPTION

Boasting elevated luminous flux, excellent colour rendering, energy efficiency, and a light compact design, Airlite is an innovative range of LED spotlights with exceptional photometric performance and flexibility. Thanks to an innovative heat dissipation system, air is filtered through open gaps in the die-cast aluminium body ensuring the efficiency and long life of our LED module. The hybrid optical system provides defined narrow beams, while keeping the light fixture dimensions compact.

TECHNICAL DRAWINGS

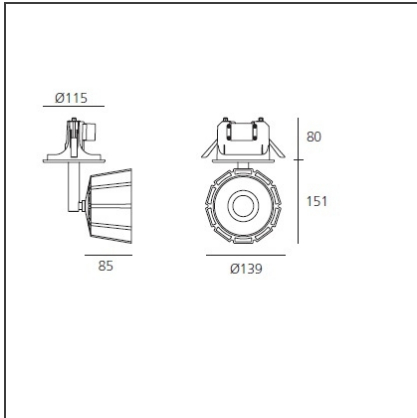

FEATURES

Article Code:	- - -	Material:	Aluminium
Colour:	White	Series:	Scenarios
Installation:	Projector, Recessed	Area contract:	Retail
		Emission:	Diretta orientabile

DIMENSIONS

Weight:	kg 1.3
Base Width:	cm 8

INCLUDED SOURCES

Category:	LED	Color temperature (K):	4000K
Number:	1	Color Tolerance:	MacAdam 3SDCM
Watt:	30W	CRI:	=80 (min.)
Delivered lumens output (lm):	3510 lm	Efficacy:	117 lm/W
Type:	0	Service Life:	L70(9K)>50000h
Class:	A		

LUMINAIRE

Watt:	35W	Delivered lumens output (lm):	3272lm
Voltage:	220-240V	CCT:	4000K
		Efficiency:	71%
		Efficacy:	93.49lm/W
		CRI:	90

ACCESSORIES

Portaccessori
M077820



Lente per
emissione ellittica
M078700

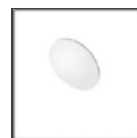

Filtro soft
M078800



Griglia frangiluce
M078400

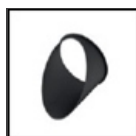

Paraluce
asimmetrico
M078500



Alette orientabili
M078600

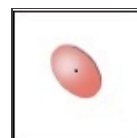

Filtro cromatico
M078900

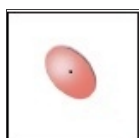

Filtro cromatico
M079000

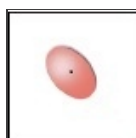

Filtro cromatico
M079100