

Mercury Mini Ceiling LED 2700K



IP20
 Dimmerable: + -

DESIGN BY

Ross Lovegrove

DESCRIPTION

Range extension of Mercury series, in smaller dimension. "A ceiling fixture that places a floating assembly of large pebbles below a simple modern disc. These in turn reflect each other bouncing light between their taugth bio - morphic surfaces and reflecting the environment around them. During the day the piece acts as a sculptural object reflecting the dynamics of natural light and the movement of people around them."
 Materials: structure in brushed stainless steel and painted aluminum. Light fixtures in chromed aluminium. Hanging in chromed plastic.

TECHNICAL DRAWINGS

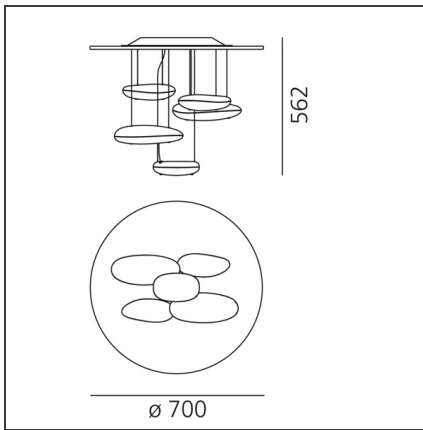

FEATURES

Article Code:	1476W10A	Material:	Aluminium, ABS, steel
Colour:	Polished chrome	Series:	Design, Hydro, Scenarios
Installation:	Suspension, Ceiling	Area contract:	Hospitality, Office, Residential
Environment:	Indoor	Emission:	Indirect

DIMENSIONS

Height:	cm 56.2	Glow Wire Test:	650
----------------	---------	------------------------	-----

INCLUDED SOURCES

Category:	LED	Color temperature (K):	2700K
Number:	1	Color Tolerance:	MacAdam 2SDCM
Watt:	29W	CRI:	90
Type:	0		
Class:	A		

LUMINAIRE

Watt:	29W	Delivered lumens output (lm):	1447lm
Voltage:	220V-240V	CCT:	2700K
		Efficiency:	54%
		Efficacy:	49.9lm/W
		CRI:	90
		Dimmable Typology:	Push