









Mercury Suspension LED 3000K



IP20       

Dimmerable: +  -

DESIGN BY

Ross Lovegrove

DESCRIPTION

A ceiling fixture that places a floating assembly of large pebbles below a simple modern aluminium disc. These in turn reflect each other bouncing light between their taugth bio - morphic surfaces and reflecting the environment around them. During the day the piece acts as a sculptural object reflecting the dynamics of natural light and the movement of people around them. Die-cast aluminium lighting units; reflective units made of injection-moulded thermoplastic material with metallic finish; stainless steel reflector. Dimmable (SwitchDim).

TECHNICAL DRAWINGS

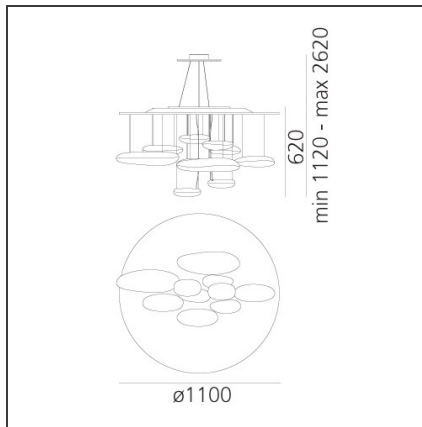

FEATURES

Article Code:	1367110A	Material:	Aluminium, ABS, steel
Colour:	Polished chrome	Series:	Design, Hydro, Scenarios
Installation:	Ceiling, Suspension	Area contract:	Hospitality, Office, Residential
Environment:	Indoor	Emission:	Indirect

DIMENSIONS

Height:	cm 60	Glow Wire Test:	650
Max Height from ceiling:	cm 200		

INCLUDED SOURCES

Category:	LED	Color temperature (K):	3000K
Number:	2	Color Tolerance:	MacAdam 2SDCM
Watt:	23.62W	CRI:	90
Delivered lumens output (lm):	2840lm	Efficacy:	120lm/W
Type:	0	Service Life:	50000-L70

LUMINAIRE

Watt:	58W	Delivered lumens output (lm):	3094lm
Voltage:	220V-240V	CCT:	3000K
		Efficiency:	54%
		Efficacy:	53.34lm/W
		CRI:	90
		Dimmable Typology:	Push

Notes

Its modular shape lends itself to the creation and realisation of customized compositions, supplied as special project.