

Pad for Algoritmo - 14,5W 4000K - 12°



IP40 

DESIGN BY

Carlotta de Bevilacqua

DESCRIPTION

Adjustable LED projector with a special plate for mounting into modules of Algoritmo. Body made from aluminium and translucent plastic material. White LED with Warm White or Neutral White tone. Choice of 3 beam angles. Tilt angle of up to 90°, rotation of up to 358°. Integral power supply unit. Complies with standard EN60598-1 and other specific standards.

TECHNICAL DRAWINGS

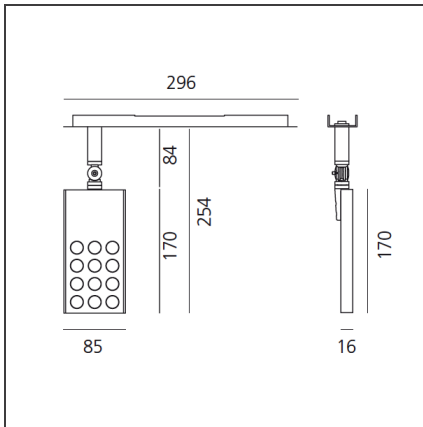

FEATURES

Article Code:	M200102	Material:	Aluminium
Colour:	Translucent/Bright anodized	Series:	Indoor
Installation:	Projector, Track, Recessed, Ceiling	Area contract:	Retail, Culture
Environment:	Indoor	Emission:	Accent Lighting

DIMENSIONS

Length:	cm 8.5	Glow Wire Test:	650
Width:	cm 1.6		
Height:	cm 17		
Weight:	kg 0.5		
Inclination:	cm 9,090		
Rotation:	cm 358		

INCLUDED SOURCES

Category:	LED	Color temperature (K):	4000K
Number:	1		
Watt:	12W		
Type:	0		
Class:	A		

LUMINAIRE

Power Supply:	Electronic Integrated	Delivered lumens output (lm):	880lm
Watt:	14.5W	CCT:	4000K
Voltage:	220V-240V	Efficiency:	100%
		Efficacy:	60.69lm/W
		CRI:	0

Notes

LED 13W 2x6° 4000K