

Pad Square Semi-recessed - 29W 4000K - 12°



IP40

DESIGN BY

Carlotta de Bevilacqua

DESCRIPTION

An extension of the PAD (POÈME DE L'ANGLE DROIT) concept, PAD SQUARE houses an array of 24 LEDs (26W in total) placed on the aluminium body that acts as heat dissipator. The special, patented electrical system houses the power supply within the shell, and allows a direct connection to the electrical network. A translucent cover in polycarbonate closes off the body. It acts as a support for the various lenses, ensures protection for the electrical parts and provides a diffused lighting effect. Rotation of up to 358°, tilt angle of up to 180°. 4 installation options: with adaptor for 3-circuit track, with gear plate for mounting within Algoritmo product range, wall/ceiling mounted version, or base plate for semi-recessed mounting. Complies with EN60598-1 and other specific standards.

TECHNICAL DRAWINGS

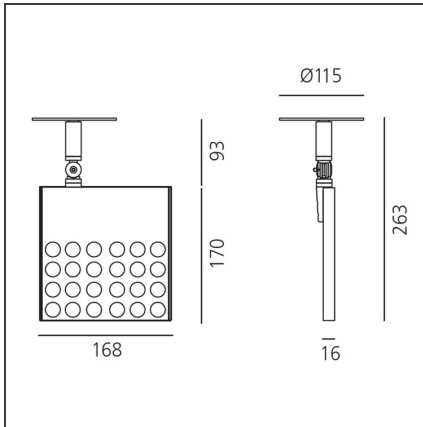

FEATURES

Article Code:	M201604	Material:	Aluminium, Polycarbonat
Colour:	translucent/anodized	Series:	Indoor
Installation:	Projector, Track, Recessed, Ceiling	Area contract:	Retail, Culture
		Emission:	Accent lighting

DIMENSIONS

Length:	cm 16.8	Glow Wire Test:	650°
Width:	cm 1.6		
Height:	cm 26.3		
Weight:	kg 1		
Inclination:	cm 9,090		
Rotation:	358°		
Depth:	cm 1.6		

INCLUDED SOURCES

Category:	LED	Color temperature (K):	4000K
Number:	1	Color Tolerance:	4SDCM
Watt:	24W	CRI:	=80(typ.)
Delivered lumens output (lm):	2120lm	Efficacy:	88lm/W
Type:	0	Service Life:	L70(14K)>81600h
Class:	A		

LUMINAIRE

Transformer availability:	Included (non dimmable)	Delivered lumens output (lm):	1760lm
Watt:	29.0W	CCT:	4000K
Voltage:	230-240V	Efficiency:	100%
		Efficacy:	60.69lm/W
		CRI:	0

Notes

LED 26W 2x6° 4000K