

## Vector Magnetic 20 - 32° 3000K DALI White

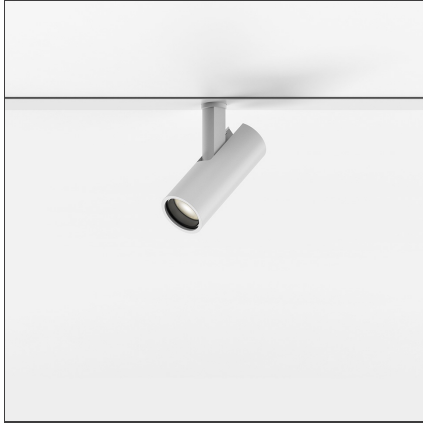

IP20  Dimmerable: 

### DESIGN BY

Carlotta de Bevilacqua

### DESCRIPTION

Four sizes with three different beam angles each (spot, flood, wide flood) obtained by means of refractive or hybrid optical units. Junction arm integrated in the spotlight's body to keep the barycentre aligned with the track and prevent any imbalance in possible suspension versions of the track. The junction allows 360° rotation and 90° tilting for maximum emission adjustment freedom.

### TECHNICAL DRAWINGS

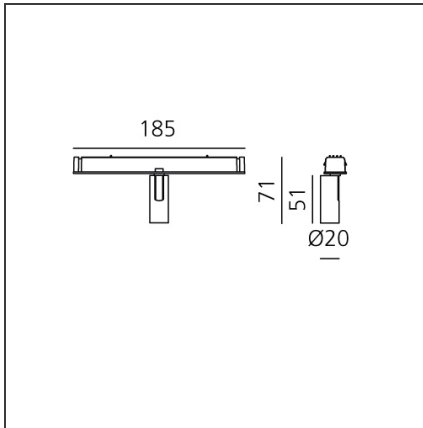

### FEATURES

|                      |                  |                |                                     |
|----------------------|------------------|----------------|-------------------------------------|
| <b>Article Code:</b> | AP70301          | <b>Series:</b> | Indoor, 2019<br>Artemide Collection |
| <b>Colour:</b>       | White            |                |                                     |
| <b>Installation:</b> | Track, Projector |                |                                     |
| <b>Environment:</b>  | Indoor           |                |                                     |

### DIMENSIONS

|                     |         |
|---------------------|---------|
| <b>Height:</b>      | cm 7.1  |
| <b>Base Length:</b> | cm 18.5 |
| <b>Inclination:</b> | -90+90  |
| <b>Rotation:</b>    | cm 360  |

### INCLUDED SOURCES

|                  |     |                               |                 |
|------------------|-----|-------------------------------|-----------------|
| <b>Category:</b> | LED | <b>Color temperature (K):</b> | 3000K           |
| <b>Number:</b>   | 1   | <b>Color Tolerance:</b>       | MacAdam 3SDCM   |
| <b>Watt:</b>     | 2W  | <b>CRI:</b>                   | 80              |
| <b>Type:</b>     | 0   | <b>Service Life:</b>          | L90 (6K) 36300h |

### LUMINAIRE

|              |    |                                      |       |
|--------------|----|--------------------------------------|-------|
| <b>Watt:</b> | 2W | <b>Delivered lumens output (lm):</b> | 140lm |
|              |    | <b>CCT:</b>                          | 3000K |
|              |    | <b>CRI:</b>                          | 80    |
|              |    | <b>Dimmable Typology:</b>            | Dali  |

### Notes

For operation use only Artemide Power Supply kit.