



Vector Magnetic 40 - 10W 28° 4000K DALI Brushed copper



IP20   Dimmbar: +  -

DESIGN

Carlotta de Bevilacqua

BESCHREIBUNG

Two sizes with three different beam angles each (spot, flood, wide flood) obtained by means of refractive or hybrid optical units. Junction arm integrated in the spotlight's body to keep the barycentre aligned with the track and prevent any imbalance in possible suspension versions of the track. The junction allows 360° rotation and 90° tilting for maximum emission adjustment freedom.

TECHNISCHE ZEICHNUNGEN

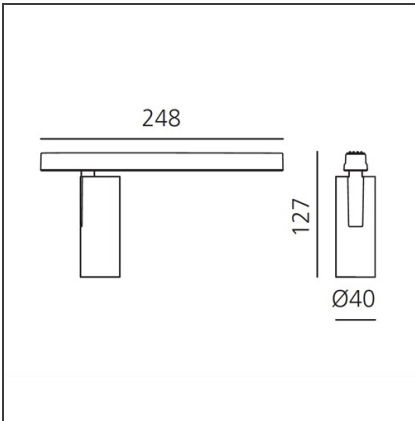

FUNKTIONEN

Artikelnummer:	AP05318	Serie:	Indoor, 2019 Artemide Collection
Farbe:	Brushed copper		
Installation:	Stromschiene, Projector		
Anwendungsbereich:	Innenbeleuchtung		

DIMENSION

Höhe:	cm 12.7
Gewicht:	kg 0.3
Länge Fuß:	cm 24.8
Neigung:	-90+90
Drehung:	cm 360

INKLUSIVE LEUCHTMITTEL

Kategorie:	LED	Farbtemperatur(K):	4000K
Anzahl:	1	Color Tolerance:	MacAdam 3SDCM
Watt:	10W	Service Life:	L70 (6K) 50000h
Typ:	0		
Class:	A		

LUMINAIRE

Watt:	10W	Lichtstrom (lm):	566lm
		CCT:	4000K
		Efficiency:	63%
		Efficacy:	56.65lm/W
		CRI:	90
		Dimmable Typology:	Dali

Anmerkungen

For operation use only Artemide Power Supply kit.

ZUBEHÖR

Accessories holder
- Vector 40
AP90100



Lens for elliptical
emission - Vector
40
AP90200



Soft filter - Vector
40
AP90300



Anti-dazzle louvre
- Vector 40
AP90400