

Vector Magnetic 55 - 26W 32° 4000K DALI Brushed copper



IP20   Dimmerable:  -

DESIGN BY

Carlotta de Bevilacqua

DESCRIPTION

Two sizes with three different beam angles each (spot, flood, wide flood) obtained by means of refractive or hybrid optical units. Junction arm integrated in the spotlight's body to keep the barycentre aligned with the track and prevent any imbalance in possible suspension versions of the track. The junction allows 360° rotation and 90° tilting for maximum emission adjustment freedom.

TECHNICAL DRAWINGS

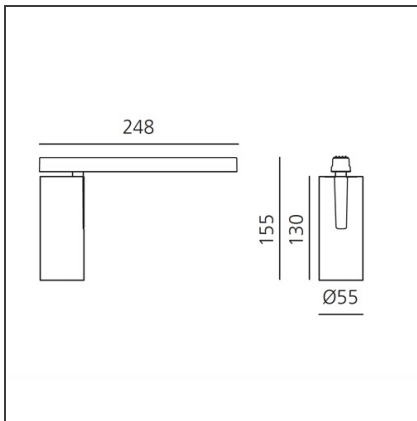

FEATURES

Article Code:	AP15318	Series:	Indoor, 2018
Colour:	Brushed copper		Artemide Collection
Installation:	Projector, Track		
Environment:	Indoor		

DIMENSIONS

Height:	cm 15.5
Base Length:	cm 24.8
Inclination:	-90+90
Rotation:	cm 360

INCLUDED SOURCES

Category:	LED	Color temperature (K):	4000K
Number:	1	Color Tolerance:	MacAdam 3SDCM
Watt:	26W	CRI:	90
Type:	0	Service Life:	L70 (6K) 50000h

LUMINAIRE

Watt:	26W	Delivered lumens output (lm):	1596lm
		CCT:	4000K
		Efficiency:	68%
		Efficacy:	61.41lm/W
		CRI:	90
		Dimmable Typology:	Dali

Notes

For operation use only Artemide Power Supply kit.

ACCESSORIES

Accessories holder
- Vector 55
AP91100



Lens for elliptical
emission - Vector
55
AP91200



Soft filter - Vector
55
AP91300



Anti-dazzle louvre
- Vector 55
AP91400



Adjustable
dowsers - Vector
55
AP91500