

Vector Recessed 55 - 16° 4000K Brushed Silver



IP20   

DESIGN BY

Carlotta de Bevilacqua

DESCRIPTION

Two sizes with three different beam angles each (spot, flood, wide flood) obtained by means of refractive or hybrid optical units. The junction allows 360° rotation and 90° tilting for maximum emission adjustment freedom. Vector 40 and 55 available version: recessed trim or trimless.

TECHNICAL DRAWINGS

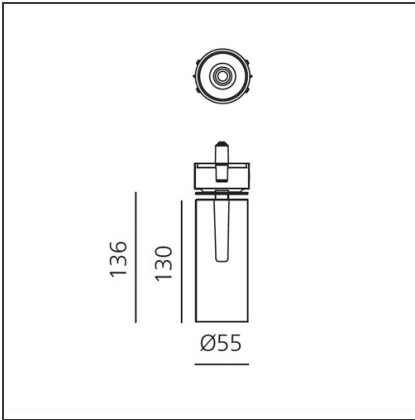

FEATURES

Article Code:	AP56115	Material:	Alluminium body
Colour:	Brushed Silver	Series:	Indoor
Installation:	Recessed, Projector		
Environment:	Indoor		

DIMENSIONS

Height:	cm 13.6	Cutout diameter:	cm 8.6
Inclination:	-90+90		
Rotation:	cm 360		

INCLUDED SOURCES

Category:	LED	Color temperature (K):	4000K
Number:	1	Color Tolerance:	MacAdam 3SDCM
Watt:	17,5W	CRI:	90
Type:	0	Service Life:	L70 (6K) 50000h

LUMINAIRE

Watt:	17.5W	Delivered lumens output (lm):	1268lm
		CCT:	4000K
		Efficiency:	64%
		Efficacy:	7.245.714.286lm/W
		CRI:	90

Notes

Trimless recessed structure not included, to be ordered separately. Driver 700/500mA SELV supplied separately. Depending on the driver, the product can be dimmable DALI or undimmable.

ACCESSORIES

Driver 15-36W
500-700mA - 220-
24Vac -
Undimmable -
146,5x43,5x22 mm
(LxWxH)
dv1030



Driver 11-25W
500-700mA - 220-
24Vac - Dimmable
DALI -
164x38x24,5 mm
(LxWxH)
dv1031

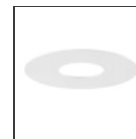

Vector 55 -
Optional Trim
Frame Ø 108 -
White
Ap59101

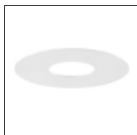

Vector 55 -
Optional Trim
Frame Ø 108 -
Black
Ap59104



Vector 40 -
Trimless recessed
structure
AP50000