

A.24 - Suspension Magnetic Track - Curved Joining Elements (not magnetic) - 750mm - 90° - Brushed Copper

Carlotta de Bevilacqua

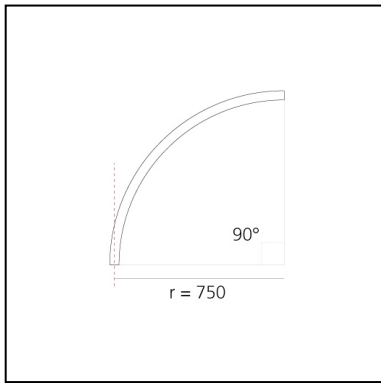

IP20   



Notes

Each linear, angle and curved elements are provided with mechanical and electrical joints and installation accessories. End caps have to be ordered separately. 1 suspension cable is also included. Depending on the driver, the product can be undimmable or dimmable DALI.

DESCRIPTION

A.24 is a new comprehensive and flexible system to design light in space. A single profile, only 24 mm thick, can be installed in the recessed, ceiling or suspension mode to continuously follow the angles on a flat or three-dimensional surface. This profile hosts to a variety of performance options: diffused light, sharp optical units with three beam angles, or a smart magnetic track. This makes A.24 a flexible system, as well as an open platform to accommodate other products from the Architectural collection. The suspension version also features direct emission. The three solutions can be alternated to match the architecture and the room functions with utmost flexibility. The competence of Artemide is revealed by the quality of light, as well as by the ability of A.24 to freely move in space, with direct power connection points up to 14 metres apart.

PRODUCT CODE: AQ73018

FEATURES

- Article Code: **AQ73018**
- Colour: **Brushed Copper**
- Installation: **Suspension**
- Series: **Architectural Indoor**
- Environment: **Indoor**
- design by: **Carlotta de Bevilacqua**

Accessories



240W Ceiling power supply kit (cable length 2,2 m) - 230VAC-48VDC - IP20 - 321x91x111H - Black - APP Compatible AQ16104APP



150W Ceiling power supply kit (cable length 2,2 m) - 230VAC-48VDC - IP20 - 321x91x111H - White - APP Compatible AQ17501APP

NO IMAGE AVAILABLE

4pcs feed connectors (for powering multiple sections with a single power kit) AQ90500



150W Ceiling power supply kit (cable length 2,2 m) - 230VAC-48VDC - IP20 - 321x91x111H - Black - APP Compatible AQ17504APP

NO IMAGE AVAILABLE

Power cable, 2x0.75 + 2x0.35, mm2 (to realized customized power cable) - 10m - White AQ90600

NO IMAGE AVAILABLE

Power cable, 2x0.75 + 2x0.35, mm2 (to realized customized power cable) - 50m - White AQ90700

NO IMAGE AVAILABLE

Power cable, 2x0.75 + 2x0.35, mm2 (to realized customized power cable) - 10m - Black AQ90800



240W Recessed power supply kit (cable length 2,2 m) - 230VAC-48VDC - IP20 - 396x195x112H - Black - DALI AQ15404

NO IMAGE AVAILABLE

Power cable, 2x0.75 + 2x0.35, mm2 (to realized customized power cable) - 50m - Black AQ90900



240W Ceiling power supply kit (cable length 2,2 m) - 230VAC-48VDC - IP20 - 321x91x111H - White - DALI AQ16101



240W Ceiling power supply kit (cable length 2,2 m) - 230VAC-48VDC - IP20 - 321x91x111H - Black - DALI AQ16104



240W Remote box power supply kit (2 connectors) - 230VAC-48VDC - IP20 - 313x243x57,5H - DALI AQ16000



240W Remote box power supply kit (2 connectors) - 230VAC-48VDC - IP20 - 313x243x57,5H - APP Compatible AQ16000APP



240W Recessed power supply kit (cable length 2,2 m) - 230VAC-48VDC - IP20 - 396x195x112H - White - APP Compatible AQ15401APP



240W Recessed power supply kit (cable length 2,2 m) - 230VAC-48VDC - IP20 - 396x195x112H - Black - APP Compatible AQ15404APP



240W Ceiling power supply kit (cable length 2,2 m) - 230VAC-48VDC - IP20 - 321x91x111H - White - APP Compatible AQ16101APP



240W Recessed power supply kit (cable length 2,2 m) - 230VAC-48VDC - IP20 - 396x195x112H - White - DALI AQ15401



240W Bare power supply + plug 230VAC-48VDC IP20 - Undimmable (for dimmable version to be combined with "DALI-Selv interface") AQ18000



150W Bare power supply + plug 230VAC-48VDC IP20 - Undimmable (for dimmable version to be combined with "DALI-Selv interface") AQ18100



A.24 - Suspension - Insulating Spacer - Use between modules powered by different power supplies (1pcs) - Brushed Copper AQ49118



240W Ceiling power supply kit (cable length 2,2 m) - 230VAC-48VDC - IP20 - 321x91x111H - Black - Undimmable AQ17104



150W Ceiling power supply kit (cable length 2,2 m) - 230VAC-48VDC - IP20 - 321x91x111H - White - Undimmable AQ17601



150W Ceiling power supply kit (cable length 2,2 m) - 230VAC-48VDC - IP20 - 321x91x111H - Black - Undimmable AQ17604



150W Ceiling power supply kit (cable length 2,2 m) - 230VAC-48VDC - IP20 - 321x91x111H - White - DALI AQ17501



150W Ceiling power supply kit (cable length 2,2 m) - 230VAC-48VDC - IP20 - 321x91x111H - Black - DALI AQ17504



A.24 - Suspension - End caps. (2pcs) including 1 suspension cable 200H - Brushed Copper AQ49018



Auxiliary suspension cable (to be used for S-configuration) (1 pcs) AQ49500



A.24 - Suspension - Transition joint - Use between different typology modules (track-diffusing-sharping) - Brushed Copper AQ49418



DALI to DALI-Selv Interface 103x67x21H AQ18200



240W Recessed power supply kit (cable length 2,2 m) - 230VAC-48VDC - IP20 - 396x195x112H - White - Undimmable AQ17401



240W Recessed power supply kit (cable length 2,2 m) - 230VAC-48VDC - IP20 - 396x195x112H - Black - Undimmable AQ17404



240W Ceiling power supply kit (cable length 2,2 m) - 230VAC-48VDC - IP20 - 321x91x111H - White - Undimmable AQ17101