

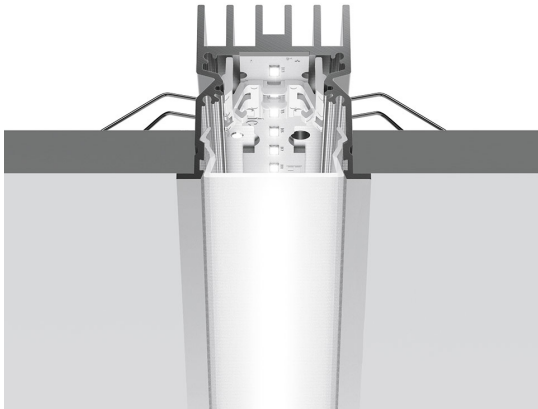

A.39 Incasso - Modulo Strutturale Trim 1184mm 4000K Non Dimmerabile Bianco

Carlotta de Bevilacqua

DESCRIZIONE

Versione ottimizzata per applicazioni in linea con grandi lunghezze. Emissione diffondente diretta e diretta + indiretta. Versioni incasso trim, trimless, sospensione e soffitto. Versione dimmerabile e non dimmerabile in due temperature di colore 3000K e 4000K.



IP20 

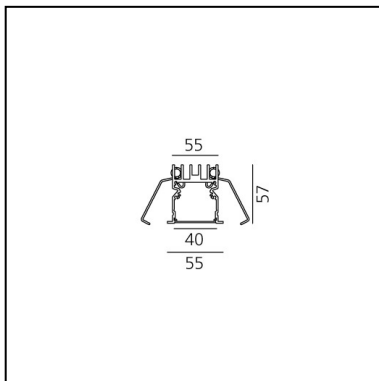

LUMINAIRE

- Watt : **33W**
- Flusso luminoso emesso: **2269lm**
- CCT: **4000K**
- Efficiency: **47%**
- Efficacy: **68.76lm/W**
- CRI: **80**

Note

Diffusore opalino fornito a parte.
Interfaccia APP fornita a parte.
Il driver APP esclude in funzionamento tramite DALI e viceversa.

CODICE PRODOTTO: AT05301

CARATTERISTICHE

- Codice articolo: **AT05301**
- Colore: **Bianco**
- Installazione: **Incasso**
- Serie: **Architectural Indoor**
- Ambiente di utilizzo: **Interni**
- Emissione: **Diretta**
- design by: **Carlotta de Bevilacqua**

DIMENSIONI

- Lunghezza: **cm 118**

SORGENTI INCLUSE

- Categoria: **Led**
- Numero: **1**
- Watt: **33W**
- Temperatura Colore (K): **4000K**
- Color Tolerance: **MacAdam 2SDCM**
- Service Life: **L70 (6K) 50000h**

Accessories



Interfaccia BLL remota per Artemide APP per moduli a soffitto dimmerabili (fino a 40 indirizzi) DV1054APP



A.39 - Diffusore Opalino Policarbonato - L=1184mm AT10100



A.39 - Diffusore Opalino Policarbonato - L=10000mm AT10000



A.39 Incasso - Kit testate terminali trim (Kit 2x) - Fino a 5m - Bianco AT09001



A.39 - Diffusore Opalino Policarbonato - L=2368mm AT10200



A.39 - Diffusore Opalino Policarbonato - L=25000mm AT10800



A.39 - Diffusore Opalino Policarbonato - L=50000mm AT10900



A.39 Incasso - Kit testate terminali trim (Kit 2x) - Fino a 15m - Bianco AT09101



A.39 Incasso - Kit testate terminali trim (Kit 2x) - Fino a 35m - Bianco AT09201



A.39 - Diffusore Opalino Policarbonato - L=2960mm AT10300