

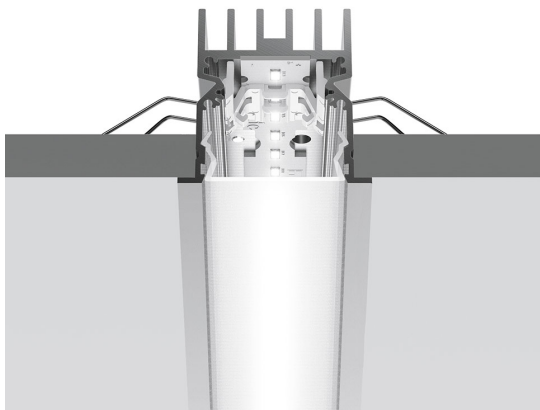

A.39 Incasso - Modulo Strutturale Trim 2960mm 4000K Non Dimmerabile Nero

Carlotta de Bevilacqua

DESCRIZIONE

Versione ottimizzata per applicazioni in linea con grandi lunghezze. Emissione diffondente diretta e diretta + indiretta. Versioni incasso trim, trimless, sospensione e soffitto. Versione dimmerabile e non dimmerabile in due temperature di colore 3000K e 4000K.



IP20 

CODICE PRODOTTO: AT07204

CARATTERISTICHE

- Codice articolo: **AT07204**
- Colore: **Nero**
- Installazione: **Incasso**
- Serie: **Architectural Indoor**
- Ambiente di utilizzo: **Interni**
- Emissione: **Diretta**
- design by: **Carlotta de Bevilacqua**

DIMENSIONI

- Lunghezza: **cm 296**

SORGENTI INCLUSE

- Categoria: **Led**
- Numero: **1**
- Watt: **81W**
- Temperatura Colore (K): **4000K**
- Color Tolerance: **MacAdam 2SDCM**
- Service Life: **L70 (6K) 50000h**

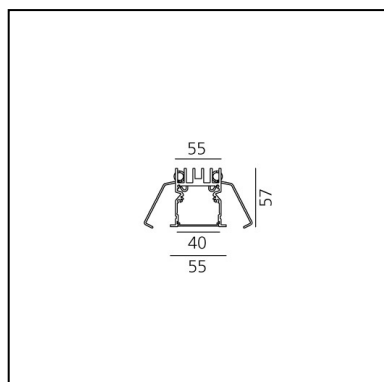

LUMINAIRE

- Watt : **81W**
- Flusso luminoso emesso: **5247lm**
- CCT: **4000K**
- Efficiency: **43%**
- Efficacy: **64.78lm/W**
- CRI: **80**

Note

Diffusore opalino fornito a parte.
Interfaccia APP fornita a parte.
Il driver APP esclude in funzionamento tramite DALI e viceversa.

Accessories



Interfaccia BLL remota per Artemide APP per moduli a soffitto dimmerabili (fino a 40 indirizzi) DV1054APP



A.39 - Diffusore Opalino Policarbonato - L=10000mm AT10000



A.39 Incasso - Kit testate terminali trim (Kit x2) - Fino a 5m - Nero AT09004



A.39 - Diffusore Opalino Policarbonato - L=1184mm AT10100



A.39 - Diffusore Opalino Policarbonato - L=2368mm AT10200



A.39 - Diffusore Opalino Policarbonato - L=25000mm AT10800



A.39 - Diffusore Opalino Policarbonato - L=50000mm AT10900



A.39 Incasso - Kit testate terminali (Kit 2x) - Fino a 15m - Nero AT09104



A.39 Incasso - Kit testate terminali trim (Kit 2x) - Fino a 35m - Nero AT09204



A.39 - Diffusore Opalino Policarbonato - L=2960mm AT10300