

Algoritmo Controlled - Prismoptic Emission - Structural module recessed - Trim 4736mm Silver

Carlotta de Bevilacqua
Paola di Arianello

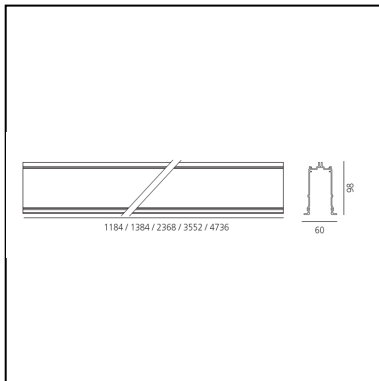
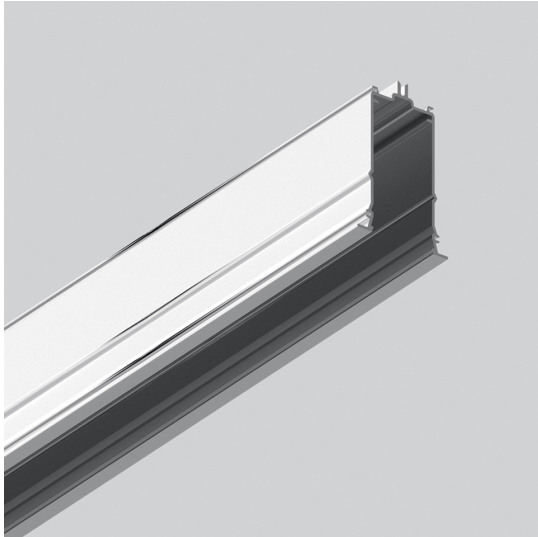

DESCRIPTION

A modular system for ceiling or wall-recessed installation, to be installed as a continuous line or with angles, composed of structural modules in extruded aluminium, of pre-wired gear plates with through-wiring and quick-connection system of optics systems and components for connecting, fixing, joining or finishing the system. The prewired LED plates were designed for diffused emission, wall washer light, prismoptic or controlled emission, for projectors integration (PAD or Cube 37), for 3 phase track alimentation. Complies with standard EN60598-1 and any other specific standard.

CARACTÉRISTIQUES

- Code Produit : **M293790**
- Couleur: **Silver**
- Installation: **Encastré**
- Séries: **Architectural Indoor**
- dessiné par: **Carlotta de Bevilacqua, Paola di Arianello**

DIMENSIONS

- Longueur : **4730 mm**

ACCESSOIRES



90° angle to mechanically connect two recessed modules on perpendicular plane - Silver (trim) M293890



90° joint. To mechanically connect two recessed modules on the same plane - Trim - Silver (To be ordered with kit cover angle cod. AE44001 / AE44004) M293990



End caps (set of 2) trim silver M294090