

Algoritmo Stand-Alone - Suspension - LED diffused emission - Direct + indirect emission - 62W 4000K DALI - White

Carlotta de Bevilacqua
Paola di Arianello

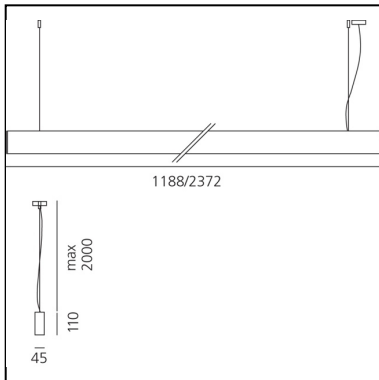

IP20  Dimmerable: 



LUMINAIRE

- Watt: **62W**
- Delivered lumens output: **4645lm**
- CCT: **4000K**
- Efficiency: **59%**
- Efficacy: **74.91lm/W**
- CRI: **80**
- Dimmable Typology: **Dali**

Notes

Only direct emission is dimmable. Upper screen in PMMA included.

DESCRIPTION

Series of single units, preconfigured and complete for suspension-mounting, wall-mounting and ceiling-mounting. Body in extruded aluminium, painted white. Two lengths available: 1188 mm and 2372mm. LED version direct emission, diffused: LED monochromatic warm white (3000 K) and neutral white (4000 K). Power supply and light management system included, non dimmable or Dali-SwitchDim. Suspended version direct or double emission. Luminaires come complete with end caps, fixing brackets or suspension cables and optics. Compliant with standard EN60598-1 and other specific standards.

PRODUCT CODE: M2911N21

FEATURES

- Article Code: **M2911N21**
- Colour: **White**
- Installation: **Suspension**
- Material: **Extruded Aluminium**
- Series: **Architectural Indoor**
- Environment: **Indoor**
- Emission: **Direct/indirect Diffused & Dark Light**
- design by: **Carlotta de Bevilacqua, Paola di Arianello**

DIMENSIONS

- Length: **cm 118**
- Width: **cm 4.5**
- Height: **cm 11**
- Weight: **kg 3.8**
- Glow Wire Test: **650°**

SOURCES INCLUDED

- Category: **Led**
- Number: **1**
- Watt: **62W**
- Color temperature (K): **4000K**
- Color Tolerance: **MacAdam 3SDCM**
- Service Life: **L70 (4K) 60500h**