



Ciclope Floor 90 Bilaterale Anthracite gray

Alessandro Pedretti



IP65   

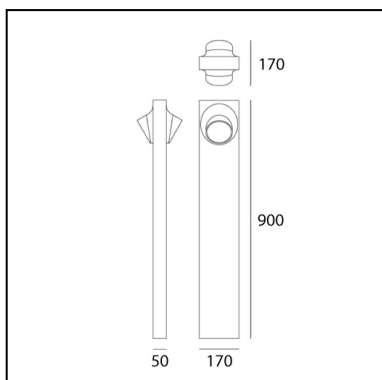

LUMINARIA

- Potencia (W): **13W**
- Tensión de alimentación: **220-240V**
- Flujo Luminoso (lm): **765lm**
- CCT: **3000K**
- Efficiency: **64%**
- Efficacy: **58.88lm/W**
- CRI: **90**

ESPECIFICACIONES

Lighting system with diffuse unilateral or bilateral emission, with high-performance LED light sources. Light emission is obtained by the combination of six monochromatic LED light sources, a reflector and an opaline diffuser. Floor, wall or recessed installation. Available in two finishes: light grey and rust painted.

CÓDIGO PRODUCTO: T081420

CARACTERÍSTICAS

- Código del artículo: **T081420**
- Color: **Anthracite gray**
- Instalación: **FocosPie**
- Material: **Composite technopolymer, polycarbonate, steel, aluminum**
- Serie: **Architectural Outdoor**
- Entorno de uso: **Exterior**
- Área de uso: **null, Outdoor, Residential**
- Emisión: **Directa**
- diseño: **Alessandro Pedretti**

DIMENSIONES

- Longitud: **cm 17**
- Ancho: **cm 17**
- Altura: **cm 90**

FUENTES DE LUZ INCLUIDAS

- Categoría: **Led**
- Numero: **2**
- Potencia (W): **6,5W**
- Temperatura de Color (K): **3000K**
- CRI: **80**