

Ciclope Floor 90 Monolaterale

Anthracite gray

Alessandro Pedretti

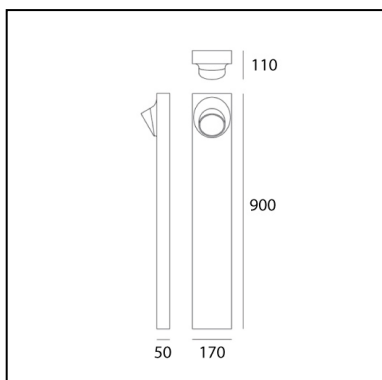

LUMINAIRE

- Power Supply: **Electronic**
- Watt: **6,5W**
- Voltage: **220-240V**
- Delivered lumens output: **383lm**
- CCT: **3000K**
- Efficiency: **64%**
- Efficacy: **63.79lm/W**
- CRI: **90**

DESCRIPTION

Lighting system with diffuse unilateral or bilateral emission, with high-performance LED light sources. Light emission is obtained by the combination of six monochromatic LED light sources, a reflector and an opaline diffuser. Floor, wall or recessed installation. Available in two finishes: light grey and rust painted.

PRODUCT CODE: T081120

FEATURES

- Article Code: **T081120**
- Colour: **Anthracite gray**
- Installation: **BollardFloor**
- Material: **Composite technopolymer, polycarbonate, steel, aluminum**
- Series: **Architectural Outdoor**
- Environment: **Outdoor**
- Area contract: **null, Outdoor, Residential**
- Emission: **Direct**
- design by: **Alessandro Pedretti**

DIMENSIONS

- Length: **cm 17**
- Width: **cm 11**
- Height: **cm 90**

SOURCES INCLUDED

- Category: **Led**
- Number: **1**
- Watt: **6,5W**
- Color temperature (K): **3000K**
- CRI: **80**