

# Everything 150 - Round - Trimless - 28° 3000K - Polished Metal

Ernesto Gismondi



## DESCRIPTION

Everything is an innovative range of professional recessed light fittings created to deliver a high lighting performance, with an eye on energy saving and excellent visual comfort. A complete, flexible product range, extremely versatile in its many applications and able to meet challenging lighting performance criteria.

APP Compatible version on request.

IP 20/44 

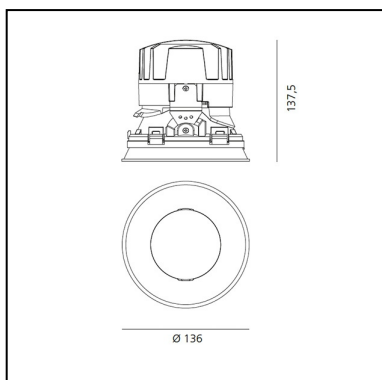

## LUMINAIRE

- Watt: **24W**
- Flux Lumineux (lm): **1893lm**
- CCT: **3000K**
- Efficiency: **69%**
- Efficacy: **78.86lm/W**
- CRI: **90**

## Remarques

Driver 700mA SELV supplied separately.  
Fitting to be completed with installation frame for recessing into ceiling.  
Geo-LiFi Compatible

## CARACTÉRISTIQUES

- Code Produit : **M262600**
- Couleur: **Polished Metal**
- Installation: **Encastré**
- Matériaux: **aluminium**
- Séries: **Architectural Indoor**
- dessiné par: **Ernesto Gismondi**

## DIMENSIONS

- Diamètre: **136 mm**
- Diamètre d'encastrement: **136 mm**
- Profondeur de la découpe: **137 mm**
- Rotation: **360°**
- Forme de la découpe: **Rond**
- Poids: **kg 0,3**
- Test au fil incandescent: **850°**
- Trou d'encastrement: **Thickness 1mm - 13mm**  
**(10mm - 25mm without spacers)**

## SOURCES INCLUES

- Catégorie: **Led**
- Nombre: **1**
- Watt: **24,4W**
- Température de Couleur (K): **3000K**
- Color Tolerance: **MacAdam 3SDCM**
- Service Life: **L80 (9K) 50000h**

**ACCESSOIRES**

NO  
IMAGE  
AVAILABLE

Driver cc 32-36W - 700mA - 220-240 Vac -  
103x67x21 (LxWxH) - Dimmable DALI M079200

NO  
IMAGE  
AVAILABLE

DRIVER cc 32-36W - 700mA - 220-240 - 103x67x21  
(LxWxH) - Dimmable PUSH/1-10V M079300



Remote BLL interface for Artemide App to  
manage dimmable ceiling modules (up to 40  
addresses) DV1054APP



Round frame for recessed installation M274800



Power Kit Geo-LiFi - CC Mod=50% - 230x80x25h -  
Undimmable VLCcoding - The nominal flux for this  
application is halved DV1060

NO  
IMAGE  
AVAILABLE

DRIVER cc 30W 700mA 220-240 165 43 30 1max  
Non dimmable M076800