

Everything 150 - Square - Trimless - Adj - 28° 2700K - Black

Ernesto Gismondi



DESCRIPTION

Everything is an innovative range of professional recessed light fittings created to deliver a high lighting performance, with an eye on energy saving and excellent visual comfort. A complete, flexible product range, extremely versatile in its many applications and able to meet challenging lighting performance criteria. APP Compatible version on request.

IP 20/44 

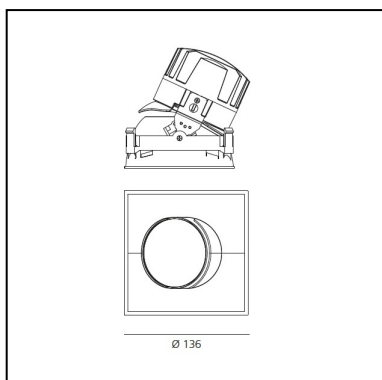

LUMINAIRE

- Watt: **24W**
- Flux Lumineux (lm): **1727lm**
- CCT: **2700K**
- Efficiency: **65%**
- Efficacy: **71.97lm/W**
- CRI: **90**

Remarques

Driver 700mA SELV supplied separately.
Fitting to be completed with installation frame for recessing into ceiling.
Geo-LiFi Compatible

CARACTÉRISTIQUES

- Code Produit : **M325205**
- Couleur: **Black**
- Installation: **Encastré**
- Matériaux: **aluminium**
- Séries: **Architectural Indoor**
- dessiné par: **Ernesto Gismondi**

DIMENSIONS

- Longueur : **136 mm**
- Largeur: **136 mm**
- Largeur de découpe: **136 mm**
- Longueur de découpe: **136 mm**
- Profondeur de la découpe: **137 mm**
- Inclinaison: **30°**
- Rotation: **360°**
- Forme de la découpe: **Carré**
- Poids: **kg 0,3**
- Test au fil incandescent: **850°**
- Trou d'encastrement: **Thickness 1mm - 13mm
(10mm - 25mm without spacers)**

SOURCES INCLUES

- Catégorie: **Led**
- Nombre: **1**
- Watt: **24,4W**
- Température de Couleur (K): **2700K**
- Color Tolerance: **MacAdam 3SDCM**
- Service Life: **L80 (9K) 50000h**

ACCESSOIRES

NO
IMAGE
AVAILABLE

Driver cc 32-36W - 700mA - 220-240 Vac -
103x67x21 (LxWxH) - Dimmable DALI M079200



Square frame for recessed installation M274900

NO
IMAGE
AVAILABLE

DRIVER cc 32-36W - 700mA - 220-240 -
103x67x21 (LxWxH) - Dimmable PUSH/1-10V
M079300



Remote BLL interface for Artemide App to manage
dimmmable ceiling modules (up to 40 addresses)
DV1054APP



Power Kit Geo-LiFi - CC Mod=50% - 230x80x25h -
Undimmable VLCcoding - The nominal flux for this
application is halved DV1060

NO
IMAGE
AVAILABLE

DRIVER cc 30W 700mA 220-240 165 43 30 1max
Non dimmable M076800