

# Hoy 3-Phase Track - 48° - 4000K - Undimmable - White

Foster + Partners Industrial  
Design

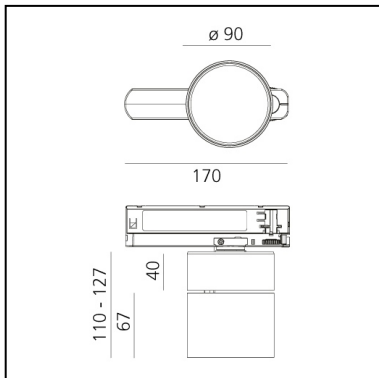

IP20   



## LUMINAIRE

- Watt: **22W**
- Tension: **220-240V**
- Flux Lumineux (lm): **2203lm**
- CCT: **4000K**
- Efficiency: **85%**
- Efficacy: **100.12lm/W**
- CRI: **90**

## Remarques

220/240Vac 50/60Hz electronic ballast included

## DESCRIPTION

Hoy is a system of adjustable spotlights with a basic shape, yet a rich performance. A simple cylinder protrudes from the surface with varying heights for the different versions (recessed, semi-recessed, SMD, track).

Its volume is divided to direct emission in space, the mobile part hosts to the source and the optical devices required to produce four different beam angles (13°, 24°, 48°, 68°).

## CARACTÉRISTIQUES

- Code Produit : **BM22001**
- Couleur: **White**
- Installation: **RailProjecteur**
- Séries: **Architectural Indoor**
- Environnement: **Indoor**
- dessiné par: **Foster + Partners Industrial Design**

## DIMENSIONS

- Longueur : **170 mm**
- Hauteur: **110 mm**
- Diamètre: **90 mm**
- Inclinaison: **90°**
- Rotation: **3600 mm°**

## SOURCES INCLUES

- Catégorie: **Led**
- Nombre: **1**
- Watt: **26W**
- Color Tolerance: **MacAdam 3SDCM**
- Service Life: **L70 (6K) 50000h**