

Hoy Spot - Recessed - 48° - 4000K

Foster + Partners Industrial Design



CARACTÉRISTIQUES



- Code Produit : **BM03800**
- Installation: **Encastré**
- Séries: **Architectural Indoor**
- Environnement: **Indoor**
- dessiné par: **Foster + Partners Industrial Design**

DIMENSIONS

- Diamètre: **85 mm**
- Diamètre d'encastrement: **95 mm**
- Profondeur de la découpe: **148 mm**
- Forme de la découpe: **Rond**

SOURCES INCLUES

- Catégorie: **Led**
- Nombre: **1**
- Watt: **19W**
- Color Tolerance: **MacAdam 3SDCM**
- Service Life: **L70 (6K) 50000h**

IP20   

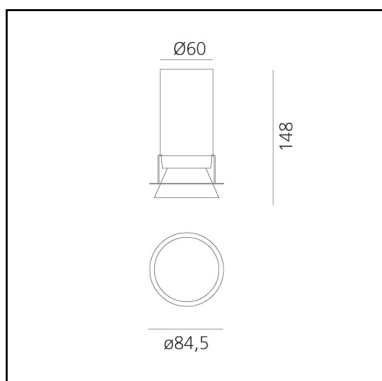

LUMINAIRE

- Watt: **19W**
- Tension: **220-240V**
- Flux Lumineux (lm): **2203lm**
- CCT: **4000K**
- Efficiency: **85%**
- Efficacy: **115.93lm/W**
- CRI: **90**

Remarques

Driver supplied separately.
Fitting to be completed with installation frame.

ACCESSOIRES

NO
IMAGE
AVAILABLE

Driver cc 32-36W - 700mA - 220-240 Vac -
103x67x21 (LxWxH) - Dimmable DALI M079200

NO
IMAGE
AVAILABLE

DRIVER cc 32-36W - 700mA - 220-240 - 103x67x21
(LxWxH) - Dimmable PUSH/1-10V M079300



Driver 15-36W 500-700mA - 220-24Vac -
146,5x43,5x22 mm (LxWxH) - Undimmable
dv1030

NO
IMAGE
AVAILABLE

Driver 23W 550mA - 220-24Vac - 146,5x43,5x22
mm (LxWxH) - APP Dimmable DV1062APP



Trimless Frame BM05000



Trim Frame - 105mm - White BM05101



Trim Frame - 105mm - Black BM05104