

M141110 - Airlite binario stable white Noir 3000K 34°

Carlotta de Bevilacqua
Paola di Arianello

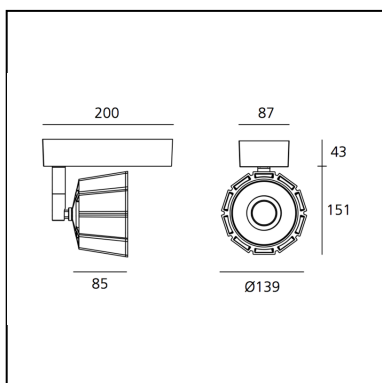

IP20  



LUMINAIRE

- Watt: **35W**
- Tension: **220-240 V**
- Flux Lumineux (lm): **3052lm**
- CCT: **3000K**
- Efficiency: **71%**
- Efficacy: **87.2lm/W**
- CRI: **90**

CODE PRODUIT: SCENARIOS

CARACTÉRISTIQUES

- Code Article : **M141110**
- Couleur: **Noir**
- Installation: **RailProjecteur**
- Matériaux: **Aluminium**
- Séries: **Scenarios**
- Type de projet: **Commerces**
- dessiné par: **Carlotta de Bevilacqua, Paola di Arianello**

DIMENSIONS

- Diamètre: **cm 13.9**
- Largeur de la base: **cm 20**
- Base Width: **cm 8.7**
- Diamètre d'encastrement: **cm 9.9**
- Poids: **kg 1.6**

SOURCES INCLUES

- Catégorie: **Led**
- Nombre: **1**
- Watt: **30W**
- Flux Lumineux (lm): **3310 lm**
- Température de Couleur (K): **3000K**
- CRI: **=80 (min.)**
- Color Tolerance: **MacAdam 3SDCM**
- Efficacy: **110 lm/W**
- Service Life: **L70(9K)>50000h**

ACCESSOIRES



Portaccessori M077810



Lente per emissione ellittica M078700



Filtro soft M078800



Griglia frangiluce M078400



Paraluce asimmetrico M078500



Alette orientabili M078600



Filtro cromatico M078900



Filtro cromatico M079000



Filtro cromatico M079100