

# Sharp - 2 optic unit - 5,5W - 52° 3000K Trimless

Carlotta de Bevilacqua

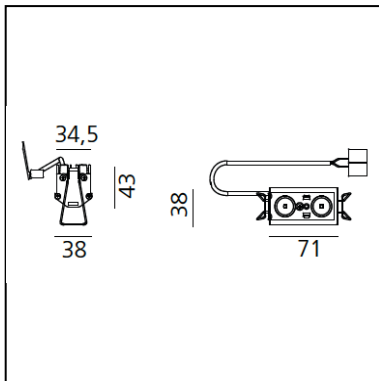

IP20  



## LUMINAIRE

- Watt: **5,5W**
- Delivered lumens output: **389lm**
- CCT: **3000K**
- Efficiency: **73%**
- Efficacy: **77.89lm/W**
- CRI: **90**

## Notes

Driver 900mA SELV and louvres supplied separately. (Required for installation)

## DESCRIPTION

High-efficiency patented optical system that combines polynomial perspective to an element that shields geometrically the angle of vision of the beam. High uniformity of illumination and full emission control. Complete absence of possible light flaws as stains and multi-shadows. Recessed depth 60 mm. Suitable for a ceiling of 1 to 25 mm. Available in trim versions, trimless and SMD.

**PRODUCT CODE: AF55500**

## FEATURES

- Article Code: **AF55500**
- Installation: **Recessed**
- Series: **Architectural Indoor**
- Environment: **Indoor**
- design by: **Carlotta de Bevilacqua**

## DIMENSIONS

- Length: **cm 7.1**
- Width: **cm 4.3**
- Height: **cm 3.8**

## SOURCES INCLUDED

- Category: **Led**
- Number: **1**
- Watt: **5,5W**
- Color Tolerance: **MacAdam 2SDCM**
- Service Life: **L90 (17K) 103000h**

**Accessories**

NO  
IMAGE  
AVAILABLE

Driver 7,2W 900mA - 220-240Vac - 76x32x22 (LxWxH) - 1x/2x Optic Units - Min Ceiling depth 80/60mm - Undimmable DV1001

NO  
IMAGE  
AVAILABLE

Driver 25W - 220-240Vac - 164x38x25 (LxWxH) - Dimmable DALI/PUSH DV1003



Screen 2x White AF95101



Screen 2x Black AF95104



Recessed frame 2x AF90100



Sharping wall grazer lens Kit (4pcs) - 26°x70° elliptical lenses kit. It has to be used on top of S 20° reflectors to get an elliptical beam (greter axis along the module lenght). It contains 4 lenses. AF06000