

# Sharp - 4 optic unit - 11W - 20° 3000K Trimless

Carlotta de Bevilacqua

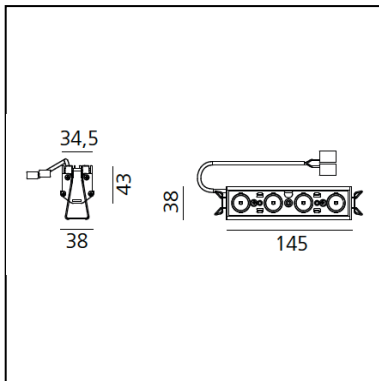

IP20  



## LUMINAIRE

- Watt: **11W**
- Delivered lumens output: **804lm**
- CCT: **3000K**
- Efficiency: **76%**
- Efficacy: **73.08lm/W**
- CRI: **90**

## Notes

Driver 900mA SELV and louvres supplied separately. (Required for installation)

## DESCRIPTION

High-efficiency patented optical system that combines polynomial perspective to an element that shields geometrically the angle of vision of the beam. High uniformity of illumination and full emission control. Complete absence of possible light flaws as stains and multi-shadows. Recessed depth 60 mm. Suitable for a ceiling of 1 to 25 mm. Available in trim versions, trimless and SMD.

**PRODUCT CODE: AF60300**

## FEATURES

- Article Code: **AF60300**
- Installation: **Recessed**
- Series: **Architectural Indoor**
- Environment: **Indoor**
- design by: **Carlotta de Bevilacqua**

## DIMENSIONS

- Length: **cm 14.5**
- Width: **cm 4.3**
- Height: **cm 3.8**

## SOURCES INCLUDED

- Category: **Led**
- Number: **1**
- Watt: **11W**
- Color Tolerance: **MacAdam 2SDCM**
- Service Life: **L90 (17K) 103000h**

**Accessories**

NO  
IMAGE  
AVAILABLE

Driver 25W - 220-240Vac - 164x38x25 (LxWxH) -  
Dimmable DALI/PUSH DV1003



Louvres 4x White AF95201



Louvres 4x Black AF95204

NO  
IMAGE  
AVAILABLE

Driver 19,8W 900mA - 220-240Vac - 125x38x23  
(LxWxH) - 4x Optic Units - Min Ceiling depth 60mm -  
Undimmable DV1002



Recessed frame 4x AF90200



Sharping wall grazer lens Kit (4pcs) - 26°x70°  
elliptical lenses kit. It has to be used on top of S 20°  
reflectors to get an elliptical beam (greter axis along  
the module lenght). It contains 4 lenses. AF06000

NO  
IMAGE  
AVAILABLE

Driver 16/20/23/25/28/32W - 900mA - 220-240  
156x52x26 (LxWxH) Dimmable DALI PUSH/1-  
10V/0-10V M077401

NO  
IMAGE  
AVAILABLE

Driver 20W 900mA - 220-240Vac - 180x32x32  
(LxWxH) - 4x Optic Units - Min Ceiling depth 80mm -  
DALI DV1008