

Sharp - 8 optic unit - 22W - 36° 4000K Trim Silver

Carlotta de Bevilacqua

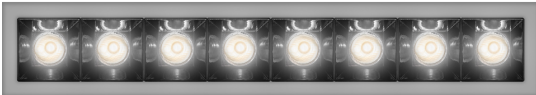

IP20  

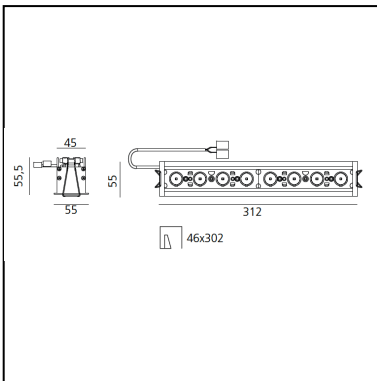

LUMINAIRE

- Watt: **22W**
- Delivered lumens output: **1610lm**
- CCT: **4000K**
- Efficiency: **71%**
- Efficacy: **73.19lm/W**
- CRI: **90**

Notes

Driver 900mA SELV and louvres supplied separately. (Required for installation)

DESCRIPTION

High-efficiency patented optical system that combines polynomial perspective to an element that shields geometrically the angle of vision of the beam. High uniformity of illumination and full emission control. Complete absence of possible light flaws as stains and multi-shadows. Recessed depth 60 mm. Suitable for a ceiling of 1 to 25 mm. Available in trim versions, trimless and SMD.

PRODUCT CODE: AF15405

FEATURES

- Article Code: **AF15405**
- Colour: **Silver**
- Installation: **Recessed**
- Series: **Architectural Indoor**
- Environment: **Indoor**
- design by: **Carlotta de Bevilacqua**

DIMENSIONS

- Length: **cm 31.2**
- Width: **cm 5.5**
- Height: **cm 5.5**

SOURCES INCLUDED

- Category: **Led**
- Number: **1**
- Watt: **22W**
- Color Tolerance: **MacAdam 2SDCM**
- Service Life: **L90 (17K) 103000h**

Accessories



Louvres 4x White AF95201



Louvres 4x Black AF95204

NO
IMAGE
AVAILABLE

Driver 32W 1000mA - 220-240Vac - 130x42x30 (LxWxH) - 8x Optic Units - Min Ceiling depth 80mm - Undimmable DV1004

NO
IMAGE
AVAILABLE

Driver 40W 900mA - 220-240Vac - 97x43x30 (LxWxH) - 8x/16x Optic Units - Min Ceiling depth 80mm - Undimmable DV1006

NO
IMAGE
AVAILABLE

Driver 25W - 220-240Vac - 164x38x25 (LxWxH) - Dimmable DALI/PUSH DV1003



Sharping wall grazer lens Kit (4pcs) - 26°x70° elliptical lenses kit. It has to be used on top of S 20° reflectors to get an elliptical beam (greter axis along the module lenght). It contains 4 lenses. AF06000

NO
IMAGE
AVAILABLE

Driver 16/20/23/25/28/32W - 900mA - 220-240 156x52x26 (LxWxH) Dimmable DALI PUSH/1-10V/0-10V M077401

NO
IMAGE
AVAILABLE

Driver 48W - 900mA - 220-240 125x82x29 (LxWxH) Dimmable DALI PUSH/1-10V/0-10V DV1063