

Tagora Suspension 970 - Direct Emission - dimmable - Beige/White

S./R. Cornelissen

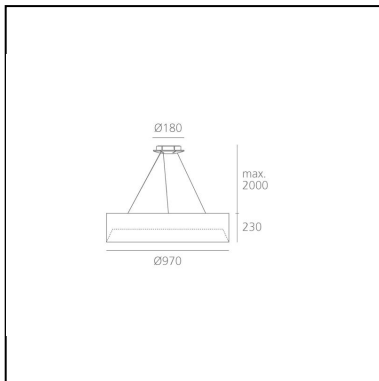

IP20  Dimmbar: 



LUMINAIRE

- Power Supply: **220/240Vac 50/60Hz electronic ballast included**
- Watt: **84W**
- Spannung (V): **220V-240V**
- Lichtstrom (lm): **6915lm**
- CCT: **4000K**
- Efficiency: **54%**
- Efficacy: **82.32lm/W**
- CRI: **80**
- Dimmable Typology: **Dali**

BESCHREIBUNG

Series of suspended luminaires available in 4 diameters (80 mm, 270 mm, 570 mm, 970 mm), using high-output LEDs, Retrofit LEDs. Aluminium body available in different two-coloured versions: beige/white, grey/white, black/orange, black/green and black/blue. Steel suspension cables allowing quick adjustment, 2 metre length. Tagora 80 and 270 offer a high-output spot light with aluminium optics. Tagora 270 uses a proprietary system based on a hybrid combined lens and reflector optic. This system helps to create defined narrow beams using high-powered LED modules of large dimensions. Tagora 570 and 970 come with a PMMA diffuser, offering a comfortable diffused light. LED versions use high-output sources. Integrated electronic power supply, dimmable or non-dimmable options, depending on the version. Compliant with standard EN60598-1 and other specific standards.

ARTIKELNUMMER: M248921

FUNKTIONEN

- Artikelnummer: **M248921**
- Farbe: **Beige/Weiss**
- Material: **Aluminium**
- Serie: **Architectural Indoor**
- design: **S./R. Cornelissen**

DIMENSION

- Höhe: **cm 23**
- Breite: **cm 97**
- Gewicht: **kg 21**
- Glühdrahttest: **960°**

INKLUSIVE LICHTQUELLEN

- Kategorie: **Led**
- Anzahl: **1**
- Watt: **84W**
- Farbtemperatur(K): **4000K**
- CRI: **80**
- Color Tolerance: **MacAdam 3SDCM**
- Service Life: **L70 (6K) 50000h**