

# Tagora Suspension 970 - Direct + Indirect Emission - dimmable - Black/Green

S./R. Cornelissen

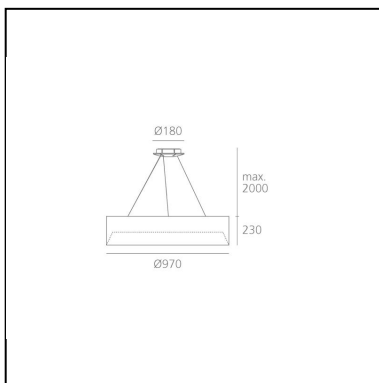

IP20  Dimmerable: 



## LUMINAIRE

- Power Supply: **220/240Vac 50/60Hz electronic ballast included**
- Watt: **95W**
- Voltage: **220V-240V**
- Delivered lumens output: **7538lm**
- CCT: **3000K**
- Efficiency: **52%**
- Efficacy: **79.35lm/W**
- CRI: **80**
- Dimmable Typology: **Dali**

## DESCRIPTION

Series of suspended luminaires available in 4 diameters (80 mm, 270 mm, 570 mm, 970 mm), using high-output LEDs, Retrofit LEDs. Aluminium body available in different two-coloured versions: beige/white, grey/white, black/orange, black/green and black/blue. Steel suspension cables allowing quick adjustment, 2 metre length. Tagora 80 and 270 offer a high-output spot light with aluminium optics. Tagora 270 uses a proprietary system based on a hybrid combined lens and reflector optic. This system helps to create defined narrow beams using high-powered LED modules of large dimensions. Tagora 570 and 970 come with a PMMA diffuser, offering a comfortable diffused light. LED versions use high-output sources. Integrated electronic power supply, dimmable or non-dimmable options, depending on the version. Compliant with standard EN60598-1 and other specific standards.

## PRODUCT CODE: M250841

## FEATURES

- Article Code: **M250841**
- Colour: **Black/Green**
- Material: **Aluminium**
- Series: **Architectural Indoor**
- design by: **S./R. Cornelissen**

## DIMENSIONS

- Height: **cm 23**
- Diameter: **cm 97**
- Weight: **kg 21**
- Glow Wire Test: **960°**

## SOURCES INCLUDED

- Category: **Led Retrofit**
- Number: **1**
- Watt: **11W**
- Color temperature (K): **3000K**
- CRI: **80**
- Color Tolerance: **MacAdam 3SDCM**
- Service Life: **L70 (6K) 50000h**

- Category: **Led**
- Number: **1**
- Watt: **84W**
- Color temperature (K): **3000K**
- CRI: **80**
- Color Tolerance: **MacAdam 3SDCM**
- Service Life: **L70 (6K) 50000h**