

Track 230V Recessed three-circuit track 4000mm White

Carlotta de Bevilacqua

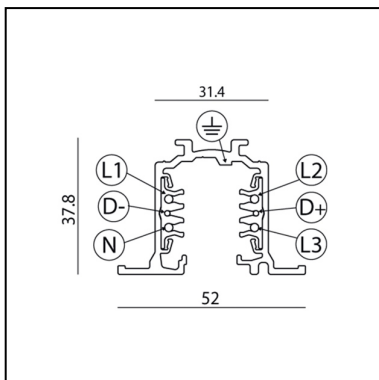
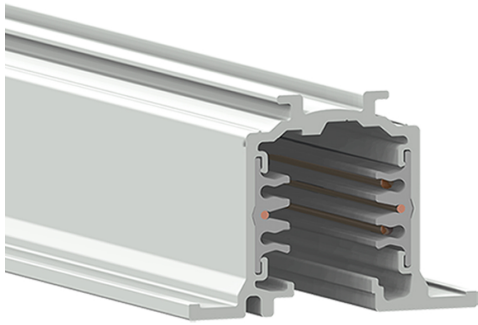

DESCRIPTION

The system is a 3 phase mixed system with two additional conductors intended to manage a general data signal (for example dali, dmx, lon, eib, etc.). The system is EN 60570 certified and its installation must be accomplished by highly qualified person. There are four possible installation systems: directly on ceiling or on wall, using the needlepoints on the track, on ceiling or on wall using a metal clip, hanging by the suspension or recessed without exceeding the maximum loads.

PRODUCT CODE: TK10401

FEATURES

- Article Code: **TK10401**
- Colour: **White**
- Installation: **TrackRecessed**
- Series: **Architectural Indoor**
- Environment: **Indoor**
- design by: **Carlotta de Bevilacqua**

DIMENSIONS

- Length: **cm 400**
- Width: **cm 52**
- Height: **cm 37.8**
- Cutout Width: **cm 31.4**

Accessories



Track 230V Recessed three-circuit track - End cap White TK10501



Track 230V Recessed three-circuit track - Power supply end cap Earth conductor on the left. White TK10801



Track 230V Recessed three-circuit track - Power supply end cap Earth conductor on the right. White TK10701



Track 230V Recessed three-circuit track - Recessed joint White TK10601



Track 230V External three-circuit track - Universal adapter 6 conductors. White TK20701



Track 230V External three-circuit track - Universal adapter 4 conductors. White TK20801



Accessories holder - Vector 55 AP91100



Lens for elliptical emission - Vector 55 AP91200



Soft filter - Vector 55 AP91300



Anti-dazzle louvre - Vector 55 AP91400



Adjustable dowsers - Vector 55 AP91500