

Vector Track 40 28° 3000K Undimmable Brushed silver

Carlotta de Bevilacqua



DESCRIPTION

Three sizes with three different beam angles each (spot, flood, wide flood) obtained by means of refractive or hybrid optical units. Vector 55 track DALI zoom optic (22°-32°). Junction arm integrated in the spotlight's body to keep the barycentre aligned with the track and prevent any imbalance in possible suspension versions of the track. The junction allows 360° rotation and 90° tilting for maximum emission adjustment freedom. Vector 95 available only in track version. Version with compact 4-conductor (3p+n) adapter with hidden LED driver and not-dimmable phase selector.

IP20   

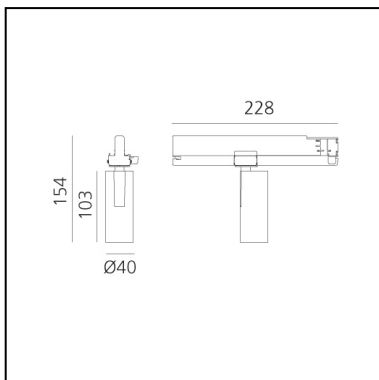

LUMINAIRE

- Watt: **10W**
- Delivered lumens output: **529lm**
- CCT: **3000K**
- Efficiency: **63%**
- Efficacy: **52.88lm/W**
- CRI: **90**

Notes

220/240Vac 50/60Hz Electronic ballast included.

PRODUCT CODE: AN00315

FEATURES

- Article Code: **AN00315**
- Colour: **Brushed Silver**
- Installation: **ProjectorTrack**
- Series: **Architectural Indoor**
- Environment: **Indoor**
- design by: **Carlotta de Bevilacqua**

DIMENSIONS

- Height: **cm 15.4**
- Diameter: **cm 4**
- Base Length: **cm 22.8**
- Inclination: **-90+90**
- Rotation: **360°**

SOURCES INCLUDED

- Category: **Led**
- Number: **1**
- Watt: **10W**
- Color temperature (K): **3000K**
- CRI: **90**
- Color Tolerance: **MacAdam 3SDCM**
- Service Life: **L90 (10K) 60500h**

Accessories



Accessories holder - Vector 40 AP90100



Lens for elliptical emission - Vector 40 AP90200



Soft filter - Vector 40 AP90300



Anti-dazzle louvre - Vector 40 AP90400