

Vector Track 55 22° 2700K Undimmable Brushed copper

Carlotta de Bevilacqua

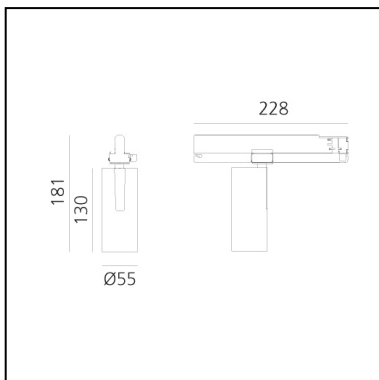

IP20   



LUMINAIRE

- Watt: **25W**
- Delivered lumens output: **1408lm**
- CCT: **2700K**
- Efficiency: **62%**
- Efficacy: **56.32lm/W**
- CRI: **90**

Notes

220/240Vac 50/60Hz Electronic ballast included.

DESCRIPTION

Three sizes with three different beam angles each (spot, flood, wide flood) obtained by means of refractive or hybrid optical units. Vector 55 track DALI zoom optic (22°-32°). Junction arm integrated in the spotlight's body to keep the barycentre aligned with the track and prevent any imbalance in possible suspension versions of the track. The junction allows 360° rotation and 90° tilting for maximum emission adjustment freedom. Vector 95 available only in track version. Version with compact 4-conductor (3p+n) adapter with hidden LED driver and not-dimmable phase selector.

PRODUCT CODE: AN11218

FEATURES

- Article Code: **AN11218**
- Colour: **Brushed Copper**
- Installation: **ProjectorTrack**
- Series: **Architectural Indoor**
- Environment: **Indoor**
- design by: **Carlotta de Bevilacqua**

DIMENSIONS

- Height: **cm 18.1**
- Diameter: **cm 5.5**
- Base Length: **cm 16.2**
- Inclination: **-90+90**
- Rotation: **360°**

SOURCES INCLUDED

- Category: **Led**
- Number: **1**
- Watt: **25W**
- Color temperature (K): **2700K**

Accessories



Accessories holder - Vector 55 AP91100



Lens for elliptical emission - Vector 55 AP91200



Soft filter - Vector 55 AP91300



Anti-dazzle louvre - Vector 55 AP91400



Adjustable dowsers - Vector 55 AP91500