

Alphabet of light Gople system

BIG - Bjarke Ingels Group



Artemide[®]

Alphabet of light

Authors

BIG - Bjarke Ingels Group

BIG is a Copenhagen, New York, London and Barcelona based group of architects, designers, urbanists, landscape professionals, interior and product designers, researchers and inventors. The office is currently involved in a large number of projects throughout Europe, North America, Asia and Middle East.

BIG's architecture emerges out of a careful analysis of how contemporary life constantly evolves and changes. Not least due to the influence from multicultural exchange, global economical flows and communication technologies, that all together require new ways of architectural and urban organization. They believe that in order to deal with today's challenges, architecture can profitably move into a field that has been largely unexplored. A pragmatic utopian architecture that steers clear of the petrifying pragmatism of boring boxes and the naïve utopian ideas of digital formalism. Like a form of programmatic alchemy, they create architecture by mixing conventional ingredients such as living, leisure, working, parking and shopping. By hitting the fertile overlap between pragmatic and utopia, the architects once again find the freedom to change the surface of our planet, to better fit contemporary life forms.



Jakob and Bjarke Ingels
Photo by Flemming Leitorp

Alphabet of light

BIG - Bjarke Ingels Group
2016

Alphabet of light system is a lighting language that continues to grow with new elements so it can be developed with increasing freedom throughout space. It is a basic principle that generates an open system implementing just a handful of basic modules.

Thanks to specific geometric proportions, these modules can be combined together to form endless lighting structures, from the most elemental to the most complex, both linear and curved. The BIG idea is combined with Artemide's optoelectronic expertise to give rise to an innovative construction principle that casts continuous and comfortable light.

It is a minimal presence that conceals ultra-sophisticated optoelectronic and patented mechanical innovation as well as ground-breaking control. The system can be controlled using the Artemide App to create freedom both in geometric design and in the definition of dynamic performance levels, which can be programmed or modified in real time. BIG designed also a new font, an alphabet that can be used to write and express one's thoughts, to establish an identity and to guide visitors through a space using light. Alphabet of Light collection can help give shape to a wide range of locations and public spaces, from hospitality and offices to educational and retail, as well as being perfect for private residential application.

PATENT OF
INVENTION

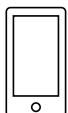

ARTEMIDE
APP



For further information on Alphabet of light
visit artemide.com













EPD Environmental product declaration



EPDITALY0430
12/05/2023
www.epditaly.it

global geographic validity
in compliance with ISO14025 and
EN50693:2019

certified codes: 2108010A, 2113010A,
2135010A 2267010APP, 2267010A,
1207000A, 1208000APP, 2154010A,
2158010A, 2250010A

+
through a dedicated LCA-TOOL all
Alphabet of light stand alone codes and
system compositions can be certified



Alphabet of light system

PATENT OF INVENTION: MECHANICAL AND ELECTRICAL CONNECTION
PATENT OF INVENTION: OPTICS





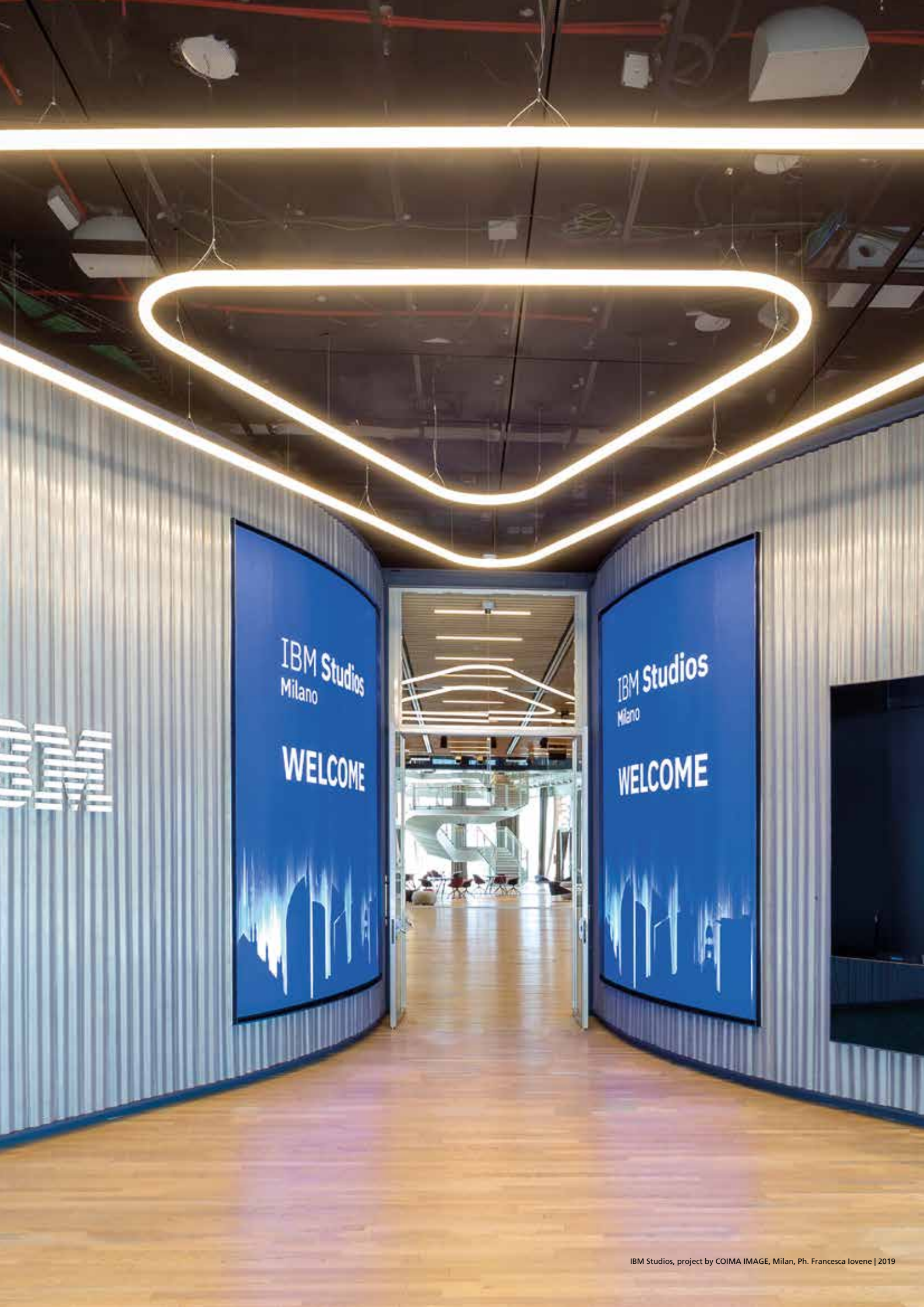

IBM Studios
Milano

WELCOME

IBM Studios
Milano

WELCOME









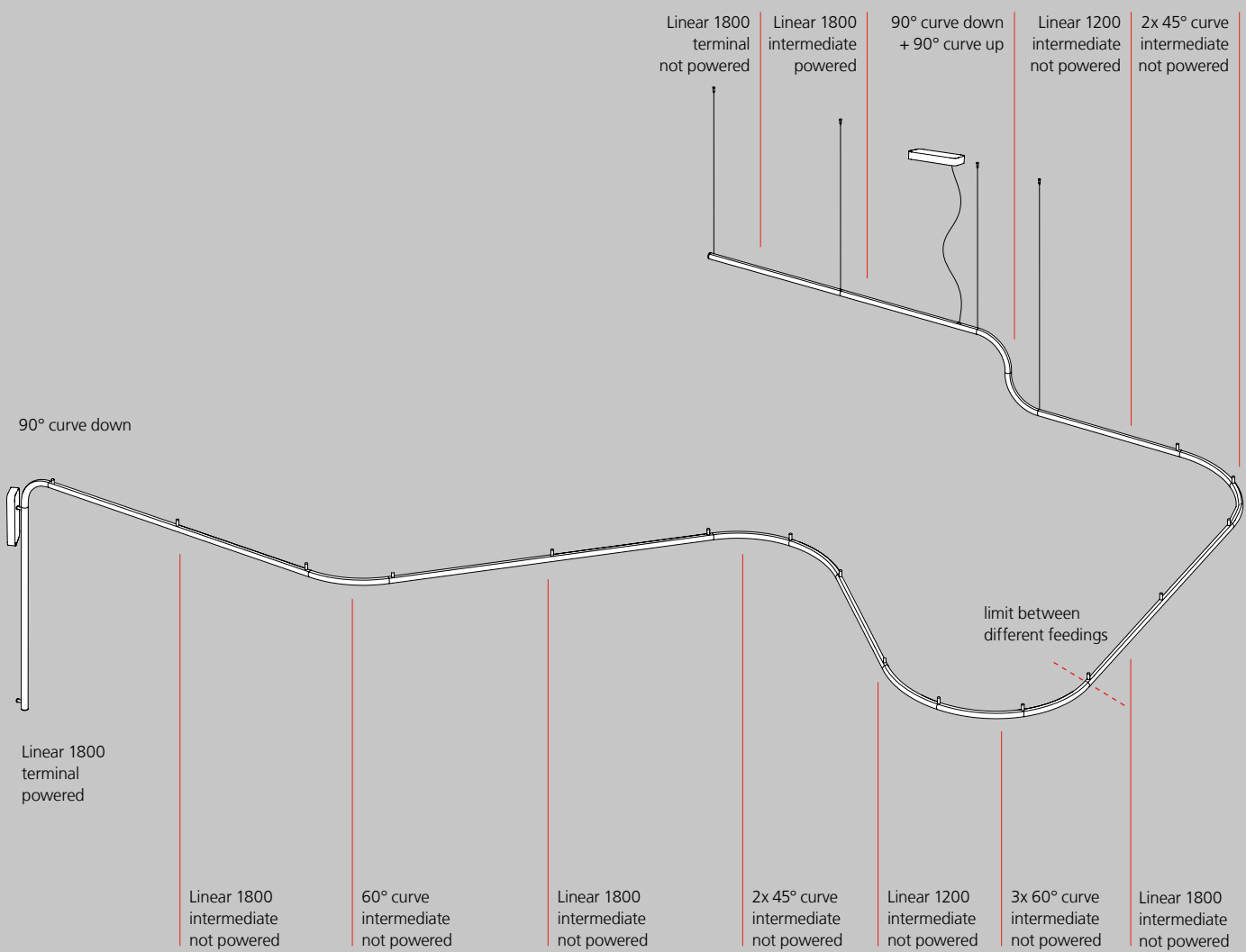

Alphabet of light system configuration

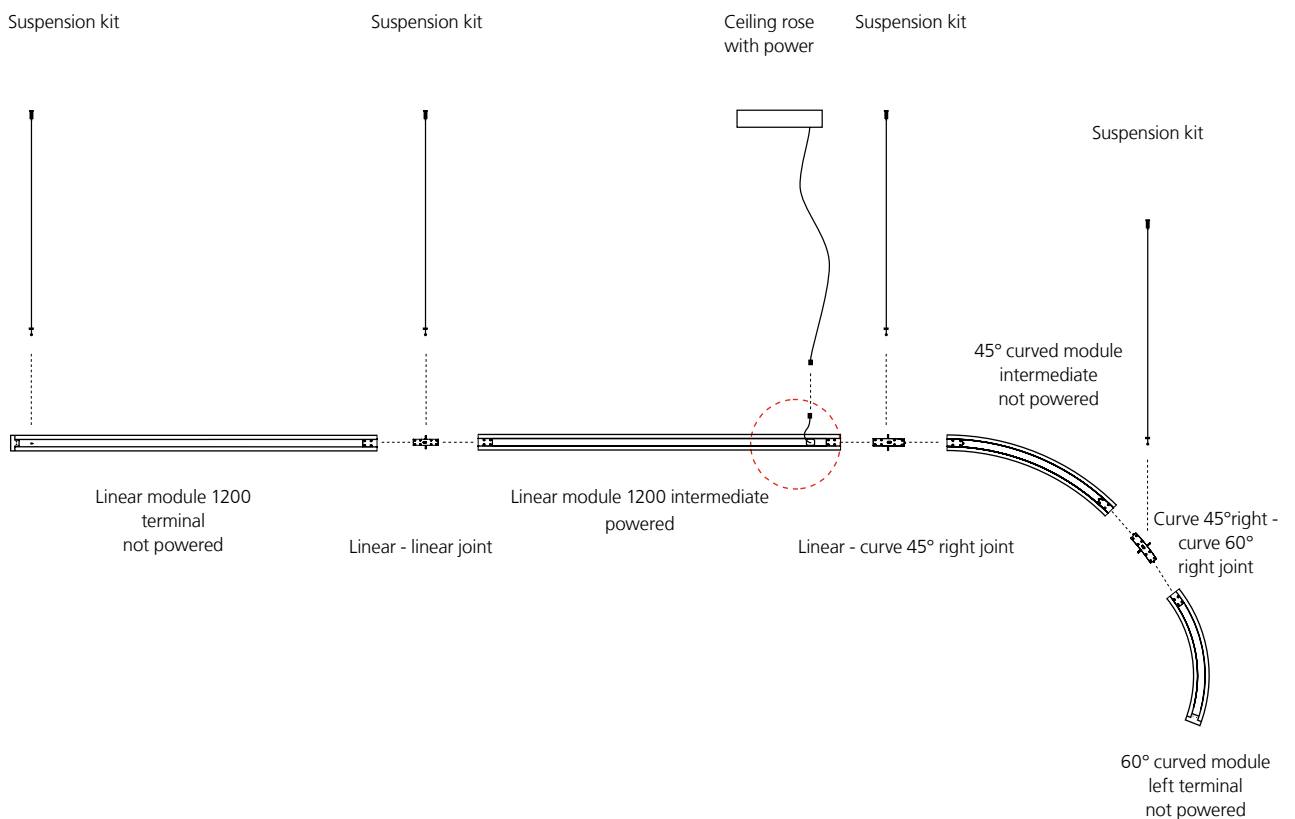

Materials: structure in anodized natural aluminum, tube in white diffusing PMMA.

Linear module are available in three lengths: L 600 / 1200 / 1800 mm

Possibility to articulate the configuration on the horizontal plane with 60°, 45° and 22,5° curves, T and X joint and on the vertical plane.

Max 10 m for each power unit (10 m in one direction or X+Y=10 m in both directions).

Dali / 1-10 / Push or APP dimmable power units, recessed or ceiling mounted.

All modules powered by same power unit will share the same dimming level.

Alphabet of light configurator

Artemide provides tools to support the end customer and especially the lighting professionals in choosing the best lighting solution.

For an intuitive composition of the most complex systems, Artemide offers innovative and complete configurators on its website.

Alphabet of light system Configurator is a useful tool to simplify the design of your composition.

After defining the layout of the space, the desired system can be created by a simple drag and drop of the various available modules. Once the project is completed, the system returns drawings and a complete datasheet with all the details to proceed with the order.

1. Build your space

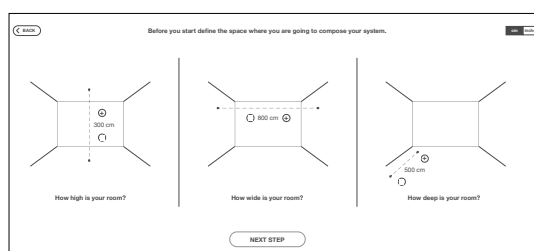

2. Drag and drop



3. Save it and send it!

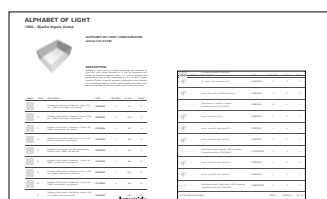



Suspension modules

LINEAR MODULES

600 terminal (588 mm)

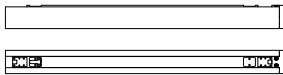

600 intermediate (588 mm)

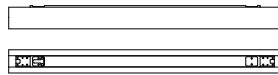

1200 terminal (1180 mm)

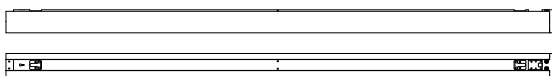

1200 intermediate (1180 mm)

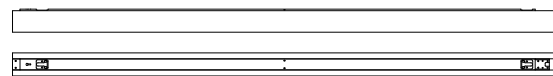

1800 terminal (1772 mm)

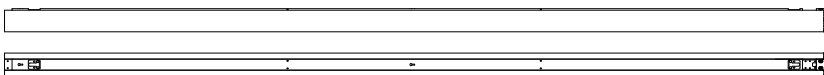

1800 intermediate (1772 mm)

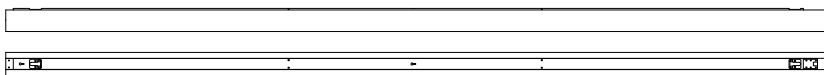

VERTICAL MODULES*

90° Vertical UP

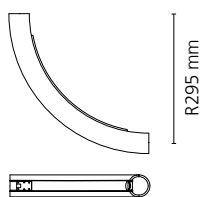

90° Vertical DOWN

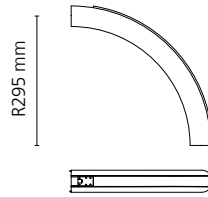

CONNECTION MODULES*

X Joint

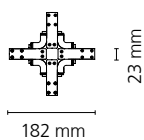

T Joint

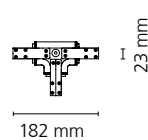

90° Joint

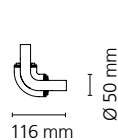

ALPHABET OF LIGHT - SYSTEM

Opal White



XF



*EDP compliance



EPDITALY0430
12/05/2023
www.epditaly.it

MacAdam 3SDCM
Life L70 (10K) 60000h
CRI =90

IP20



SUSPENSION LINEAR MODULES

Length	W	V	Flux	CCT	Powered	Not powered
					Code	Code
600 terminal	11 W	24V	1133 lm	3000K	2100010AHE	2101010AHE
				3500K	2100C10AHE	2101C10AHE
600 intermediate	11 W	24V	1133 lm	3000K		2102010AHE
				3500K		2102C10AHE
1200 terminal	21 W	24V	2267 lm	3000K	2104010AHE	2106010AHE
				3500K	2104C10AHE	2106C10AHE
1200 intermediate	21 W	24V	2267 lm	3000K	2105010AHE	2107010AHE
				3500K	2105C10AHE	2107C10AHE
1800 terminal	33 W	24V	3400 lm	3000K	2108010AHE*	2110010AHE
				3500K	2108C10AHE	2110C10AHE
1800 intermediate	33 W	24V	3400 lm	3000K	2109010AHE	2111010AHE
				3500K	2109C10AHE	2111C10AHE

VERTICAL MODULES*

Length	W	V	Flux	CCT	Not powered
					Code
90° vertical UP	8 W	24V	750 lm	3000K	2124010AHE
				3500K	2124C10AHE
90° vertical DOWN	8 W	24V	722 lm	3000K	2125010AHE
				3500K	2125C10AHE

CONNECTION MODULES*

	W	V	Flux	CCT	Not powered
					Code
X Joint	3 W	24V	253 lm	3000K	2158010AHE*
				3500K	2158C10AHE
T Joint	2,5 W	24V	211 lm	3000K	2156010AHE
				3500K	2156C10AHE
90° Joint	1,5 W	24V	105 lm	3000K	2154010AHE*
				3500K	2154C10AHE

* Vertical modules and connection modules can only be combined with linear modules.

Suspension modules

CURVED MODULES

22,5° terminal right

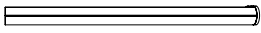

22,5° terminal left

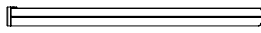

22,5° intermediate

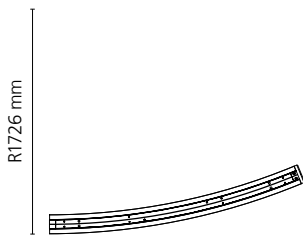

45° terminal right



45° terminal left



45° intermediate

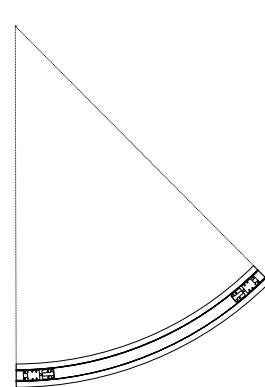
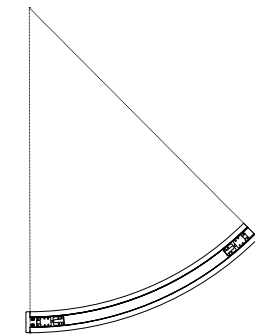
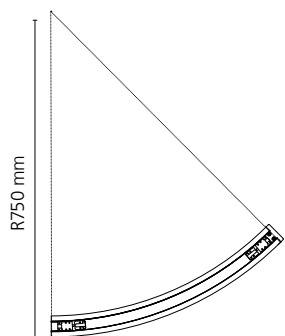

60° terminal right



60° terminal left



60° intermediate

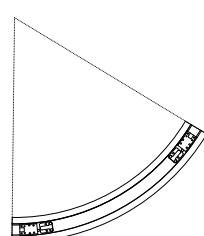
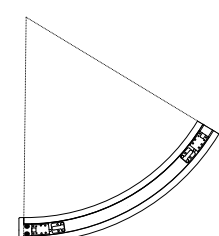
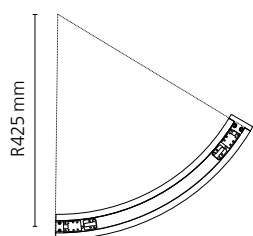

ALPHABET OF LIGHT - SYSTEM

Opal White

XF



*EDP compliance



EPDITALY0430
12/05/2023
www.epditaly.it

MacAdam 3SDCM
Life L70 (10K) 60000h
CRI =90

IP20



SUSPENSION CURVED MODULES

Length	W	V	Flux	CCT	Powered	Not powered
					Code	Code
22,5° terminal left	11 W	24V	1118 lm	3000K	2602010AHE	2605010AHE
				3500K	2602C10AHE	2605C10AHE
22,5° terminal right	11 W	24V	1118 lm	3000K	2601010AHE	2604010AHE
				3500K	2601C10AHE	2604C10AHE
22,5° intermediate	11 W	24V	1118 lm	3000K	2600010AHE	2603010AHE
				3500K	2600C10AHE	2603C10AHE
45° terminal left	11 W	24V	1118 lm	3000K	2112010AHE	2115010AHE
				3500K	2112C10AHE	2115C10AHE
45° terminal right	11 W	24V	1118 lm	3000K	2113010AHE*	2116010AHE
				3500K	2113C10AHE	2116C10AHE
45° intermediate	11 W	24V	1118 lm	3000K	2114010AHE	2117010AHE
				3500K	2114C10AHE	2117C10AHE
60° terminal left	8 W	24V	815 lm	3000K	2118010AHE	2121010AHE
				3500K	2118C10AHE	2121C10AHE
60° terminal right	8 W	24V	815 lm	3000K	2119010AHE	2122010AHE
				3500K	2119C10AHE	2122C10AHE
60° intermediate	8 W	24V	815 lm	3000K	2120010AHE	2123010AHE
				3500K	2120C10AHE	2123C10AHE

Suspension accessories

	Code
Suspension kit L=1,5 m	2266010A
Suspension kit L=4 m	2273010A
*extension feeding cable L=1,25 m	2274010A
*extension feeding cable L=2,5 m	2275010A

*The total maximum length of the feeding cable is 4,00 m (either for ceiling mounted or remote power units).
Overpassing this value could affect uniformity of light emission.

Suspension Power Units

	Code
Dali / Push ceiling power unit (175W, 220-240VAC, L=306, W=140, H=44)	2267010A *
APP ceiling power unit (175W, 220-240VAC, L=306, W=140, H=44)	2267010APP*
Dali / Push remote power unit box (175W, 220-240VAC, L=306, W=140, H=44)	2272010A
APP remote power unit box (175W, 220-240VAC, L=306, W=140, H=44)	2272010APP

Optional control devices - BLL wireless switch



Device for switching and controlling Artemide App products.
Max N.3 inputs for external push buttons.
Max 1 m distance.
Mains power supply required.
To be installed inside flush mounting boxes or junction boxes.

Code
DV1080APP



Ø 160

Wall/ceiling modules

LINEAR MODULES

600 terminal (588 mm)

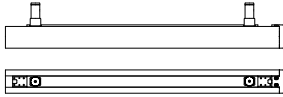

600 intermediate (588 mm)

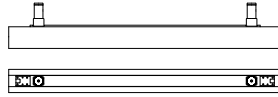

1200 terminal (1180 mm)

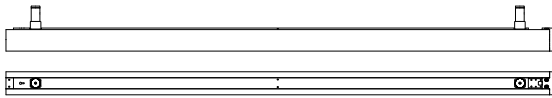

1200 intermediate (1180 mm)



1800 terminal (1772 mm)

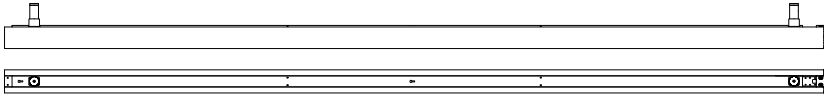

1800 intermediate (1772 mm)

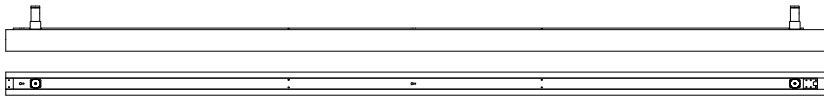

VERTICAL MODULES *

90° Vertical DOWN

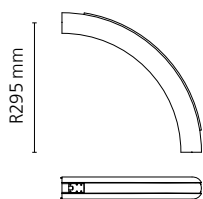

CONNECTION MODULES *

X Joint

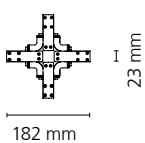

T Joint

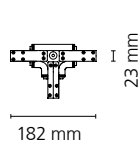

90° Joint

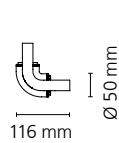

ALPHABET OF LIGHT - SYSTEM

Opal White



XF



*EDP compliance



EPDITALY0430
12/05/2023
www.epditaly.it

MacAdam 3SDCM
Life L70 (10K) 60000h
CRI =90

IP20



WALL/CEILING LINEAR MODULES

Length	W	V	Flux	CCT	Powered	Semi-recessed powered	Not powered
					Code	Code	Code
600 terminal	11 W	24V	1133 lm	3000K	2130010AHE	2160010AHE	2131010AHE
				3500K	2130C10AHE	2160C10AHE	2131C10AHE
600 intermediate	11 W	24V	1133 lm	3000K			2132010AHE
				3500K			2132C10AHE
1200 terminal	21 W	24V	2267 lm	3000K	2134010AHE	2161010AHE	2136010AHE
				3500K	2134C10AHE	2161C10AHE	2136C10AHE
1200 intermediate	21 W	24V	2267 lm	3000K	2135010AHE*	2162010AHE	2137010AHE
				3500K	2135C10AHE	2162C10AHE	2137C10AHE
1800 terminal	33 W	24V	3400 lm	3000K	2138010AHE	2163010AHE	2140010AHE
				3500K	2138C10AHE	2163C10AHE	2140C10AHE
1800 intermediate	33 W	24V	3400 lm	3000K	2139010AHE	2164010AHE	2141010AHE
				3500K	2139C10AHE	2164C10AHE	2141C10AHE

VERTICAL MODULES*

Length	W	V	Flux	CCT	Not powered
					Code
90° vertical UP	8 W	24V	750 lm	3000K	2124010AHE
				3500K	2124C10AHE
90° vertical DOWN	8 W	24V	722 lm	3000K	2125010AHE
				3500K	2125C10AHE

CONNECTION MODULES*

	W	V	Flux	CCT	Not powered
					Code
X Joint	3 W	24V	253 lm	3000K	2159010AHE
				3500K	2159C10AHE
T Joint	2,5 W	24V	211 lm	3000K	2157010AHE
				3500K	2157C10AHE
90° Joint	1,5 W	24V	105 lm	3000K	2155010AHE
				3500K	2155C10AHE

* Vertical modules and connection modules can only be combined with linear modules.

Wall/ceiling modules

CURVED MODULES

22,5° terminal right



22,5° terminal left



22,5° intermediate

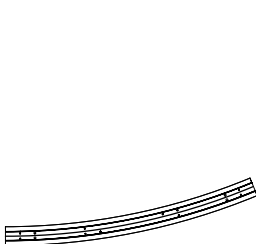
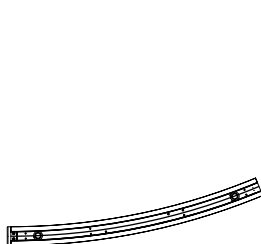
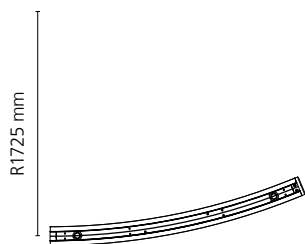

45° terminal right



45° terminal left



45° intermediate

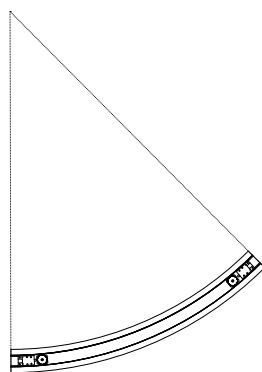
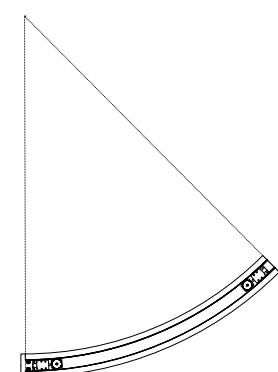
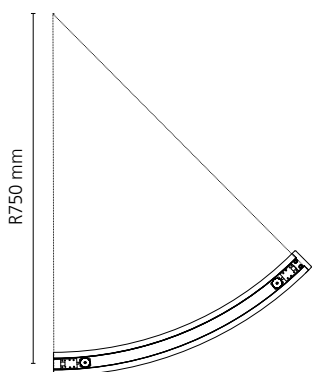

60° terminal right

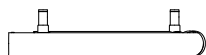

60° terminal left

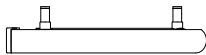

60° intermediate

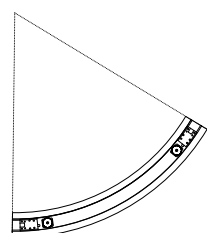
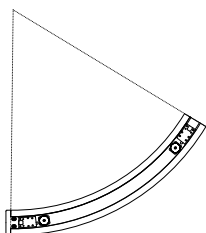
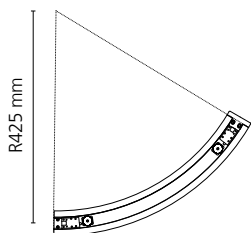

ALPHABET OF LIGHT - SYSTEM

Opal White

XF



MacAdam 3SDCM
Life L70 (10K) 60000h
CRI =90

IP20

WALL/CEILING CURVED MODULES

Length	W	V	Flux	CCT	Powered	Semi-recessed powered	Not powered
					Code	Code	Code
22,5° terminal left	11 W	24V	1118 lm	3000K	2608010AHE	2627010AHE	2611010AHE
				3500K	2608C10AHE	2627C10AHE	2611C10AHE
22,5° terminal right	11 W	24V	1118 lm	3000K	2607010AHE	2626010AHE	2610010AHE
				3500K	2607C10AHE	2626C10AHE	2610C10AHE
22,5° intermediate	11 W	24V	1118 lm	3000K	2606010AHE	2625010AHE	2609010AHE
				3500K	2606C10AHE	2625C10AHE	2609C10AHE
45° terminal left	11 W	24V	1118 lm	3000K	2142010AHE	2165010AHE	2145010AHE
				3500K	2142C10AHE	2165C10AHE	2145C10AHE
45° terminal right	11 W	24V	1118 lm	3000K	2143010AHE	2166010AHE	2146010AHE
				3500K	2143C10AHE	2166C10AHE	2146C10AHE
45° intermediate	11 W	24V	1118 lm	3000K	2144010AHE	2167010AHE	2147010AHE
				3500K	2144C10AHE	2167C10AHE	2147C10AHE
60° terminal left	8 W	24V	815 lm	3000K	2148010AHE	2168010AHE	2151010AHE
				3500K	2148C10AHE	2168C10AHE	2151C10AHE
60° terminal right	8 W	24V	815 lm	3000K	2149010AHE	2169010AHE	2152010AHE
				3500K	2149C10AHE	2169C10AHE	2152C10AHE
60° intermediate	8 W	24V	815 lm	3000K	2150010AHE	2170010AHE	2153010AHE
				3500K	2150C10AHE	2170C10AHE	2153C10AHE

Wall/Ceiling Power Units

Dali / Push ceiling power unit (175W, 220-240VAC, L=306, W=140, H=44)
 APP ceiling power unit (175W, 220-240VAC, L=306, W=140, H=44)
 Dali / Push remote power unit box (175W, 220-240VAC, L=306, W=140, H=44)
 APP remote power unit box (175W, 220-240VAC, L=306, W=140, H=44)

Code

2268010A
2268010APP
2271010A
2271010APP



Ø 160

Optional control devices - BLL wireless switch



Device for switching and controlling Artemide App products.
 Max N.3 inputs for external push buttons.
 Max 1 m distance.
 Mains power supply required.
 To be installed inside flush mounting boxes or junction boxes.

Code

DV1080APP

Joints



ALPHABET OF LIGHT - SYSTEM

Opal White



XF



*EDP compliance



EPDITALY0430
12/05/2023
www.epditaly.it

IP20



JOINTS

Accessories		
Joint		Code
01	→ Linear - linear joint ← Linear - linear joint	2250010A*
02	→ Linear - curve 45° right joint ← Curve 45° left - linear joint	2251010A
03	→ Linear - curve 45° left joint ← Curve 45° right - linear joint	2252010A
04a	→ 45° curve right - 45° curve right joint ← 45° curve left - 45° curve left joint	2255010A
04b	→ 45° curve left - 45° curve left joint ← 45° curve right - 45° curve right joint	
05	→ Linear - curve 60° right joint ← 60° curve left - linear joint	2253010A
06	→ Linear - curve 60° left joint ← 60° curve right - linear joint	2254010A
07a	→ 60° curve right - 60° curve right joint ← 60° curve left - 60° curve left joint	2256010A
07b	→ 60° curve left - 60° curve left joint ← 60° curve right - 60° curve right joint	
08	→ 60° curve right - 45° curve left joint ← 45° curve right - 60° curve left joint	2257010A
09	→ 45° curve left - 45° curve right joint ← 45° curve left - 45° curve right joint	2260010A
10	→ 60° curve right - 60° curve left joint ← 60° curve right - 60° curve left joint	2259010A
11	→ 60° curve right - 45° curve right joint ← 45° curve left - 60° curve left joint	2261010A
12	→ 60° curve left - 45° curve left joint ← 45° curve right - 60° curve right joint	2262010A
13	→ 90° down - 90° up joint ← 90° up - 90° down joint	2263010A
14	→ Linear - 90° vertical up joint ← 90° vertical up joint - linear joint	2264010A
15	→ Linear - 90° vertical down joint ← 90° vertical down - linear joint	2265010A
16	→ 60° curve left - 45° curve right joint ← 45° curve left - 60° curve right joint	2258010A
17	→ 45° curve right - 45° curve left joint ← 45° curve right - 45° curve left joint	2269010A
18	→ 60° curve left - 60° curve right joint ← 60° curve right - 60° curve left joint	2270010A
19	→ 22° curve right - 22° curve right joint ← 22° curve left - 22° curve left joint	2612010A
20	→ Linear - curve 22° right joint ← Curve 22° left - linear joint	2613010A
21	→ Linear - curve 22° left joint ← Curve 22° right - linear joint	2614010A
22	→ 22° curve right - 22° curve left joint ← 22° curve right - 22° curve left joint	2615010A
23	→ 22° curve right - 60° curve right joint ← 60° curve left - 22° curve left joint	2616010A
24	→ 22° curve right - 60° curve left joint ← 60° curve right - 22° curve left joint	2617010A
25	→ 22° curve right - 45° curve right joint ← 45° curve left - 22° curve left joint	2618010A
26	→ 22° curve right - 45° curve left joint ← 45° curve right - 22° curve left joint	2619010A
27	→ 22° curve left - 60° curve right joint ← 60° curve left - 22° curve right joint	2620010A
28	→ 22° curve left - 60° curve left joint ← 60° curve right - 22° curve right joint	2621010A
29	→ 22° curve left - 45° curve right joint ← 45° curve left - 22° curve right joint	2622010A
30	→ 22° curve left - 45° curve left joint ← 45° curve right - 22° curve right joint	2623010A
31	→ 22° curve left - 22° curve right joint ← 22° curve left - 22° curve right joint	2624010A

→ left to right path

← right to left path

→ left to right path
 ← right to left path

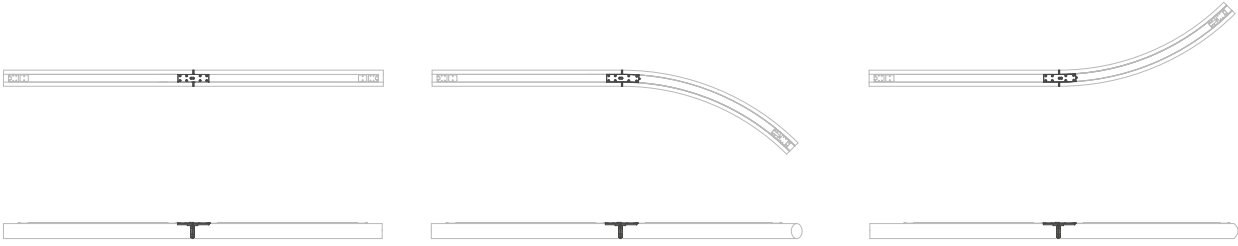

Code 2250010A_JOINT 01
 → LINEAR - LINEAR JOINT
 ← LINEAR - LINEAR JOINT

Code 2251010A_JOINT 02
 → LINEAR - CURVE 45° RIGHT JOINT
 ← CURVE 45° LEFT - LINEAR JOINT

Code 2252010A_JOINT 03
 → LINEAR - CURVE 45° LEFT JOINT
 ← CURVE 45° RIGHT - LINEAR JOINT

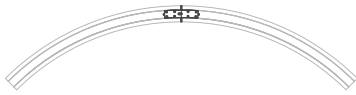

Code 2255010A_JOINT 04a
 → 45° CURVE RIGHT - 45° CURVE RIGHT JOINT
 ← 45° CURVE LEFT - 45° CURVE LEFT JOINT

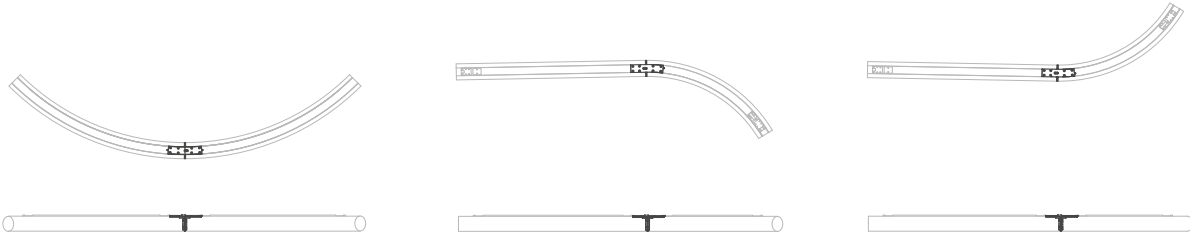

Code 2255010A_JOINT 04b
 → 45° CURVE LEFT - 45° CURVE LEFT JOINT
 ← 45° CURVE RIGHT - 45° CURVE RIGHT JOINT

Code 2253010A_JOINT 05
 → LINEAR - CURVE 60° RIGHT JOINT
 ← 60° CURVE LEFT - LINEAR JOINT RIGHT

Code 2254010A_JOINT 06
 → LINEAR - CURVE 60° LEFT JOINT
 ← 60° CURVE RIGHT - LINEAR JOINT



Code 2256010A_JOINT 07a
 → 60° CURVE RIGHT - 60° CURVE RIGHT JOINT
 ← 60° CURVE LEFT - 60° CURVE LEFT JOINT

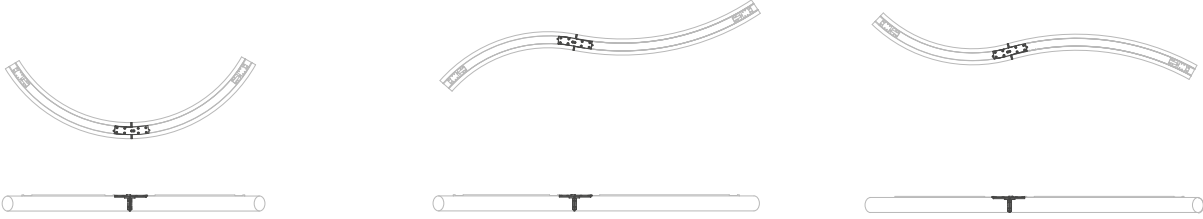

Code 2256010A_JOINT 07b
 → 60° CURVE LEFT - 60° CURVE LEFT JOINT
 ← 60° CURVE RIGHT - 60° CURVE RIGHT JOINT

Code 2257010A_JOINT 08
 → 60° CURVE RIGHT - 45° CURVE LEFT JOINT
 ← 45° CURVE RIGHT - 60° CURVE LEFT JOINT

Code 2258010A_JOINT 16
 → 60° CURVE LEFT - 45° CURVE RIGHT JOINT
 ← 45° CURVE LEFT - 60° CURVE RIGHT JOINT

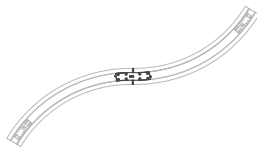

Code 2259010A_JOINT 10
 → 60° CURVE RIGHT - 60° CURVE LEFT JOINT
 ← 60° CURVE RIGHT - 60° CURVE LEFT JOINT

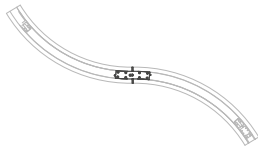

Code 2270010A_JOINT 18
 → 60° CURVE LEFT - 60° CURVE RIGHT JOINT
 ← 60° CURVE LEFT - 60° CURVE RIGHT JOINT



Code 2261010A_JOINT 11
 → 60° CURVE RIGHT - 45° CURVE RIGHT JOINT
 ← 45° CURVE LEFT - 60° CURVE LEFT JOINT



Code 2262010A_JOINT 12
 → 60° CURVE LEFT - 45° CURVE LEFT JOINT
 ← 45° CURVE RIGHT - 60° CURVE RIGHT JOINT

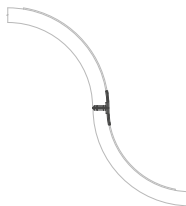

Code 2263010A_JOINT 13
 → 90° VERTICAL DOWN - 90° VERTICAL UP JOINT
 ← 90° VERTICAL UP - 90° VERTICAL DOWN JOINT



Code 2264010A_JOINT 14
 → LINEAR - 90° VERTICAL UP JOINT
 ← 90° VERTICAL UP - LINEAR JOINT



Code 2265010A_JOINT 15
 → LINEAR - 90° VERTICAL DOWN JOINT
 ← 90° VERTICAL DOWN - LINEAR JOINT

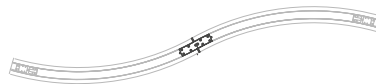

Code 2260010A_JOINT 09
 → 45° CURVE LEFT - 45° CURVE RIGHT JOINT
 ← 45° CURVE LEFT - 45° CURVE RIGHT JOINT

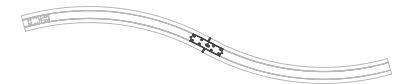

Code 2269010A_JOINT 17
 → 45° CURVE RIGHT - 45° CURVE LEFT JOINT
 ← 45° CURVE RIGHT - 45° CURVE LEFT JOINT

→ left to right path
 ← right to left path

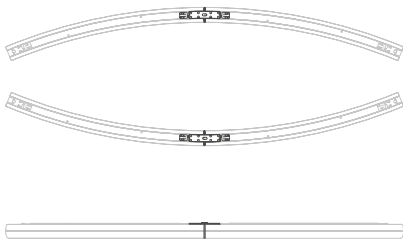

Code 2612010A_**JOINT 19**
 → 22° CURVE RIGHT - CURVE RIGHT JOINT
 ← 22° CURVE LEFT - CURVE LEFT JOINT

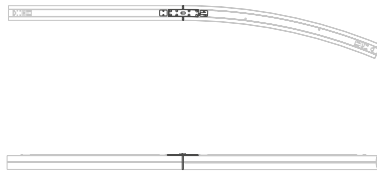

Code 2613010A_**JOINT 20**
 → LINEAR - 22° CURVE RIGHT JOINT
 ← 22° CURVE LEFT - LINEAR JOINT

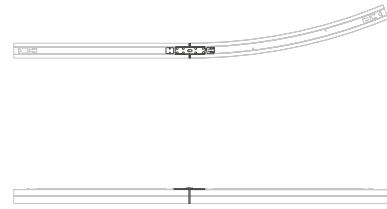

Code 2614010A_**JOINT 21**
 → LINEAR - 22° CURVE LEFT JOINT
 ← 22° CURVE RIGHT - LINEAR JOINT

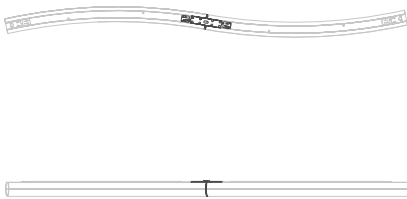

Code 2615010A_**JOINT 22**
 → 22° CURVE RIGHT - 22° CURVE LEFT JOINT
 ← 22° CURVE RIGHT - 22° CURVE LEFT JOINT

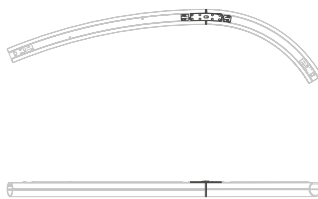

Code 2616010A_**JOINT 23**
 → 22° CURVE RIGHT - 60° CURVE RIGHT JOINT
 ← 60° CURVE LEFT - 22° CURVE LEFT JOINT

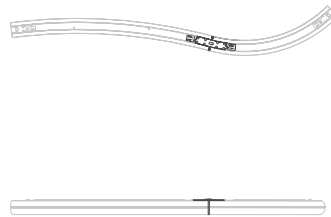

Code 2617010A_**JOINT 24**
 → 22° CURVE RIGHT - 60° CURVE LEFT JOINT
 ← 60° CURVE RIGHT - 22° CURVE LEFT JOINT

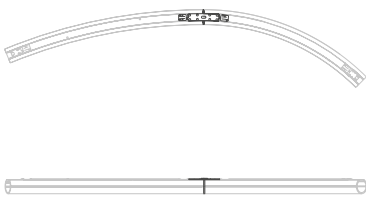

Code 2618010A_**JOINT 25**
 → 22° CURVE RIGHT - 45° CURVE RIGHT JOINT
 ← 45° CURVE LEFT - 22° CURVE LEFT JOINT

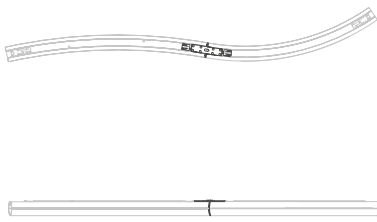

Code 2619010A_**JOINT 26**
 → 22° CURVE RIGHT - 45° CURVE LEFT JOINT
 ← 45° CURVE RIGHT - 22° CURVE LEFT JOINT

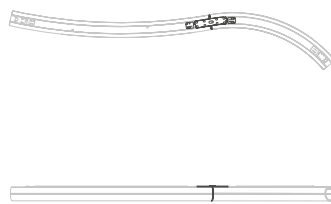

Code 2620010A_**JOINT 27**
 → 22° CURVE LEFT - 60° CURVE RIGHT JOINT
 ← 60° CURVE LEFT - 22° CURVE RIGHT JOINT

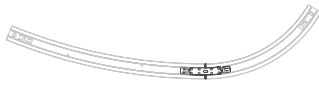

Code 2621010A_ **JOINT 28**
 → 22° CURVE LEFT - 60° CURVE LEFT JOINT
 ← 60° CURVE RIGHT - 22° CURVE RIGHT JOINT



Code 2622010A_ **JOINT 29**
 → 22° CURVE LEFT - 45° CURVE RIGHT JOINT
 ← 45° CURVE LEFT - 22° CURVE RIGHT JOINT

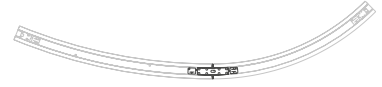

Code 2623010A_ **JOINT 30**
 → 22° CURVE LEFT - 45° CURVE LEFT JOINT
 ← 45° CURVE RIGHT - 22° CURVE RIGHT JOINT



Code 2624010A_ **JOINT 31**
 → 22° CURVE LEFT - 60° CURVE RIGHT JOINT
 ← 22° CURVE LEFT - 22° CURVE RIGHT JOINT









Gople system

BIG - Bjarke Ingles Group
2020

Gople system combines with the Alphabet of light system, creating a universal lighting able to meet the requirements of any space, but above all to define a new approach to lighting projects.

This is an increasingly universal language that diversifies its performance and expands the freedom to illuminate every angle.

Gople spot adds accent lights to break up the diffused light of Alphabet of light. Light thus follows spaces and activities not just by tracing geometries that move fluidly in three directions, but also through an alternation of light and shadow, the choice of light emissions that are diversified and specialised.

Alphabet of light is a versatile, multi-use project, perfect for illuminating any space, which in combination with Gople system opens up new fields of application and increasingly becomes the ideal tool for retail spaces.

Gople spot offers efficient performance, excellent colour rendering and numerous variables in terms of emission qualities such as colour temperature and beam angles, which make it a professional, technical product.

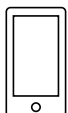

ARTEMIDE
APP



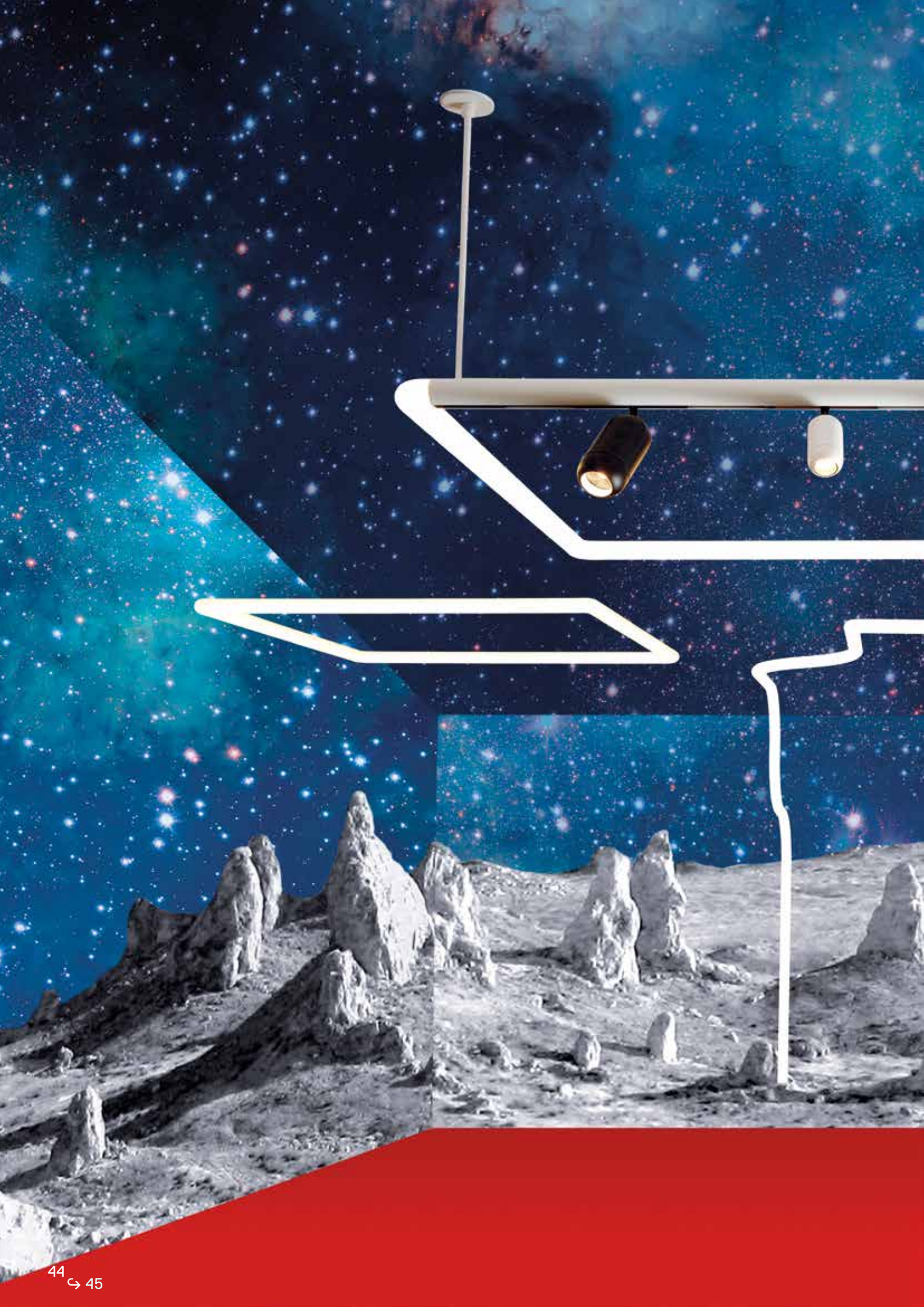



Complete system

Gople system is designed to allow double emission: it can have a track for direct spot emission and a diffused indirect light.

The different typology of Gople system modules can be combined with the maximum freedom.

The same diameter of Alphabet of light and Gople system allows to combine the two systems with mechanical continuity.



ALPHABET OF LIGHT

24V

GOPLE SYSTEM
TRACK

48V

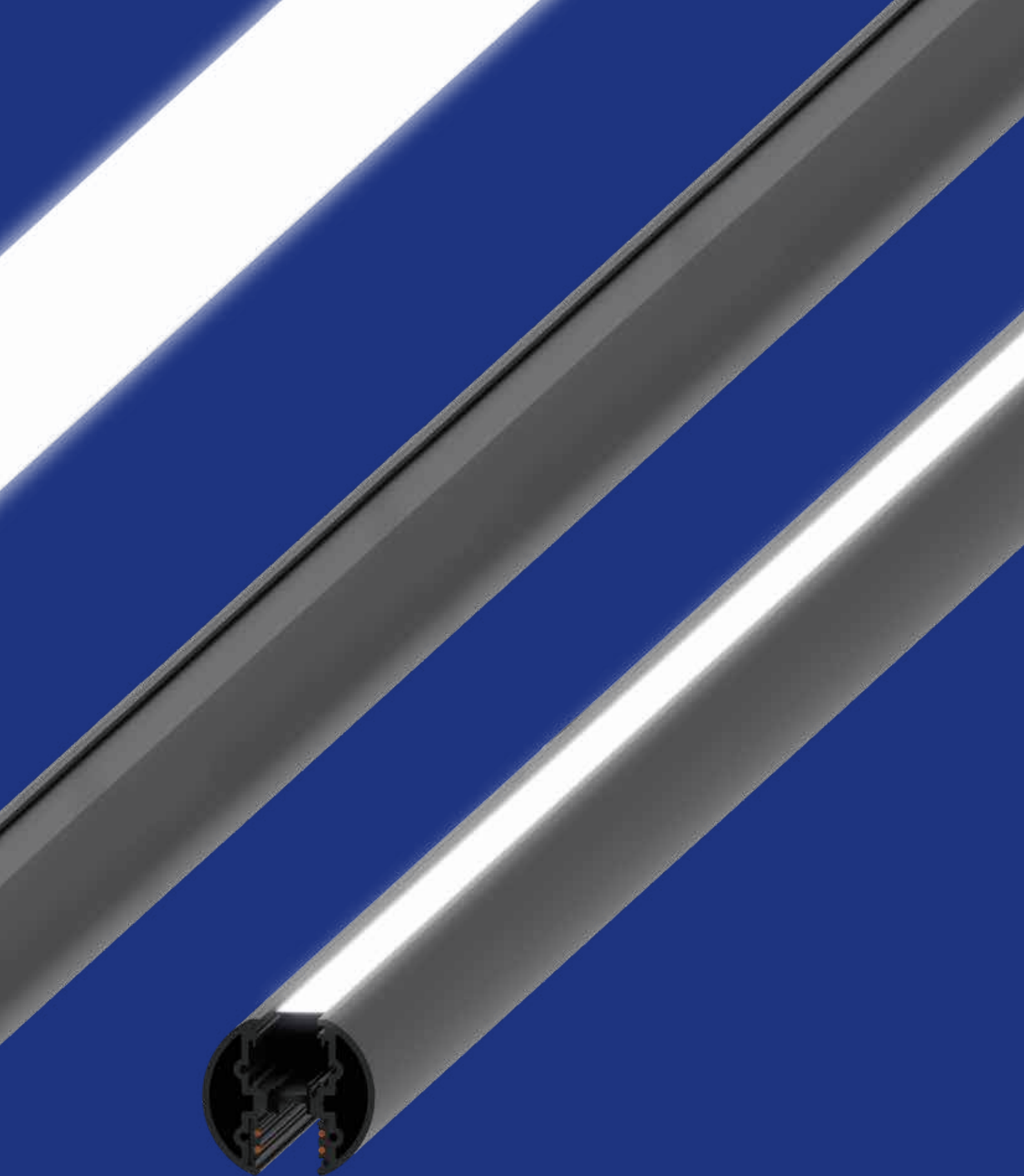

GOPLE SYSTEM
TRACK + INDIRECT EMISSION

48V

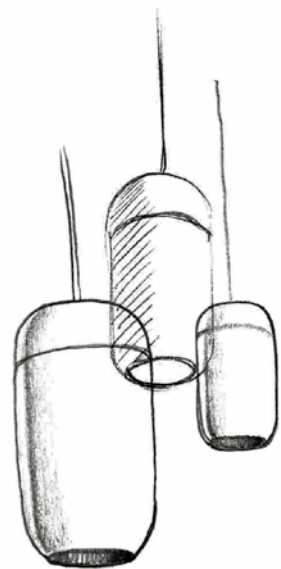
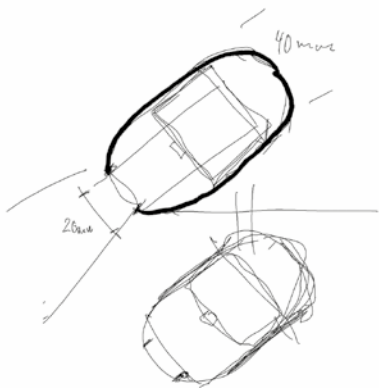
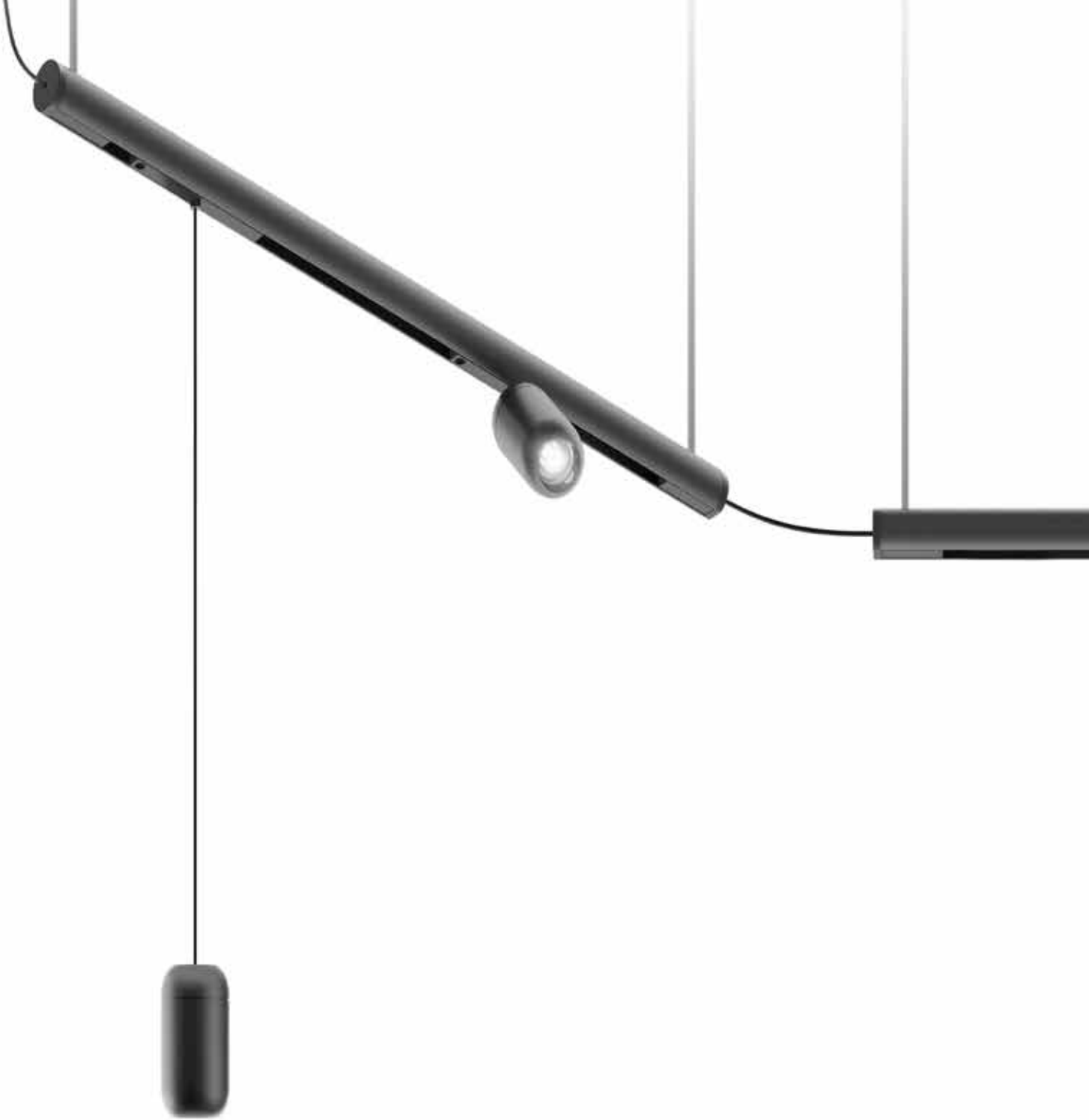



Professional performance



Gople spot offers highly professional performance within the soft geometries that remind in reduced-scale the iconic Gople diffuser. The spotlight comes in two sizes, corresponding to different power and flux levels, each with multiple beam angles.

Artemide's expertise in managing the different qualities of light is also expressed in the ability to personalise light emissions with custom solutions, selecting the parameters of colour rendering (Gamut index and Fidelity Index) and spectrum quality dedicated to specific display situations.





Gople spot



GOPLE SPOT 60



S 14° F 21° WF 28°
9W 9W 9W
557 lm* 598 lm* 542 lm*



GOPLE SPOT 80



S 15° F 22° WF 31°
23W 23W 23W
1767 lm* 1786 lm* 1854 lm*



GOPLE SPOT PENDANT 60



S 14° F 21° WF 28°
9W 9W 9W
557 lm* 598 lm* 542 lm*



GOPLE SPOT PENDANT 80



S 15° F 22° WF 31°
23W 23W 23W
1767 lm* 1786 lm* 1854 lm*

* 3000 K Values.



Gople system
Direct Spot

90° Joint **Alphabet of light**
Linear Module

Gople system
Direct Spot + Indirect Diffused

Alphabet of light
45° Curved Module

Alphabet of light
Linear Module

Gople system
Direct Spot + Indirect Diffused

Gople system
Direct Spot + Indirect Diffused

Gople system
Direct Spot + Indirect Diffused

Alphabet of light
Linear Module

Alphabet of light
Linear Module

Gople system
Direct Spot

Gople system
Direct Spot

Alphabet of light
60° Curved Module

Alphabet of light
Linear Module

Gople system
Direct Spot + Indirect Diffused

Alphabet of light
90° Vertical Module

Gople system
Direct Spot

90° Joint **Alphabet of light**
Linear Module

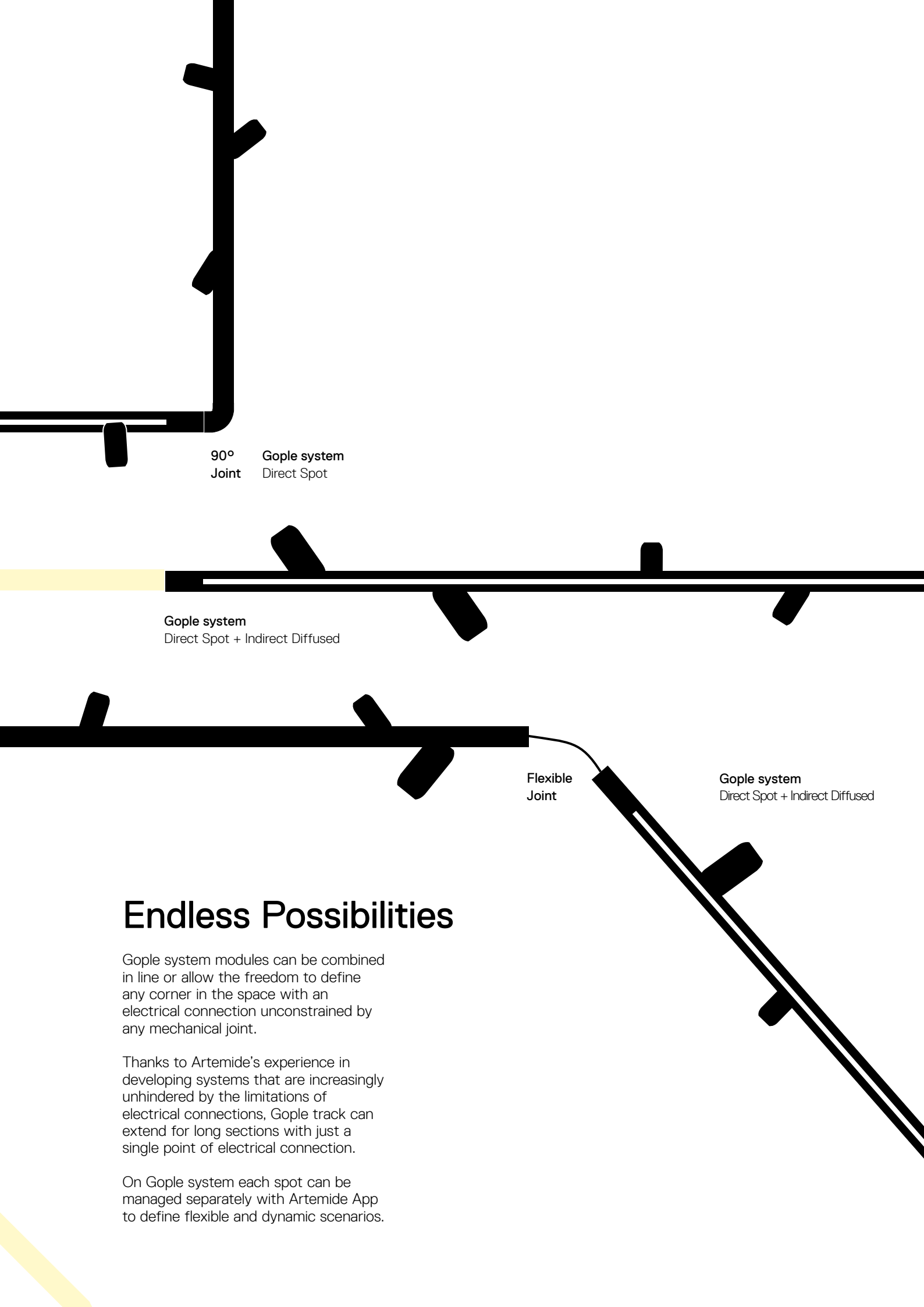

90° Joint
Gople system
Direct Spot

Gople system
Direct Spot + Indirect Diffused

Flexible Joint

Gople system
Direct Spot + Indirect Diffused

Endless Possibilities

Gople system modules can be combined in line or allow the freedom to define any corner in the space with an electrical connection unconstrained by any mechanical joint.

Thanks to Artemide's experience in developing systems that are increasingly unhindered by the limitations of electrical connections, Gople track can extend for long sections with just a single point of electrical connection.

On Gople system each spot can be managed separately with Artemide App to define flexible and dynamic scenarios.

GOPLE SYSTEM - MODULES

White Black



01



04

MacAdam 3SDCM
Life L70 (20K) 102000h
CRI =90

IP20



LINEAR MODULES

Direct Track 1180 mm

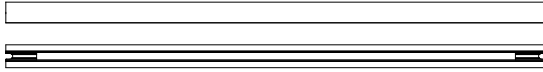

Direct Track 1772 mm

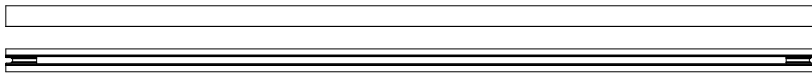

Direct Track + Indirect Emission 1180 mm

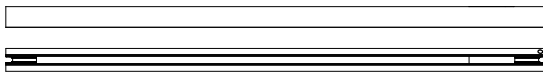

Direct Track + Indirect Emission 1772 mm

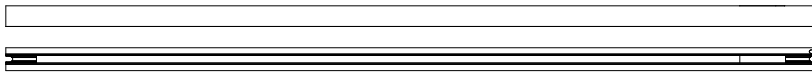

LINEAR DIRECT TRACK MODULES

Suspension/Ceiling		Code
Length	V	
1180 mm	48V	CB003. 01/04
1772 mm	48V	CB004. 01/04

LINEAR DIRECT TRACK + INDIRECT LIGHT MODULES

Suspension					Code
Length	W	V	Flux	CCT	
1180 mm	16W indirect	48V	1704 lm indirect	3000 K	CB00601
			1395 lm indirect		CB00604
1772 mm	32W indirect	48V	3204 lm indirect	3000 K	CB00701
			2622 lm indirect		CB00704



GOPLE SYSTEM - POWER SUPPLY KIT

White Black



01



04

The APP driver can not be controlled by DALI dimming system and viceversa.

IP20



CEILING

Power supply kit	ND	DALI/PUSH/0-10	Artemide App
	Code	Code	Code
<p>Ceiling Power supply kit (ND / DALI / PUSH / 0-10/ APP) 150W</p> <p>400x110x49h</p>	<p>CB500. 01/04</p>	<p>CB501. 01/04</p>	<p>CB502. 01/04</p>
<p>Ceiling Power supply kit (ND / DALI / PUSH / 0-10/ APP) 240W</p> <p>400x110x49h</p>	<p>CB503. 01/04</p>	<p>CB504. 01/04</p>	<p>CB505. 01/04</p>

RECESSED

Power supply kit	ND	DALI/PUSH/0-10	Artemide App
	Code	Code	Code
<p>Recessed Power supply kit (ND / DALI / PUSH / 0-10/ APP) 150W</p> <p>396x178x108h</p>	<p>CB60001</p>	<p>CB60101</p>	<p>CB60201</p>
<p>Recessed Power supply kit (ND / DALI / PUSH / 0-10/ APP) 240W</p> <p>396x178x108h</p>	<p>CB60301</p>	<p>CB60401</p>	<p>CB60501</p>
<p>Recessed Power supply kit (ND / DALI / PUSH / 0-10/ APP) 320W</p> <p>396x178x108h</p>	<p>CB60601</p>	<p>CB60701</p>	<p>CB60801</p>

REMOTE

Power supply kit	DALI/PUSH/0-10	Artemide App
	Code	Code
<p>Remote power supply kit (DALI / PUSH / 0-10/APP) 240W</p> <p>313x243x57,5h</p>	<p>CB70001</p>	<p>CB70101</p>
<p>Remote power supply kit (DALI / PUSH / 0-10/APP) 320W</p> <p>313x243x57,5h</p>	<p>CB70201</p>	<p>CB70301</p>

Optional control devices - BLL wireless switch

	Code
<p>Device for switching and controlling Artemide App products. Max N.3 inputs for external push buttons. Max 1 m distance. Mains power supply required. To be installed inside flush mounting boxes or junction boxes.</p>	<p>DV1080APP</p>

Gople system configuration

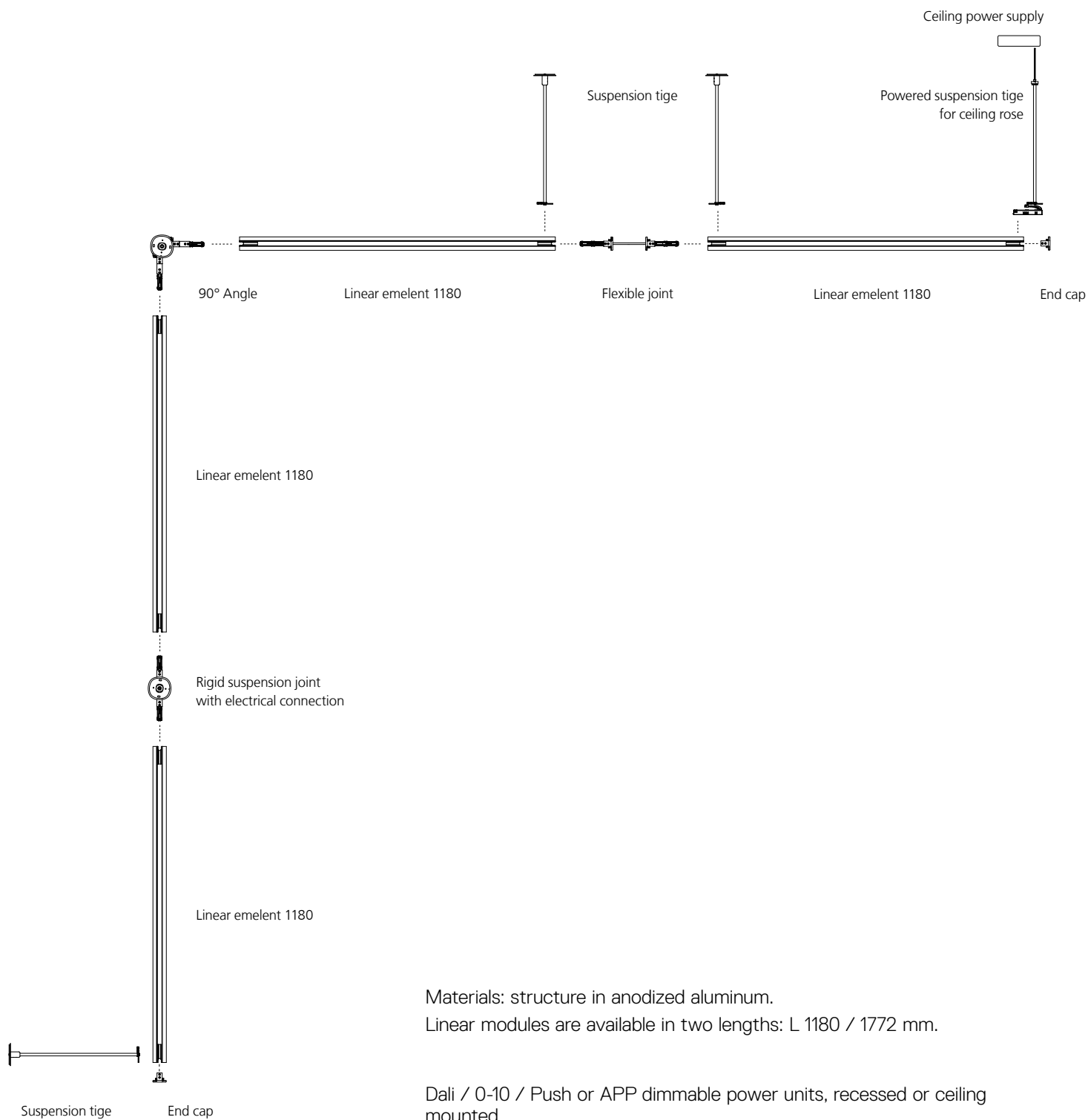

GOPLE SYSTEM - ACCESSORIES

White Black



01





04





IP20





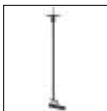

Suspension / Ceiling accessories

	Code
 <p>End cap</p>	CB300.04
 <p>Flexible joint</p>	CB207.04
 <p>Rigid suspension/ceiling joint with electrical connection</p>	CB208.01/04

Suspension accessories

	Code
 <p>Powered suspension tige for ceiling rose (L=470 mm)</p>	CB100.01/04
 <p>Powered suspension tige / ceiling mounted for recessed and remote rose (L=500 mm)</p>	CB102.01/04
 <p>Suspension/ceiling tige</p>	CB103.01/04
 <p>Powered suspension rigid joint for ceiling rose (L=470 mm)</p>	CB209.01/04
 <p>Powered suspension rigid joint for recessed and remote rose (L=500 mm)</p>	CB212.01/04

Ceiling accessories

	Code
 <p>Ceiling tige with powered head</p>	CB101.01/04
 <p>Powered ceiling tige / ceiling mounted for recessed and remote rose</p>	CB112.01/04
 <p>Suspension/ceiling tige (L=50 mm)</p>	CB103.01/04
 <p>Ceiling rigid joint with powered head</p>	CB211.01/04
 <p>Powered ceiling rigid joint for recessed and remote rose</p>	CB213.01/04

GOPLE SYSTEM - 90° ANGLE

White Black



01



04

IP20



SUSPENSION / CEILING JOINT

90° Angle with electrical connection

Code

CB400. 01/04

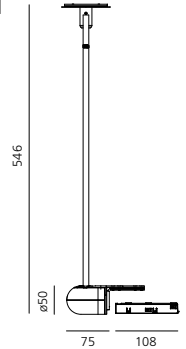
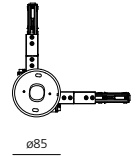

GOPLE SYSTEM + ALPHABET OF LIGHT 90° ANGLE

SUSPENSION / CEILING JOINT

90° Left Angle

(with rigid tige for suspension version and rigid tige for ceiling version)

Code

CB401. 01/04

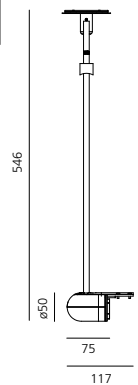
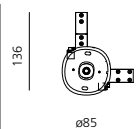

GOPLE SYSTEM + ALPHABET OF LIGHT 90° ANGLE

SUSPENSION / CEILING JOINT

90° Right Angle

(with rigid tige for suspension version and rigid tige for ceiling version)

Code

CB402. 01/04

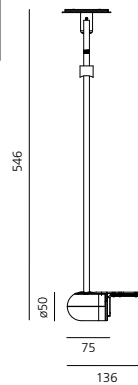
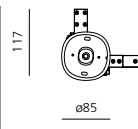



Gople spots



GOPLE SYSTEM - SPOT TRACK

White Black



01



04

SP FL WF

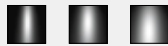

Delivery time on demand
2700K - 4000K

MacAdam 3SDCM
*MacAdam 2SDCM
CRI = 90

IP20



GOPLE 60 SPOT TRACK

W	V	Beam	Flux	CCT
9 W	48V	SP 14°	557 lm	2700K
			557 lm	3000K
			557 lm	4000K
		*FL 21°	556 lm	2700K
			598 lm	3000K
			641 lm	4000K
		*WF 28°	503 lm	2700K
			542 lm	3000K
			580 lm	4000K

Dimmable DALI

Code
CA000. 01/04
CA010. 01/04
CA020. 01/04
CA001. 01/04
CA011. 01/04
CA021. 01/04
CA002. 01/04
CA012. 01/04
CA022. 01/04

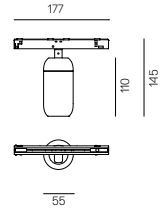

GOPLE 80 SPOT TRACK

W	V	Beam	Flux	CCT
19 W	48V	SP 17°	1739 lm	2700K
			1837 lm	3000K
			1986 lm	4000K
		FL 23°	1779 lm	2700K
			1879 lm	3000K
			2031 lm	4000K
		WF 31°	1845 lm	2700K
			1949 lm	3000K
			2107 lm	4000K

Dimmable DALI

Code
CA100. 01/04
CA110. 01/04
CA120. 01/04
CA101. 01/04
CA111. 01/04
CA121. 01/04
CA102. 01/04
CA112. 01/04
CA122. 01/04

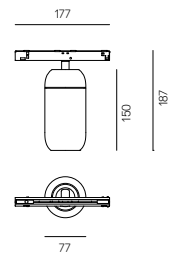

GOPLE 60 SPOT PENDANT TRACK

W	V	Beam	Flux	CCT
9 W	48V	SP 14°	557 lm	2700K
			557 lm	3000K
			557 lm	4000K
		*FL 21°	556 lm	2700K
			598 lm	3000K
			641 lm	4000K
		*WF 28°	503 lm	2700K
			542 lm	3000K
			580 lm	4000K

Dimmable DALI

Code
CA200. 01/04
CA210. 01/04
CA220. 01/04
CA201. 01/04
CA211. 01/04
CA221. 01/04
CA202. 01/04
CA212. 01/04
CA222. 01/04

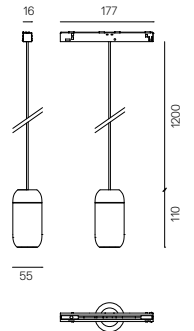

GOPLE 80 SPOT PENDANT TRACK

W	V	Beam	Flux	CCT
19 W	48V	SP 17°	1739 lm	2700K
			1837 lm	3000K
			1986 lm	4000K
		FL 23°	1779 lm	2700K
			1879 lm	3000K
			2031 lm	4000K
		WF 31°	1845 lm	2700K
			1949 lm	3000K
			2107 lm	4000K

Dimmable DALI

Code
CA300. 01/04
CA310. 01/04
CA320. 01/04
CA301. 01/04
CA311. 01/04
CA321. 01/04
CA302. 01/04
CA312. 01/04
CA322. 01/04

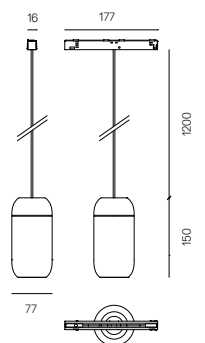

Alphabet of light & Gople system Joints



ALPHABET OF LIGHT AND GOPLE SYSTEM - JOINTS

White Black



01



04

IP20



JOINTS

		Code
01	→ Linear - linear joint	CB200. 01/04
02	→ Linear - curve 45° right joint	CB201. 01/04
03	→ Linear - curve 45° left joint	CB202. 01/04
04	→ Linear - curve 60° right joint	CB203. 01/04
05	→ Linear - curve 60° left joint	CB204. 01/04
06	→ Linear - curve up joint	CB205. 01/04
07	→ Linear - curve down joint	CB206. 01/04
08	→ Linear - curve 90° right joint	CB307. 01/04
09	→ Linear - curve 90° left joint	CB306. 01/04



Code CB200.01/04_JOINT 1
→ LINEAR - LINEAR JOINT

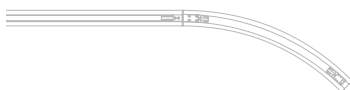

Code CB201.01/04_JOINT 2
→ LINEAR - CURVE 45° RIGHT JOINT



Code CB202.01/04_JOINT 3
→ LINEAR - CURVE 45° LEFT JOINT



Code CB203.01/04_JOINT 4
→ LINEAR - CURVE 60° RIGHT JOINT



Code CB204.01/04_JOINT 5
→ LINEAR - CURVE 60° LEFT JOINT



Code CB205.01/04_JOINT 6
→ LINEAR - CURVE UP JOINT



Code CB206.01/04_JOINT 7
→ LINEAR - CURVE DOWN JOINT



Code CB307.01/04_JOINT 8
→ LINEAR - CURVE 90° RIGHT JOINT



Code CB306.01/04_JOINT 9
→ LINEAR - CURVE 90° LEFT JOINT

Alphabet of light & Gople system configuration

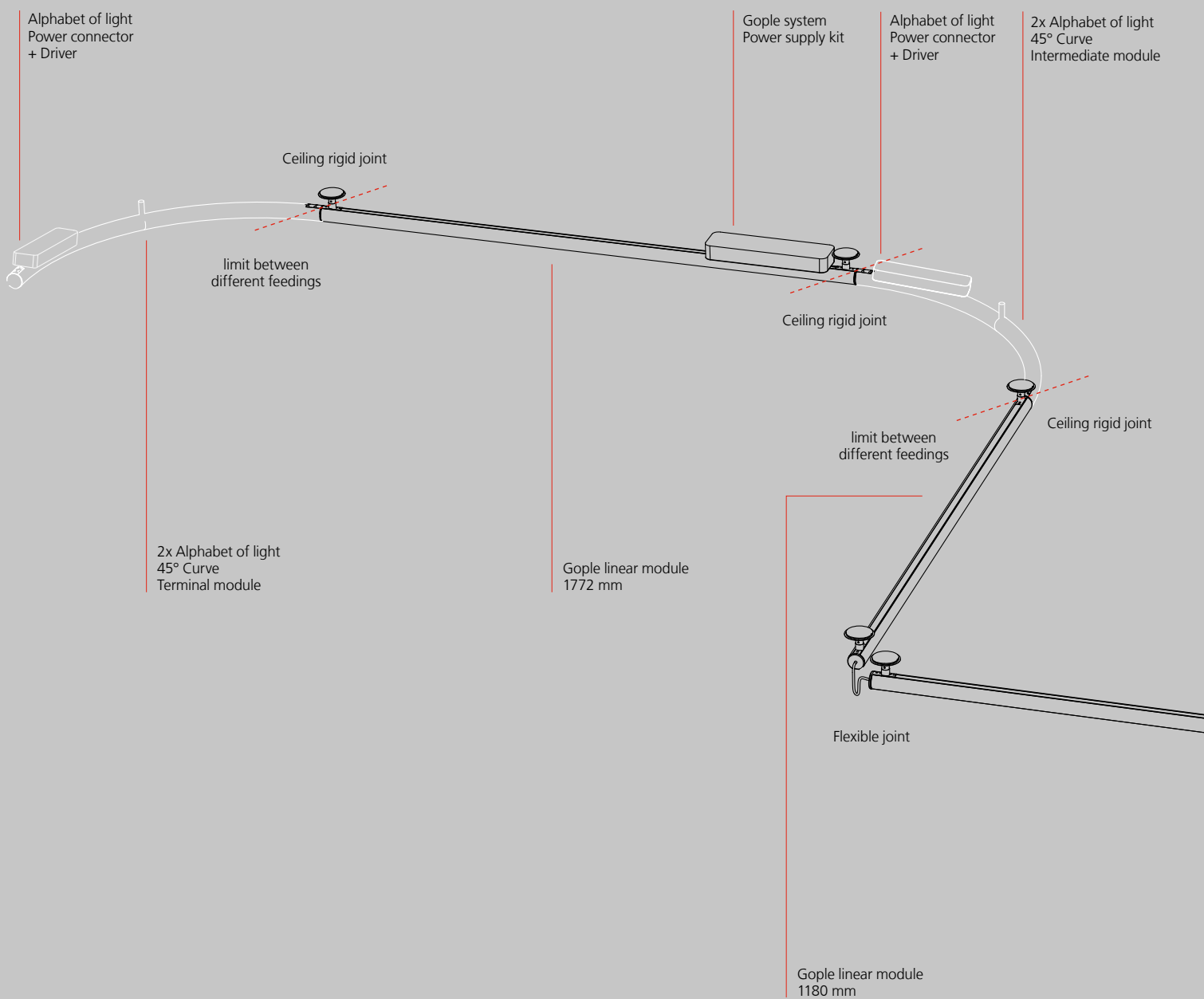

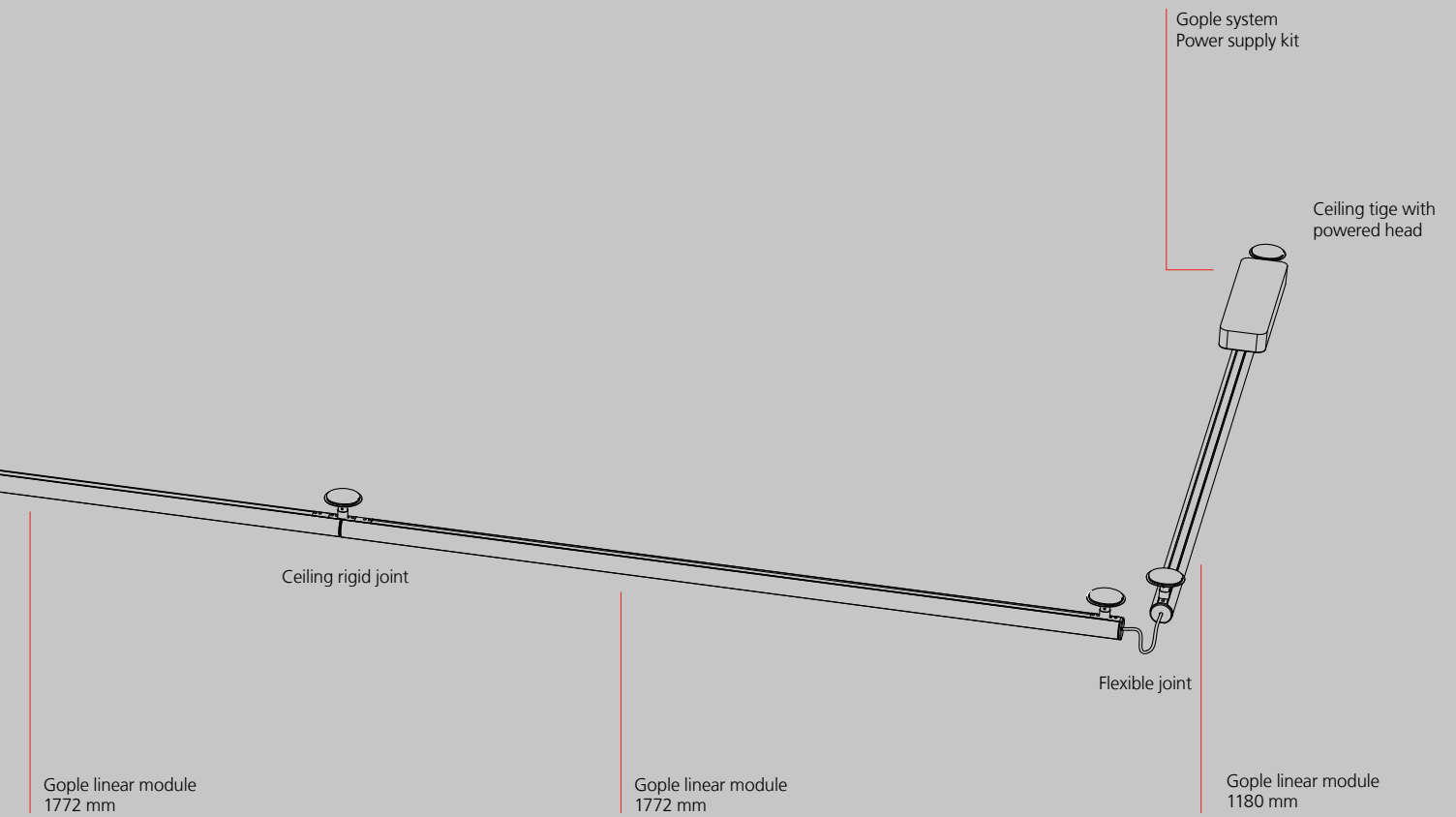
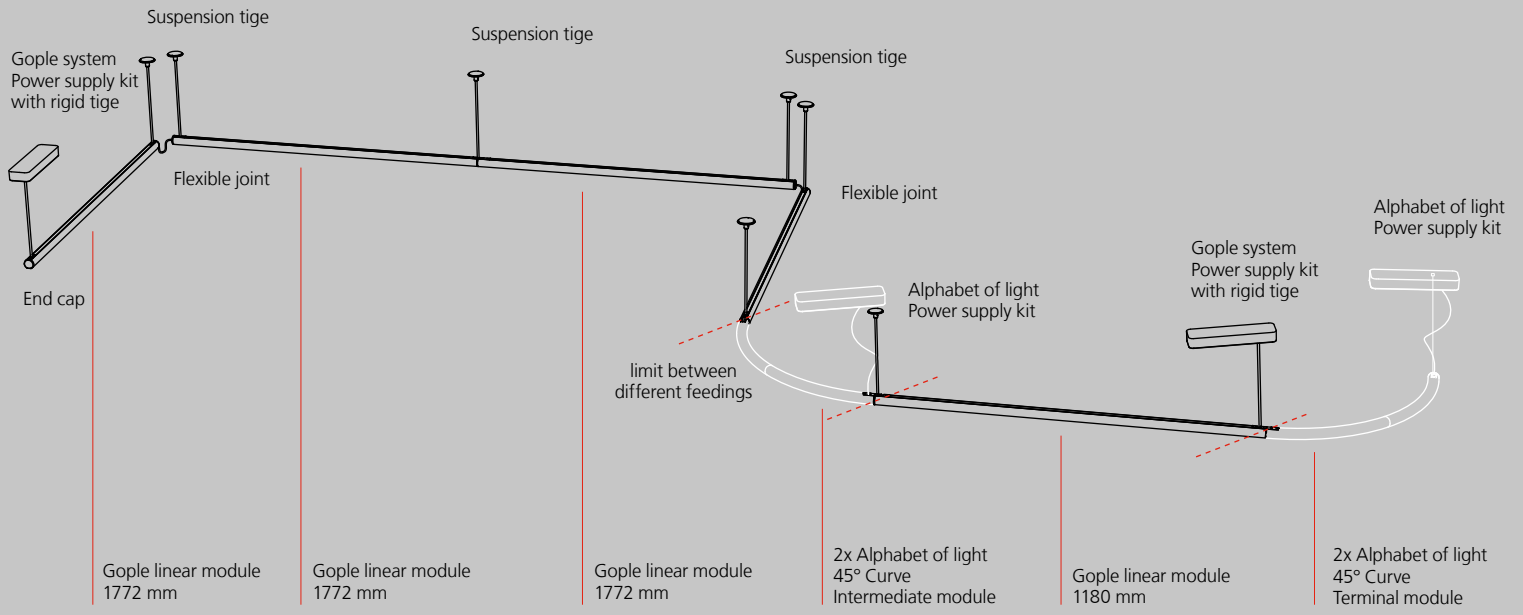







Alphabet of light stand alone

Linear

Rectangular

Square

Circular

PATENT OF INVENTION: MECHANICAL AND ELECTRICAL CONNECTION
PATENT OF INVENTION: OPTICS



ARTEMIDE
APP



Materials: structure in anodized natural aluminum,
tube in white diffusing PMMA.

Linear modules are available in lengths: 1200 / 1800 / 2400 mm.

Rectangular modules are available in size: 1911 x 1321 mm.

Square modules are available in size: 1321 / 1911 mm

Circular modules are available in diameters: \varnothing tot 900 / 1550 / 3500 mm



ALPHABET OF LIGHT - LINEAR

Opal White



XF



*EDP compliance



EPDITALY0430
12/05/2023
www.epditaly.it

MacAdam 3SDCM
Life L70 (10K) 60000h
CRI =90

IP20



WALL/CEILING

	W	Flux	CCT	DALI / PUSH Code	APP & PUSH Code
Linear 120	35 W	3480 lm	3000K	1304000A	1304000APP
Linear 180	50 W	5226 lm	3000K	1305000A	1305000APP
Linear 240	63 W	6968 lm	3000K	1308000A	1308000APP



SUSPENSION

	W	Flux	CCT	DALI / PUSH Code	APP / PUSH Code
Linear 120	26 W	3484 lm	3000K	1204000A	1204000APP
Linear 180	39 W	5226 lm	3000K	1205000A	1205000APP
Linear 240	52 W	6968 lm	3000K	1208000A	1208000APP*

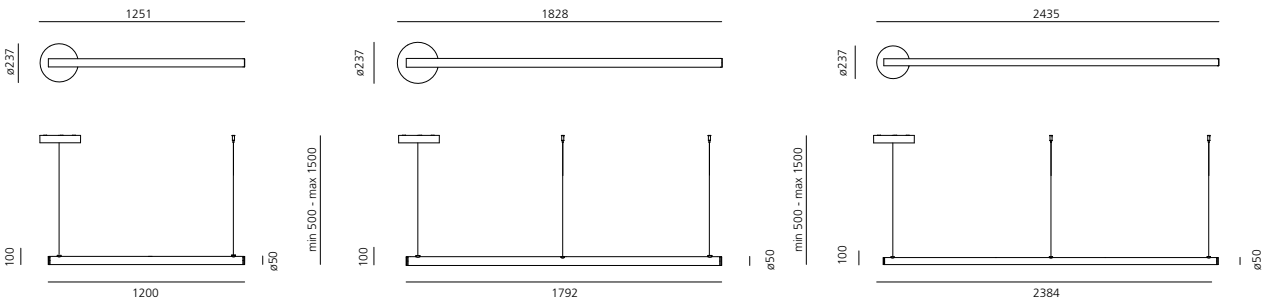
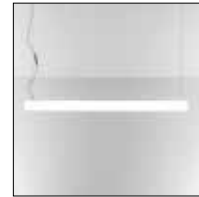

4.5 m extension feeding cable + 3 suspension wires L=6m for AoL linear 120/180/240

Code
1209000A

Optional control devices - BLL wireless switch



Device for switching and controlling Artemide App products.
Max N.3 inputs for external push buttons.
Max 1 m distance.
Mains power supply required.
To be installed inside flush mounting boxes or junction boxes.

Code
DV1080APP

ALPHABET OF LIGHT - LINEAR

Opal White 	XF 	Constant current SELV driver supplied separately	MacAdam 3SDCM Life L70 (10K) 60000h CRI =90	IP20
----------------	--------	---	---	----------

WALL/CEILING SEMI-RECESSED

	I	W	Flux	CCT	Code
Linear 120	800mA	23 W	3484 lm	3000K	1425000A
Linear 180	1050mA	35 W	5226 lm	3000K	1426000A
Linear 240	1400mA	47 W	6968 lm	3000K	1427000A

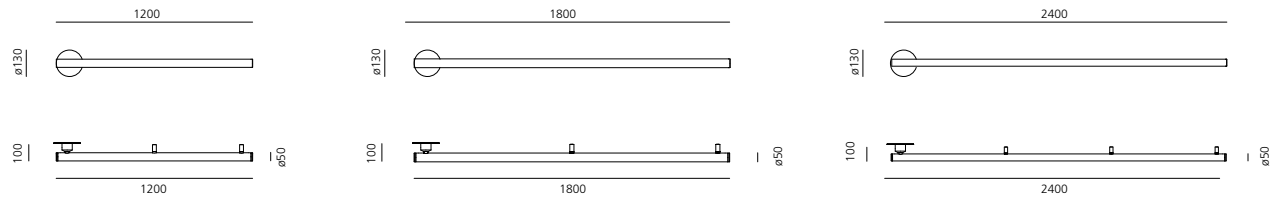

Model	Driver	Vac	Pw	L _{mm}	W _{mm}	H _{mm}		Code
Linear 120	CC 800mA	220-240	35	124	80	22	DALI / 1-10 / PUSH	DV1035
Linear 120	CC 800mA	220-240	35	124	80	22	APP / PUSH	DV1035APP
Linear 180	CC 1200mA	220-240	50	124	80	22	DALI / 1-10 / PUSH	DV1035
Linear 180	CC 1200mA	220-240	50	124	80	22	APP / PUSH	DV1035APP
Linear 240	CC 1600mA	220-240	63	130	76	30	DALI / 1-10 / PUSH	DV1034
Linear 240	CC 1600mA	220-240	63	130	76	30	APP / PUSH	DV1034APP











ALPHABET OF LIGHT - RECTANGULAR/SQUARE

Opal White	XF	MacAdam 3SDCM Life L70 (10K) 60000h CRI =90	IP20 ⊕
			

SQUARE WALL/CEILING

	W	Flux	CCT
Square 120	100 W	9488 lm	3000K
Square 180	145 W	14020 lm	3000K

DALI / PUSH
Code
1430210A
1430220A

APP & PUSH
Code
1430210APP
1430220APP

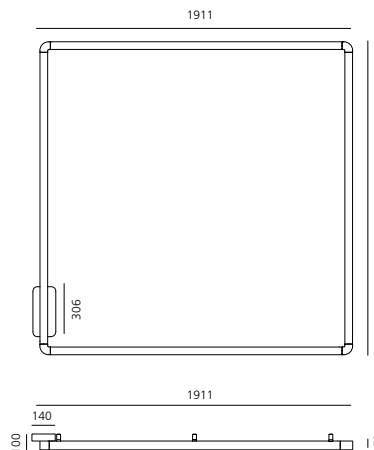
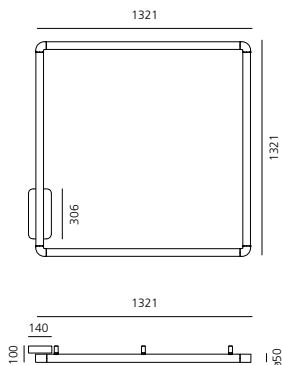
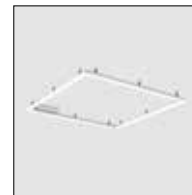

RECTANGULAR WALL/CEILING

	W	Flux	CCT
Rectangular	120 W	11754 lm	3000K
	125 W	11754 lm	3000K

DALI / PUSH
Code
1430230A

APP & PUSH
Code
1430230APP

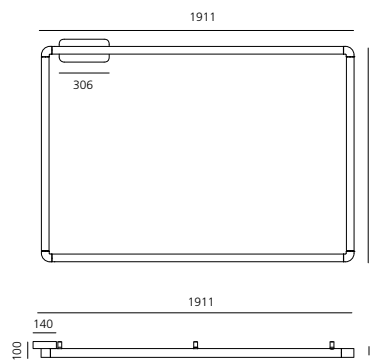
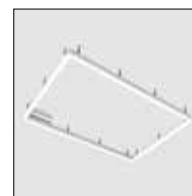



Optional control devices - BLL wireless switch



Device for switching and controlling Artemide App products.
 Max N.3 inputs for external push buttons.
 Max 1 m distance.
 Mains power supply required.
 To be installed inside flush mounting boxes or junction boxes.

Code
DV1080APP

ALPHABET OF LIGHT - RECTANGULAR/SQUARE

Opal White	XF	MacAdam 3SDCM Life L70 (10K) 60000h CRI =90	IP20
			

SQUARE SUSPENSION

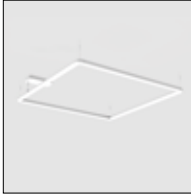
	W	Flux	CCT	DALI / PUSH	APP & PUSH	
				Code	Code	
Square 120	100 W	9488 lm	3000K	1430010A	1430010APP	
Square 180	145 W	14020 lm	3000K	1430020A	1430020APP	

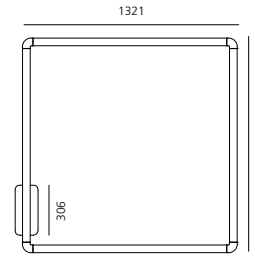

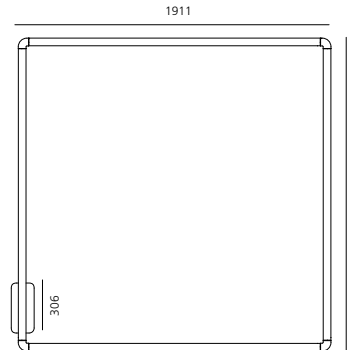

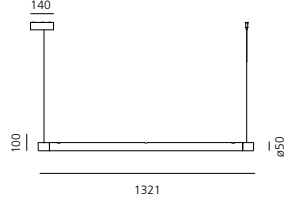

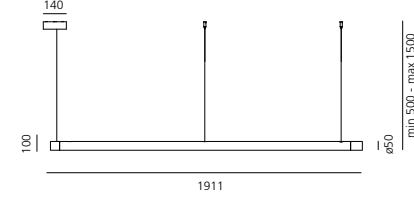

RECTANGULAR SUSPENSION

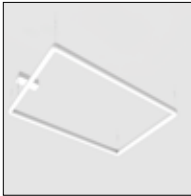
	W	Flux	CCT	DALI / PUSH	APP & PUSH	
				Code	Code	
Rectangular	120 W	11754 lm	3000K	1430030A	1430030APP	
	125 W	11754 lm	3000K			

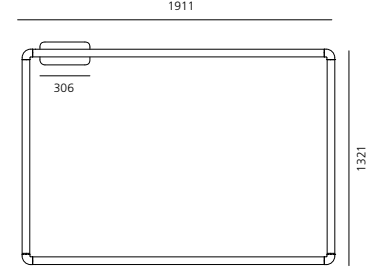

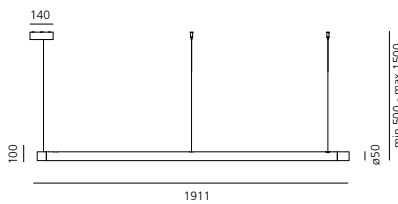

Optional control devices - BLL wireless switch



Device for switching and controlling Artemide App products.
 Max N.3 inputs for external push buttons.
 Max 1 m distance.
 Mains power supply required.
 To be installed inside flush mounting boxes or junction boxes.

Code
DV1080APP

ALPHABET OF LIGHT - RECTANGULAR/SQUARE

Opal White

XF



MacAdam 3SDCM
Life L70 (10K) 60000h
CRI =90

IP20



SQUARE WALL/CEILING SEMI-RECESSED

	W	Flux	CCT	Code
Square 120	90 W	9488 lm	3000K	1430110A
Square 180	138 W	14020 lm	3000K	1430120A

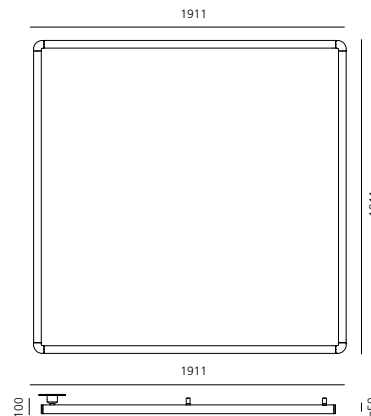
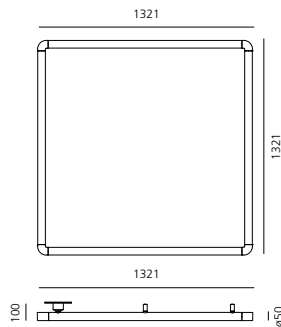
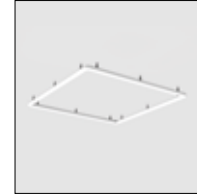

RECTANGULAR WALL/CEILING SEMI-RECESSED

	W	Flux	CCT	Code
Rectangular	114 W	11754 lm	3000K	1430130A

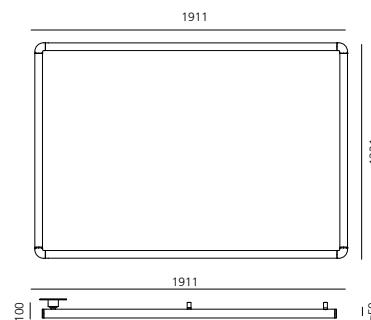
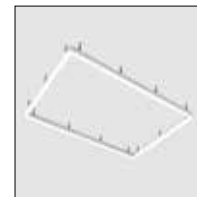

Wall/Ceiling Semi-recessed Power Units

Dali / Push remote power unit box (175W, 220-240VAC, L=306, W=140, H=44)
APP remote power unit box (175W, 220-240VAC, L=306, W=140, H=44)

Code

2271010A

2271010APP

Optional control devices - BLL wireless switch



Device for switching and controlling Artemide App products.
Max N.3 inputs for external push buttons.
Max 1 m distance.
Mains power supply required.
To be installed inside flush mounting boxes or junction boxes.

Code

DV1080APP



La Biennale di Venezia, "Robin Hood Gardens: A Ruin in Reverse" Exhibition, | 2018









ALPHABET OF LIGHT - CIRCULAR

<p>Opal White</p>	<p>XF</p>	<p>MacAdam 3SDCM Life L70 (10K) 60000h CRI =90</p>	<p>IP20</p>
-------------------	-----------	--	-------------

WALL/CEILING

	W	Flux	CCT	DALI / PUSH	APP & PUSH
				Code	Code
Circular ø 90	44 W	5783 lm	3000K	1306000A	1306000APP
Circular ø155	78 W	10280 lm	3000K	1307000A	1307000APP
Circular ø350	156 W	20953 lm	3000K	1214000A	1214000APP

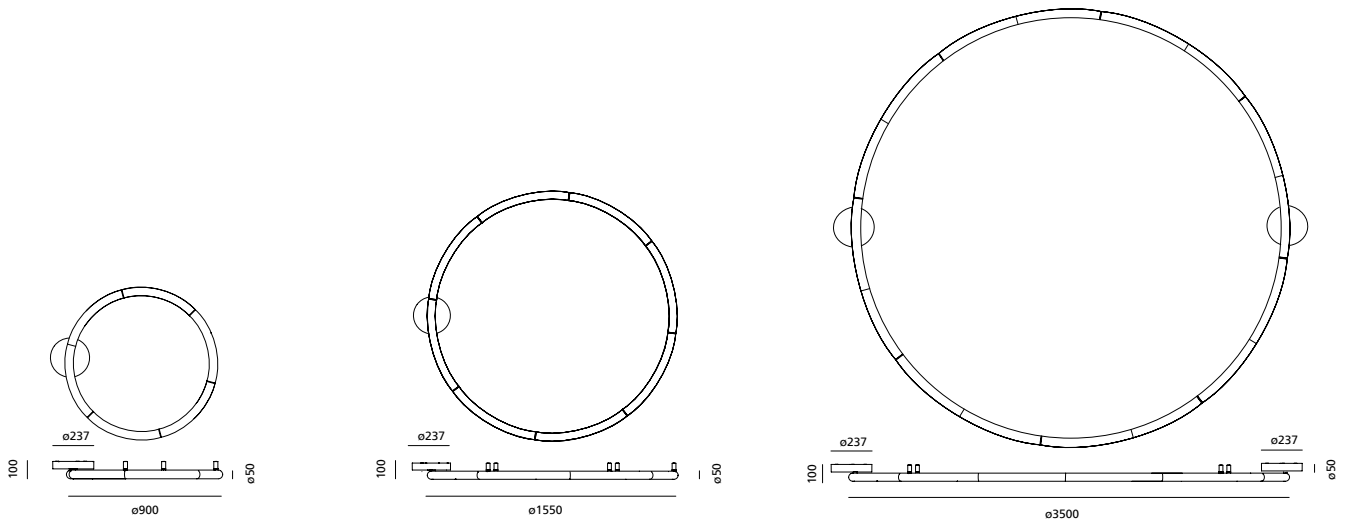

Optional control devices - BLL wireless switch



Device for switching and controlling Artemide App products.
 Max N.3 inputs for external push buttons.
 Max 1 m distance.
 Mains power supply required.
 To be installed inside flush mounting boxes or junction boxes.

Code
DV1080APP

ALPHABET OF LIGHT - CIRCULAR

Opal White	XF	Constant current SELV driver supplied separately	MacAdam 3SDCM Life L70 (10K) 60000h CRI =90	IP20

WALL/CEILING SEMI-RECESSED

	W	Flux	CCT	Code
Circular ø 90	44 W	5783 lm	3000K	1428000A
Circular ø155	78 W	10280 lm	3000K	1429000A
Circular ø350	156 W	20953 lm	3000K	1215000A

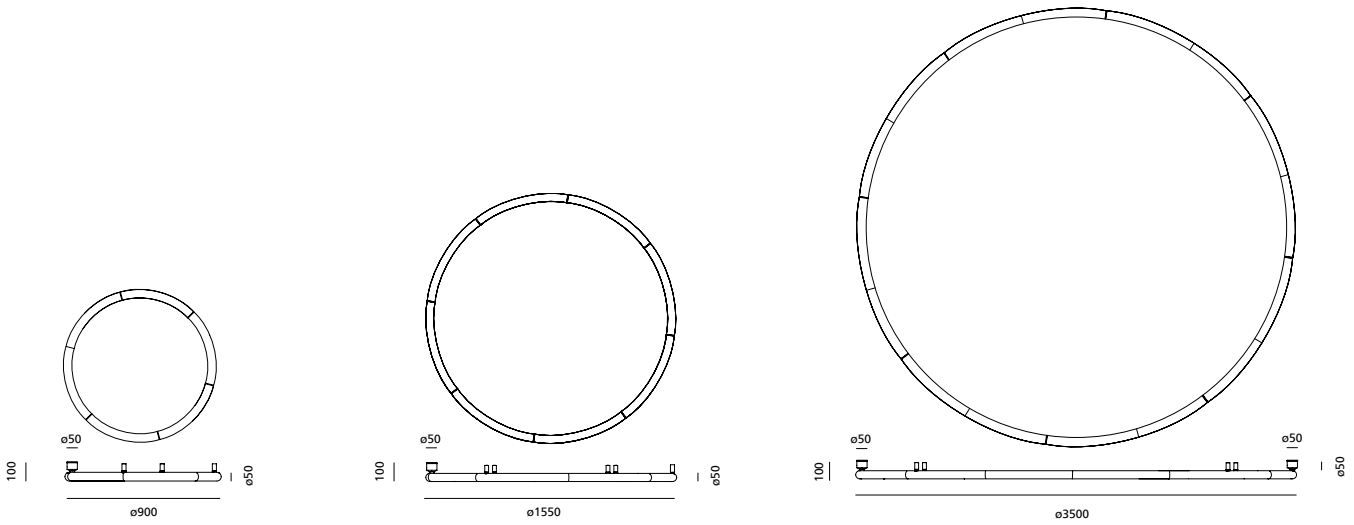

Model	Driver	Vac	Pw	L _{mm}	W _{mm}	H _{mm}		Code
Circular Ø90	CC 1400mA	220-240	55	130	76	30	DALI / 1-10 / PUSH	DV1034
Circular Ø90	CC 1400mA	220-240	55	130	76	30	APP / PUSH	DV1034APP
Circular Ø155	CC 1200+1200mA	220-240	91	350	80	23	DALI / 1-10 / PUSH	DV1036
Circular Ø155	CC 1200+1200mA	220-240	91	350	80	23	APP / PUSH	DV1036APP
Circular Ø350	CC 1050+1050mA	220-240	141	350	80	23	DALI / 1-10 / PUSH	DV1109
Circular Ø350	CC 1050+1050mA	220-240	141	350	80	23	APP / PUSH	DV1109APP

ALPHABET OF LIGHT - CIRCULAR

Opal White



XF



*EDP compliance



EPDITALY0430
12/05/2023
www.epditaly.it

MacAdam 3SDCM
Life L70 (10K) 55000h
CRI =80

IP20



SUSPENSION

	W	Flux	CCT	DALI / PUSH Code	APP / PUSH Code
Circular ø 90	55 W	6040 lm	3000K	1206000A	1206000APP
Circular ø 155	91 W	10740 lm	3000K	1207000A*	1207000APP
Circular ø 350	180 W	21478 lm	3000K	1214000A	1214000APP

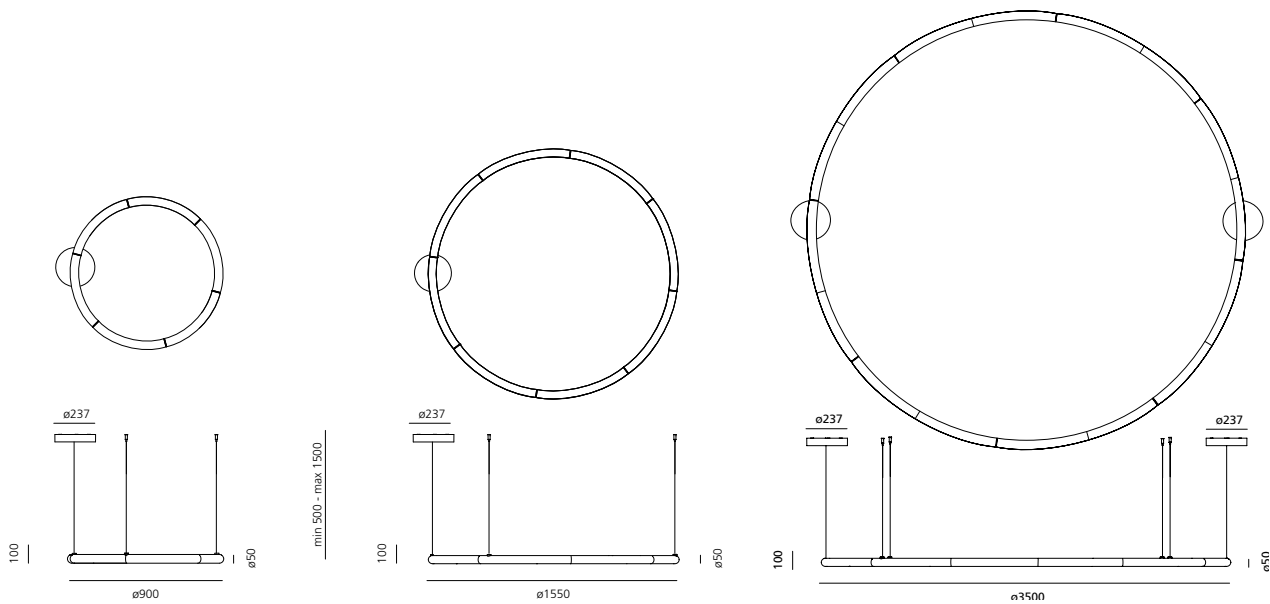

4 extension feeding cable of 4.5 m + 8 suspension wires L=6m for AoL circular Ø350
4.5 m extension feeding cable + 4 suspension wires L=6m for AoL circular Ø155
4.5 m extension feeding cable + 3 suspension wires L=6m for AoL circular Ø90

Code

1209200A

1209100A

1209000A

Optional control devices - BLL wireless switch



Device for switching and controlling Artemide App products.
Max N.3 inputs for external push buttons.
Max 1 m distance.
Mains power supply required.
To be installed inside flush mounting boxes or junction boxes.

Code

DV1080APP







TEATRO ARENA





Alphabet of light Letters & Letters Mini

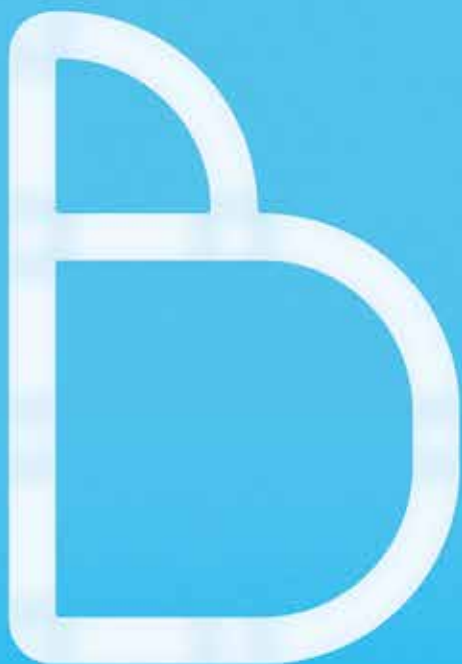

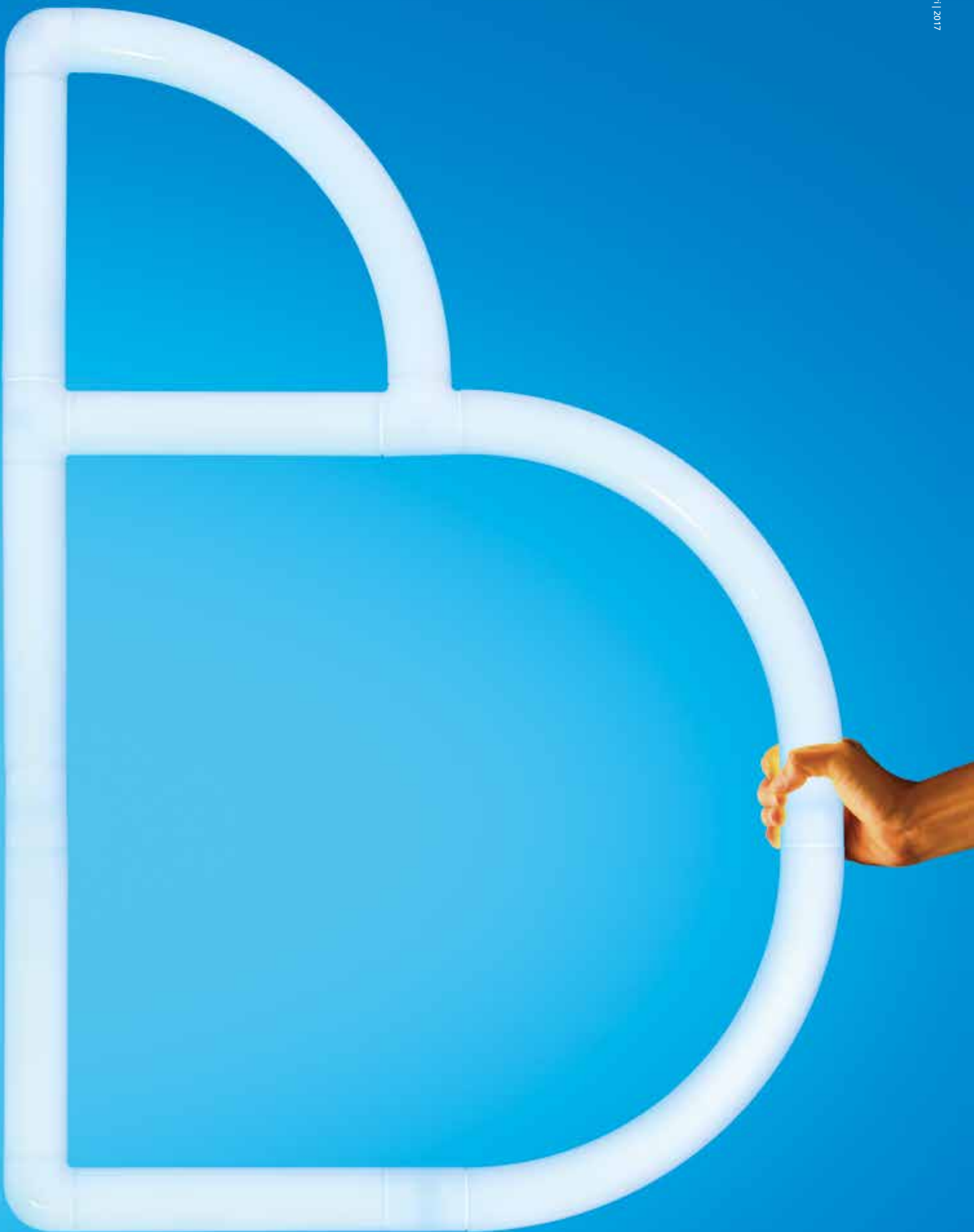





os over the lazy dog





*'There is nothing more beautiful than a way
out of their way to make the world better.'*
Henry David Thoreau

MDF SUPPORT INSTALLATION

The letters are provided mounted on MDF panels to allow installation on any kind of wall. Installation requires creating a counter-frame to accommodate the drivers, supplied separately, and the power cables.

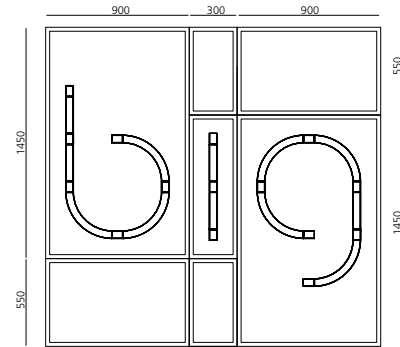

1. Create the supporting frame and provide for power connections for the individual letters.



2. Connect panel **b** to power source.



3. Fix panel **i** and connect panel **i** to power source.



4. Fix panel **i** and connect panel **g** to power source.



5. Fix panel **g** and close using the supplied panels.



6. Complete closing using the supplied panels.



7. Frame ready for finishing.



8. Apply the gauze and plaster flush with the gaps between panels.



9. Final painting.

CARDBOARD MOUNTING-SUPPORT INSTALLATION

The letters are provided with a packaging that ensures the right support during the installation process. This type of installation is suitable for existing drywalls that have accessible back space for the housing of drivers (code DV1009) supplied separately and cables (power supply 75 W max - 2 letters or more up to max 85% load).

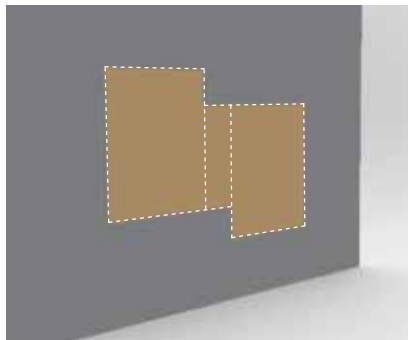
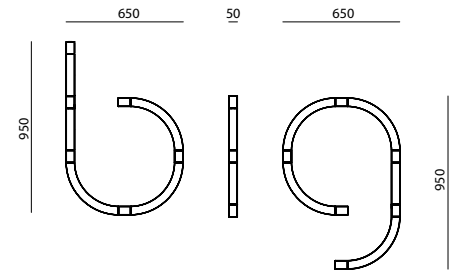

1. Drywall with accessible back space. Use the provided template to drill the holes and paint the drywall.



2. Install wall pins, identify output points and prepare wiring connections.



3. Connection of letter **b** to first wall output.



4. Attachment of letter **b** on wall pins.



5. Detail of the wall pins fixing.



6. Detail of the wall pins fixing.



7. Removal of the nylon wrapper.

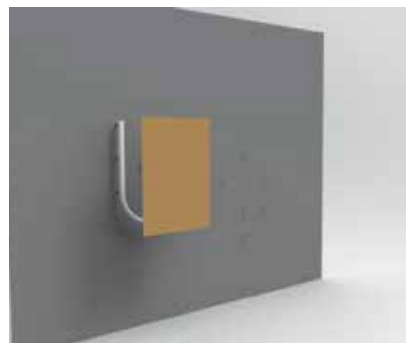

8. Removal of the cardboard support.



9. Repeat the procedure for the other letters. Finished.

ALPHABET OF LIGHT - LETTERS

Opal White

XF



24VDC Driver supplied separately.

MacAdam 3SDCM
Life L70 (6K) 36000h
CRI =80

IP20
⊕

Size			
Letter	W	Flux	H x L
A	36 W	3060 lm	950 x 650
B	38 W	3240 lm	950 x 650
C	22 W	1962 lm	950 x 650
D	36 W	3024 lm	950 x 650
E	30 W	2538 lm	950 x 650
F	22 W	1890 lm	950 x 650
G	24 W	2079 lm	950 x 650
H	32 W	2664 lm	950 x 650
I	12 W	1008 lm	950 x 50
J	24 W	2079 lm	950 x 650
K	30 W	2556 lm	950 x 650
L	20 W	1656 lm	950 x 650
M	46 W	3834 lm	950 x 950
N	30 W	2520 lm	950 x 650
O	32 W	2808 lm	950 x 650
P	32 W	2718 lm	950 x 650
Q	36 W	3150 lm	950 x 650
R	36 W	3060 lm	950 x 650
S	26 W	2295 lm	950 x 650
T	20 W	1674 lm	950 x 650
U	28 W	2412 lm	950 x 650
V	30 W	2520 lm	950 x 650
W	46 W	3834 lm	950 x 950
X	32 W	2664 lm	950 x 900
Y	24 W	2106 lm	950 x 650
Æ	50 W	4176 lm	950 x 950
Ø	44 W	3780 lm	950 x 650
À	42 W	3600 lm	950 x 650
Z	32 W	2736 lm	950 x 650

Size	
Letters	+ MDF Support
1201A00A	1211A00A
1201B00A	1211B00A
1201C00A	1211C00A
1201D00A	1211D00A
1201E00A	1211E00A
1201F00A	1211F00A
1201G00A	1211G00A
1201H00A	1211H00A
1201I00A	1211I00A
1201J00A	1211J00A
1201K00A	1211K00A
1201L00A	1211L00A
1201M00A	1211M00A
1201N00A	1211N00A
1201O00A	1211O00A
1201P00A	1211P00A
1201Q00A	1211Q00A
1201R00A	1211R00A
1201S00A	1211S00A
1201T00A	1211T00A
1201U00A	1211U00A
1201V00A	1211V00A
1201W00A	1211W00A
1201X00A	1211X00A
1201Y00A	1211Y00A
1201AE00A	1211AE00A
1201S00A	1211S00A
1201E00A	1211E00A
1201Z00A	1211Z00A

Size			
Letter	W	Flux	H x L
0	32 W	2808 lm	950 x 650
1	26 W	2205 lm	950 x 650
2	32 W	2835 lm	950 x 650
3	26 W	2304 lm	950 x 650
4	26 W	2214 lm	950 x 650
5	34 W	2943 lm	950 x 650
6	28 W	2502 lm	950 x 650
7	22 W	1872 lm	950 x 650
8	40 W	3456 m	950 x 650
9	28 W	2502 lm	950 x 650

Size	
Letters	+ MDF Support
1200000A	1210000A
1200100A	1210100A
1200200A	1210200A
1200300A	1210300A
1200400A	1210400A
1200500A	1210500A
1200600A	1210600A
1200700A	1210700A
1200800A	1210800A
1200900A	1210900A

Size			
Letter	W	Flux	H x L
a	22 W	1971 lm	650 x 650
b	26 W	2295 lm	950 x 650
c	18 W	1638 lm	650 x 650
d	26 W	2295 lm	950 x 650
e	22 W	1971 lm	650 x 650
f	18 W	1557 lm	950 x 350
g	28 W	2502 lm	950 x 650
h	26 W	2214 lm	950 x 650
i	8 W	684 lm	650 x 50
j	14 W	1215 lm	950 x 350
k	26 W	2223 lm	950 x 650
l	12 W	1008 lm	950 x 50
m	34 W	2862 lm	650 x 950
n	22 W	1872 lm	650 x 650
o	24 W	2160 lm	650 x 650
p	26 W	2295 lm	950 x 650
q	26 W	2295 lm	950 x 650
r	14 W	1233 lm	650 x 350
s	24 W	2079 lm	650 x 650
t	18 W	1557 lm	950 x 350
u	22 W	1872 lm	650 x 650
v	20 W	1746 lm	650 x 650
w	28 W	2394 lm	650 x 950
x	16 W	1368 lm	650 x 650
y	28 W	2421 lm	950 x 650
æ	34 W	3069 lm	650 x 950
ø	32 W	2808 lm	650 x 650
à	28 W	2511 lm	650 x 650
z	28 W	2421 lm	650 x 650

Size	
Letters	+ MDF Support
1202a00A	1212a00A
1202b00A	1212b00A
1202c00A	1212c00A
1202d00A	1212d00A
1202e00A	1212e00A
1202f00A	1212f00A
1202g00A	1212g00A
1202h00A	1212h00A
1202i00A	1212i00A
1202j00A	1212j00A
1202k00A	1212k00A
1202l00A	1212l00A
1202m00A	1212m00A
1202n00A	1212n00A
1202o00A	1212o00A
1202p00A	1212p00A
1202q00A	1212q00A
1202r00A	1212r00A
1202s00A	1212s00A
1202t00A	1212t00A
1202u00A	1212u00A
1202v00A	1212v00A
1202w00A	1212w00A
1202x00A	1212x00A
1202y00A	1212y00A
1202ae00A	1212ae00A
1202S00A	1212S00A
1202E00A	1212E00A
1202z00A	1212z00A

Driver							
Driver	Vin (V)	Vout (V)	L _{mm}	W _{mm}	H _{mm}	IP	Code
75 W	220-240Vac	24Vdc	180	52	30	20 Undimmable	DV1009





Broken Nature "La Nazione delle Piante", XXII International Exhibition, Triennale di Milano, Ph. Federico Villa | 2017

355 | 245 |
A

355 | 245 |
B

355 | 245 |
C

355 | 245 |
D

355 | 245 |
E

355 | 245 |
F

355 | 245 |
G

355 | 245 |
H

355 | 25 |
I

355 | 245 |
J

355 | 245 |
K

355 | 245 |
L

355 | 355 |
M

355 | 245 |
N

355 | 245 |
O

355 | 245 |
P

355 | 245 |
Q

355 | 245 |
R

355 | 245 |
S

355 | 245 |
T

355 | 245 |
U

355 | 245 |
V

355 | 355 |
W

355 | 343 |
X

355 | 245 |
Y

355 | 355 |
Æ

355 | 245 |
Ø

433 | 245 |
Å

355 | 245 |
Œ

ALPHABET OF LIGHT - LETTERS MINI

Opal White 	XF 	24VDC Driver supplied separately.	MacAdam 3SDCM Life L70 (10K) 102000h CRI =90	IP20
----------------	--------	-----------------------------------	--	----------

Size				Letters
Letter	W	Flux	H x L	
A	11 W	1151 lm	355 x 245	1215A00A
B	12 W	1233 lm	355 x 245	1215B00A
C	7 W	740 lm	355 x 245	1215C00A
D	11 W	1151 lm	355 x 245	1215D00A
E	9 W	946 lm	355 x 245	1215E00A
F	7 W	699 lm	355 x 245	1215F00A
G	8 W	781 lm	355 x 245	1215G00A
H	10 W	986 lm	355 x 245	1215H00A
I	4 W	370 lm	355 x 25	1215I00A
J	8 W	781 lm	355 x 245	1215J00A
K	9 W	946 lm	355 x 245	1215K00A
L	6 W	616 lm	355 x 245	1215L00A
M	14 W	1439 lm	355 x 355	1215M00A
N	9 W	946 lm	355 x 245	1215N00A
O	11 W	1069 lm	355 x 245	1215O00A
P	10 W	1027 lm	355 x 245	1215P00A
Q	12 W	1192 lm	355 x 245	1215Q00A
R	11 W	1151 lm	355 x 245	1215R00A
S	9 W	863 lm	355 x 245	1215S00A
T	6 W	616 lm	355 x 245	1215T00A
U	9 W	905 lm	355 x 245	1215U00A
V	9 W	946 lm	355 x 245	1215V00A
W	14 W	1439 lm	355 x 355	1215W00A
X	10 W	986 lm	343 x 343	1215X00A
Y	8 W	781 lm	355 x 245	1215Y00A
Æ	15 W	1562 lm	355 x 355	1215Æ00A
Ø	14 W	1439 lm	355 x 245	1215Ø00A
À	13 W	1357 lm	433 x 245	1215À00A
Z	10 W	1027 lm	355 x 245	1215Z00A

Driver

Driver	V _{in} (V)	V _{out} (V)	L _{mm}	W _{mm}	H _{mm}	IP	Code
75 W	220-240Vac	24Vdc	180	52	30	20	Undimmable DV1009
30 W	220-240Vac	24Vdc	153	41	32	20	Undimmable DV1032
Dimmer	24Vdc	24Vdc PWM	80	54	24	20	Dimmable DV1048

Dali/0-10V/Push

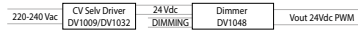



BIG



Alphabet of light and Gople system are compatible with **Artemide App**

Artemide App is a user-friendly and intuitive interface used to control individual products, groups of appliances and lighting scenarios. It is a tool that can be associated with several products from both the Design and the Architectural Catalogues.



Download Artemide App
and find more information on
artemide.com

Headquarters

Artemide S.p.A.

Via Bergamo, 18
20006 Pregnana Milanese (MI), Italy
Tel. +39 02 93518.1
Tel. +39 02 93526.1
Numero verde 800 834 093
(from Italy only)
info@artemide.com
artemide.com

Artemide S.p.A.

si riserva la facoltà di modificare, in qualunque momento e senza preavviso, le caratteristiche tecniche degli elementi illustrati nel presente catalogo.

Artemide S.p.A.

reserves the right to change, at any time and without prior warning, the technical specifications of any product illustrated in this catalogue.

Artemide S.p.A.

se réserve le droit de modifier, à n'importe quel moment et sans préavis, les caractéristiques techniques des éléments illustrés dans ce catalogue.

Artemide S.p.A.

behält sich das Recht vor jederzeit und ohne Ankündigung die technischen Daten der im Katalog abgebildeten Produkte zu ändern.

Artemide S.p.A.

se reserva la facultad de modificar, en cualquier y sin aviso previo, las características técnicas de los elementos ilustrados en el presente catálogo.