



Sylt

Carlotta de Bevilacqua

Artemide[®]



Sylt

Carlotta de Bevilacqua
2023

PATENT OF INVENTION: STRUCTURE



Artemide
App



Sylt takes the concept of a track capable of powering and supporting multiple lighting elements to the extreme, providing both high-tech and expressive beauty. The section of Sylt is just 20 x 5 mm, which can be bent at the construction site, simply, to accommodate any geometric shapes dictated by the lighting requirements and by the architecture. It is possible to outline curves that are accentuated to different extents, free and sinuous shapes that come together with a wealth of light performance. The project overcomes architectural and installation constraints in terms of layout and time. The profile dialogues with the architectural space following light needs through its ceiling version.



For further information on Sylt
visit artemide.com



Sylt is versatile

Free composition on site

Combination of lighting languages

Integration of different performances





Thermoplastic
elastomer
co-extruded with
copper conductors
positive & negative
poles

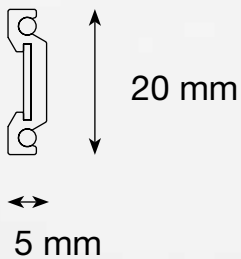

Minimum dimensions

In a minimum section the two copper conductors, co-extruded with a section of thermoplastic elastomer, are left exposed to view yet fully safe.

A slim band of harmonic steel runs along the back, forming the profile and allowing the different geometric shapes to be plied and retained. The track turns into a belt which can be bent at the construction site, simply, to accommodate any geometric shape dictated by the lighting requirements and by the architecture.



Harmonic steel



Sustainability in space

Thanks to its materic features, the track can be cut and folded in place with a minimum radius of 300 mm.

Minimum curvature radius

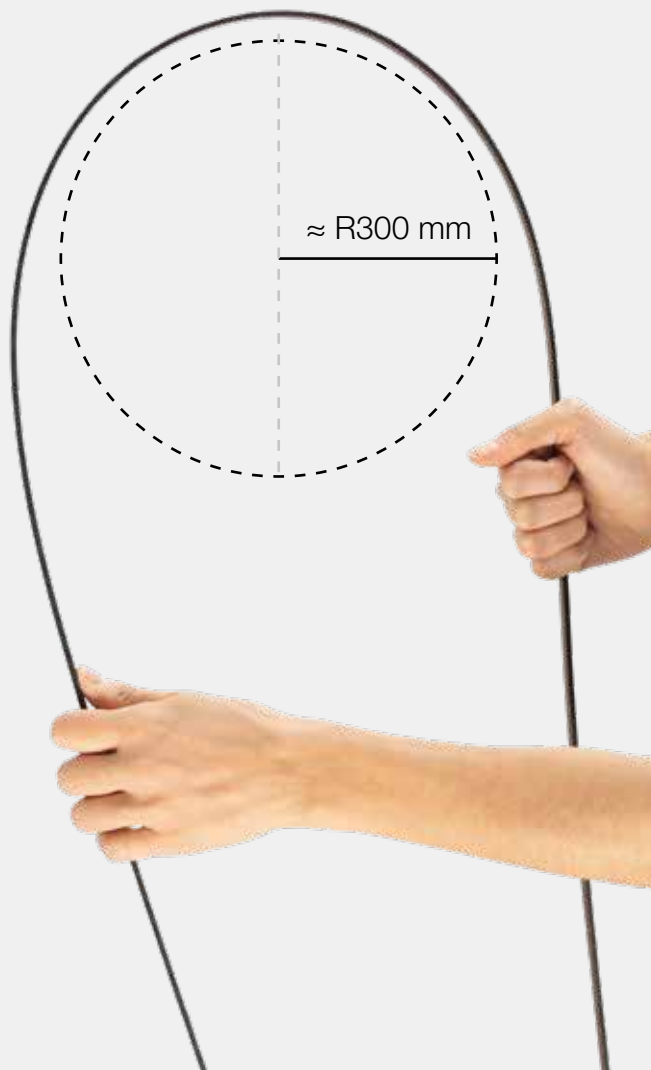

Track delivery



Sustainability in time

Efficient installation timing

Sylt is a system designed to maximise intelligence and performance through the reduction of mechanical components. The elements required for the functioning of the system are:

- the energetic infrastructure consisting of the cable, designed to be a synthesis of mechanics and electronics;
- the mechanical fixing elements reduced to only two types and three sizes (Track support 84 and Mechanical and insulator track support 84) that can be installed approximately every meter;
- the powering element of the system that also acts as a mechanical fastener (Powered track support 84);
- power supplying elements that allow different available powers, various dimming modes and multiple installation possibilities.

Riconfigurability over time

Lighting appliances, that share with the system the form factor of the electro-mechanical fixing element, complete the setup. The simplicity is reflected in a rapid installation that can be completed in just a few steps.

The system is sustainable over time allowing both minimal installation time as well as the possibility to reconfigure the layout, being able to dynamically and sustainably address project needs over time.

Easiness of installation

To install Sylt, it is necessary to secure only the fixing elements (Track supports), discrete and at an indicative distance of approximately maximum 1 m from each other. Each support is fixed with only two screws: one for fixing to the ceiling and the other for closing the cover. The flexible track must be inserted in the correct direction to ensure its power supply.

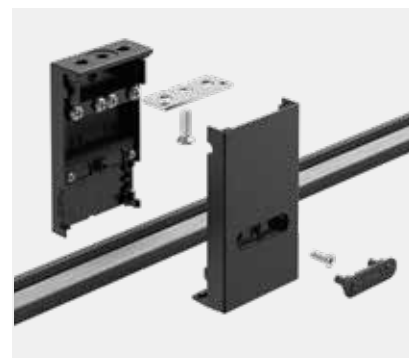

1.

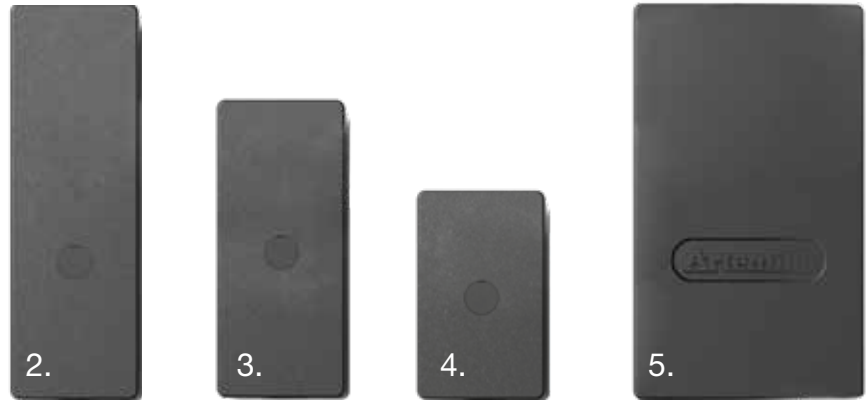

COMPONENTS ABACUS

1. Track
thermoplastic elastomer
co-extruded
with copper conductors
20 x 5 mm
Harmonic steel
10 x 1 mm
- Track support 84
29 x 84 x 20 mm
3. Track support 60
29 x 60 x 20 mm
4. Track support 40
29 x 40 x 20 mm
5. Mechanical and insulator
track support 84
48 x 84 x 20 mm
6. Powered track support 84
48 x 84 x 20 mm
7. Lighting appliance
example with Helgoland 90

Front

Back

Spatial Freedom and Intelligence

48V Intelligence

Long run with one driver for 20 m

Sylt completes Artemide latest generation of systems powered by *48V Intelligence*.

This feeding mode in Sylt optimises the distance covered by a single feeding point up to 20m. The system can be fed at any point, allowing maximum flexibility in adapting to existing installations. A variety of power supply kits, in terms of power sizes, dimming modes and installation typologies ensure a wide range of possibilities to cope with different project contexts.

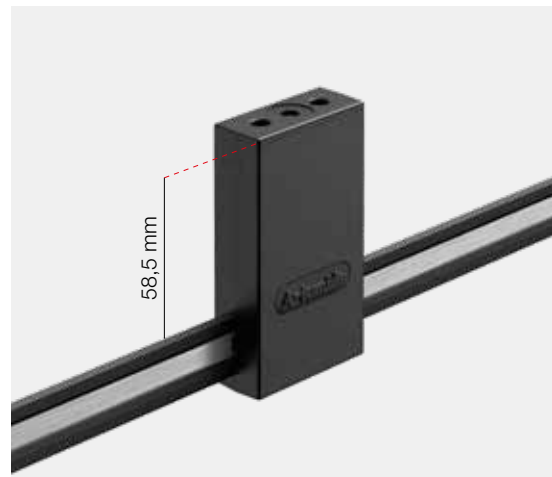

Electrical feeding alternatives

Power/Distance

*Track length + feeding wire length \leq 22m.

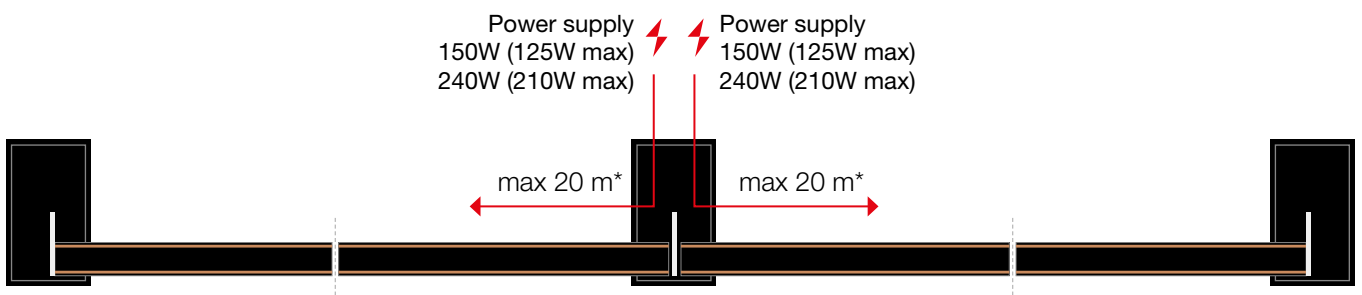
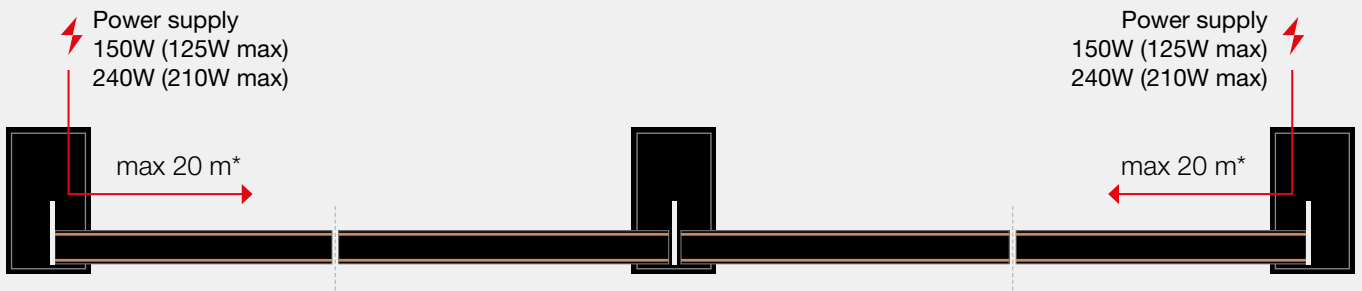
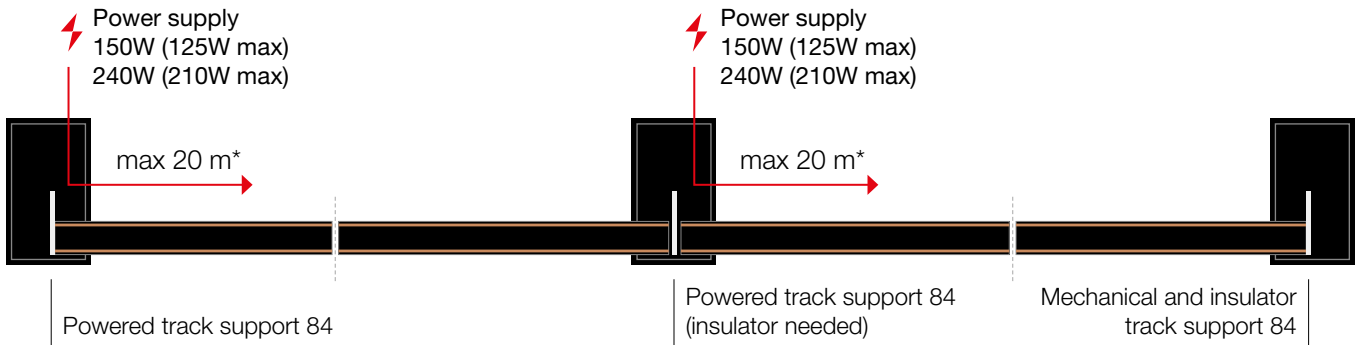
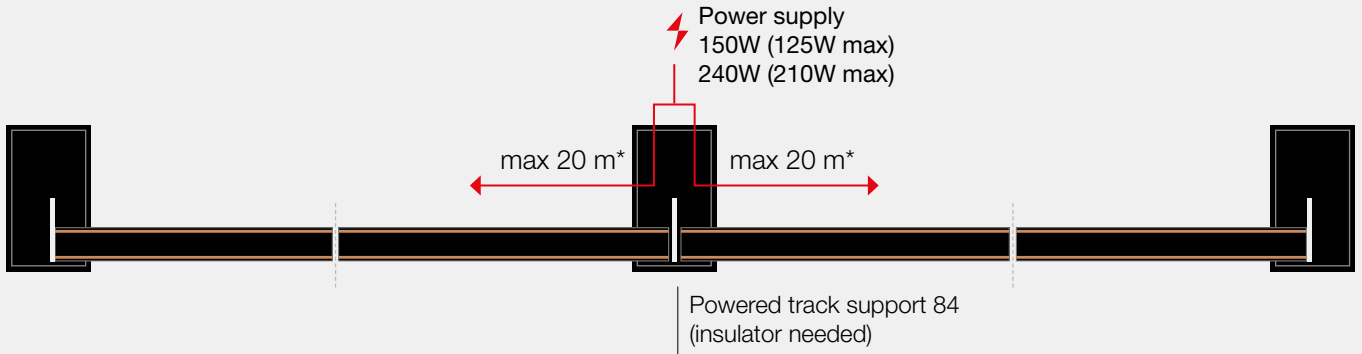

Spatial Freedom and Intelligence

48V Intelligence

Powering & data synthesis for dimming

The *48V Intelligence* communication system is based on using the 48V power supply line to transmit information to receiving devices. The distinguishing feature of this technology is the synthesis of power supply and data transmission. Through a proprietary high-frequency coding protocol, developed to ensure high transmission reliability, the consistency of the valid lighting level being transmitted is preserved, ensuring alignment between the transmitter and receivers.

In terms of compatibility, Syt's *48V Intelligence* supports various control standards, including DALI2, normally open button inputs, and active 0-10V analogue signals. This versatility makes it suitable for a wide range of application scenarios, ensuring optimised, interference-free operation on receiving devices.

The use of the *48V Intelligence* solution, through the elimination of separate wiring for data transmission, greatly simplifies the installation or implementation of lighting systems, reducing cost and complexity while ensuring reliable communication and high performance.

Power supply kit alternatives

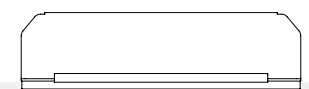
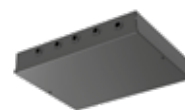

Installation type	SMD	Recessed Trimless	Remoted
Power (W)	150W (125W max) 240W (210W max)	150W (125W max) 240W (210W max)	150W (125W max) 240W (210W max)
Max feeding wire length*	2m (with wire 2 x 0,75 mm ²) ¹ 5m (with wire 2 x 1,5 mm ²) ² 10m (with wire 2 x 2,5 mm ²) ²	2m (with wire 2 x 0,75 mm ²) ¹ 5m (with wire 2 x 1,5 mm ²) ² 10m (with wire 2 x 2,5 mm ²) ²	2m (with wire 2 x 0,75 mm ²) ¹ 5m (with wire 2 x 1,5 mm ²) ² 10m (with wire 2 x 2,5 mm ²) ²
	110-240V	110-240V	110-240V
Appliances dimming	Broadcast	Broadcast	Broadcast
Input dimming	0-10V/PUSH/DALI2 PUSH & APP	0-10V/PUSH/DALI2 PUSH & APP	0-10V/PUSH/DALI2 PUSH & APP

Mounting possibilities

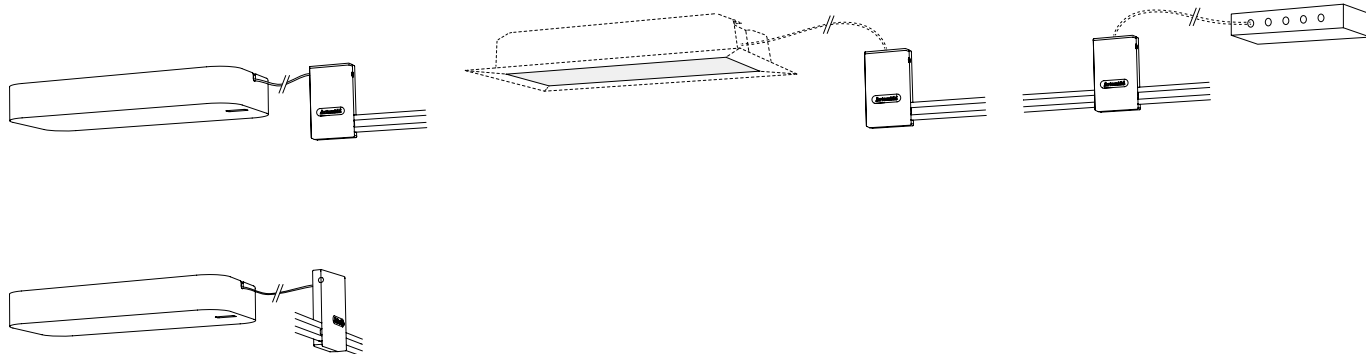

¹ Included in the Powered support track 84 component.

² To be provided by the installer.

* Track length + feeding wire length ≤ 22m.



Sustainability in performance

Insets can be changed over time, moved, substituted or added in very few operative steps: dismantled, moved or changed and fixed again.



Closed configurations





Sylt system can create both open and pure closed lighting configurations, able to adapt to different indoor environments and emphasise architectural details.





SYLT TRACK

Cutable on-site.
 Power supply kits and lighting appliances to be ordered separately.
 To properly operate, n.2 lighting appliances are needed for dimmable configurations.

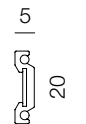
IP20

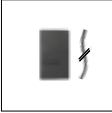
Track		Code
Length	Weight	
5000 mm	1,15 kg	CH01000
10000 mm	2,3 kg	CH01100
20000 mm	4,6 kg	CH01200

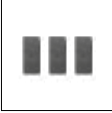



Accessories		Color	Code
	Powered track support 84 48x20x84h Included: 2000 mm cable (2 x 0,75 mm ²)	●	CH00000
	Mechanical and insulator track support 84 48x20x84h	●	CH00200
	Kit 3 track support 84 29x20x84h	●	CH00100
	Kit 3 track support 60 29x20x84h	●	CH00400
	Kit 3 track support 40 29x20x40h	●	CH00300

SYLT POWER SUPPLY KIT



IP20

Lighting appliances are not individually adressable (broadcast dimming).
Track length + feeding wire length ≤ 22m.



CEILING

Power supply	0-10/PUSH/DALI2 Code	PUSH & APP Code
 <p>150W SMD power supply kit Output max: 125W 110-240VAC-48VDC IP20 \oplus 306x140x43,5h</p>	DV1130	DV1130APP
 <p>240W SMD power supply kit Output max: 210W 110-240VAC-48VDC IP20 \oplus 306x140x43,5h</p>	DV1131	DV1131APP

RECESSED

Power supply	0-10/PUSH/DALI2 Code	PUSH & APP Code
 <p>150W Recessed Trimless power supply kit Output max: 125W 110-240VAC-48VDC IP20 \oplus 395x165x107h</p>	DV1132	DV1132APP
 <p>240W Recessed Trimless power supply kit Output max: 210W 110-240VAC-48VDC IP20 \oplus 395x165x107h</p>	DV1133	DV1133APP

REMOTE

Power supply	0-10/PUSH/DALI2 Code	PUSH & APP Code
 <p>150W Remote power supply kit Output max: 125W 110-240VAC-48VDC IP20 \oplus 313x243x57,5h</p>	DV1134	DV1134APP
 <p>240W Remote power supply kit Output max: 210W 110-240VAC-48VDC IP20 \oplus 313x243x57,5h</p>	DV1135	DV1135APP

W	Output max	Driver type	N. of power supply kits under same MCB 16A	Supply voltage	Output voltage	Class	Code	L _{mm}	W _{mm}	H _{mm}
150W	125W	0-10/PUSH/DALI2	B: 4	110-240V	48V <i>Intelligence</i>	\oplus	DV1130	306	140	43,5
			C: 7				DV1132	395	165	107
			D: 14				DV1134	313	243	57,5
		PUSH & APP	B: 4				DV1130APP	306	140	43,5
			C: 7				DV1132APP	395	165	112
			D: 14				DV1134APP	313	243	57,5
240W	210W	0-10/PUSH/DALI2	B: 3	110-240V	48V <i>Intelligence</i>	\oplus	DV1131	306	140	43,5
			C: 6				DV1133	395	165	112
			D: 12				DV1135	313	243	57,5
		PUSH & APP	B: 3				DV1131APP	306	140	43,5
			C: 6				DV1133APP	395	165	112
			D: 12				DV1135APP	313	243	57,5





**Universal
inclusivity**

Sylt lighting appliances

Integrating different performances

Helgoland 90
Carlotta de Bevilacqua
Ø90 x 13 mm
Total Power: 6,5W

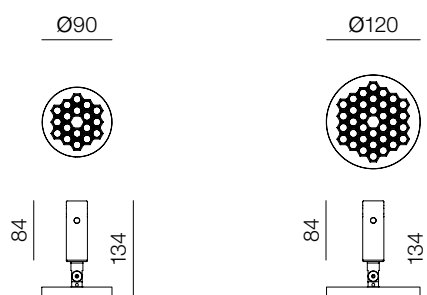

Helgoland 120
Carlotta de Bevilacqua
Ø120 x 13 mm
Total Power: 9W



Vector 30
Carlotta de Bevilacqua
Ø30 x h 77 mm
Total Power: 7W

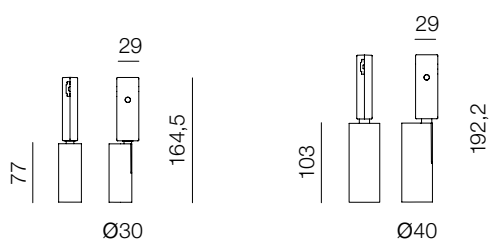

Vector 40
Carlotta de Bevilacqua
Ø40 x h 103 mm
Total Power: 10W



Linea 25
BIG - Bjarke Ingels Group
Ø25 x 2500 mm
Total Power: 29W

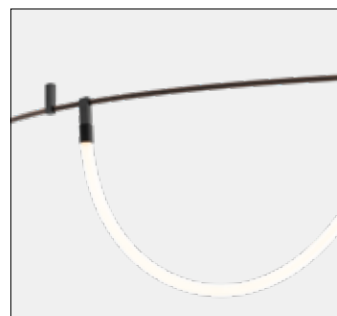
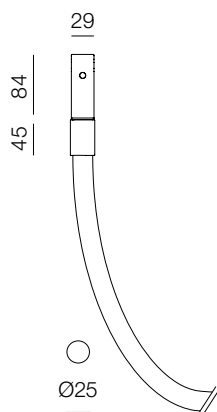

Diffused linear 600
 Carlotta de Bevilacqua
 599 x 29 x 20 mm
 Total Power: 15W

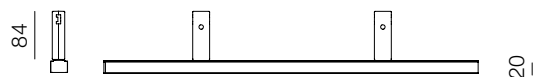

Diffused linear 1200
 Carlotta de Bevilacqua
 1187 x 29 x 20 mm
 Total Power: 30W

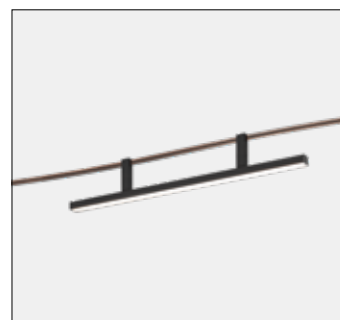
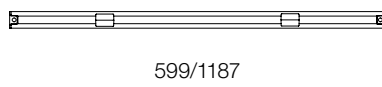

Gople Mini
 BIG - Bjarke Ingels Group
 Ø145 x h 294 mm
 Suspension cable length:
 max 1200 mm
 Total Power: 9W

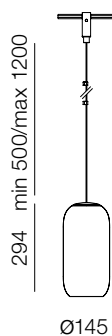

Sphere 9
 Carlotta de Bevilacqua
 Ø90 x h 119 mm
 Suspension cable length:
 max 1200 mm
 Total Power: 4W

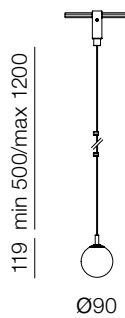
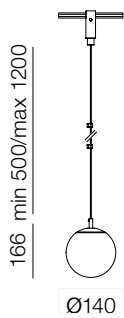

Sphere 14
 Carlotta de Bevilacqua
 Ø140 x h 166 mm
 Suspension cable length:
 max 1200 mm
 Total Power: 9W

Unterlinden
 Herzog & de Meuron
 Ø117 x h 97 mm
 Suspension cable length:
 max 1200 mm
 Total Power: 7W

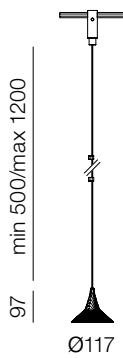

LIGHT APPLIANCES SYLT

White 01	Black 04	Cobalt blue 02	Copper 03	Silver 05	FL 28°	WF 38°	XF 60°	MacAdam 3SDCM Life L70(17k) 102000h CRI = 90	IP20 ±90° 360°
-------------	-------------	-------------------	--------------	--------------	--------	--------	--------	--	----------------------

HELGOLAND

W	Size	Weight	Current	Beam	Flux	CCT	Code				
6,5W	90 mm	0,21 kg	350 mA	FL 28°	712 lm	2700K	CH540. 01/04/02/03/05				
					756 lm	3000K	CH530. 01/04/02/03/05				
					756 lm	4000K	CH535. 01/04/02/03/05				
				WF 38°	842 lm	2700K	CH541. 01/04/02/03/05				
					893 lm	3000K	CH531. 01/04/02/03/05				
					893 lm	4000K	CH536. 01/04/02/03/05				
				XF 60°	819 lm	2700K	CH542. 01/04/02/03/05				
					869 lm	3000K	CH532. 01/04/02/03/05				
					869 lm	4000K	CH537. 01/04/02/03/05				
				9W	120 mm	0,30 kg	500 mA	FL 28°	1018 lm	2700K	CH570. 01/04/02/03/05
									1080 lm	3000K	CH560. 01/04/02/03/05
									1080 lm	4000K	CH565. 01/04/02/03/05
WF 38°	1204 lm	2700K	CG571. 01/04/02/03/05								
	1277 lm	3000K	CH561. 01/04/02/03/05								
	1277 lm	4000K	CH566. 01/04/02/03/05								
XF 60°	1172 lm	2700K	CH572. 01/04/02/03/05								
	1243 lm	3000K	CH562. 01/04/02/03/05								
	1243 lm	4000K	CH567. 01/04/02/03/05								

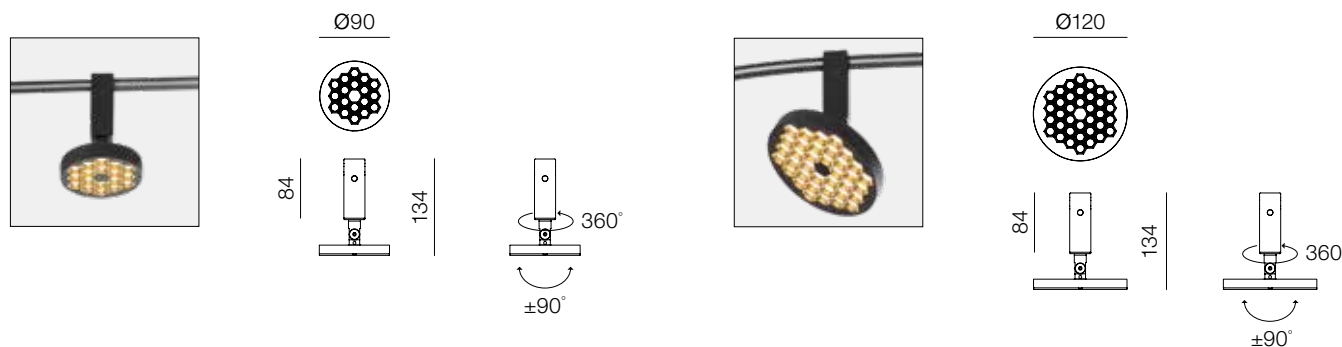



LIGHT APPLIANCES SYLT



MacAdam 3SDCM
 Vector 40 FL/WF: MacAdam 2SDCM
 Life L70 (9K) 50000h
 CRI = 90

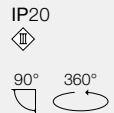

VECTOR

Vector 30						Dimmable ¹
W	Weight	Current	Beam	Flux	CCT	Code
6,5W	0,12 kg	450 mA	SP 12°	329 lm	2700K	CH400. 01/04
				329 lm	3000K	CH405. 01/04
				329 lm	4000K	CH410. 01/04
			FL 16°	335 lm	2700K	CH401. 01/04
				335 lm	3000K	CH406. 01/04
				335 lm	4000K	CH411. 01/04
WF 30°	292 lm	2700K	CH402. 01/04			
	292 lm	3000K	CH407. 01/04			
	292 lm	4000K	CH412. 01/04			

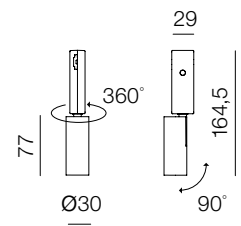

Vector 40						Dimmable ¹	
W	Weight	Current	Beam	Flux	CCT	Code	
9W	0,22 kg	700 mA	SP 14°	544 lm	2700K	CH430. 01/04	
				541 lm	3000K	CH435. 01/04	
				541 lm	4000K	CH440. 01/04	
				FL 21°	543 lm	2700K	CH431. 01/04
					584 lm	3000K	CH436. 01/04
					626 lm	4000K	CH441. 01/04
			WF 28°	491 lm	2700K	CH432. 01/04	
				529 lm	3000K	CH437. 01/04	
				566 lm	4000K	CH442. 01/04	

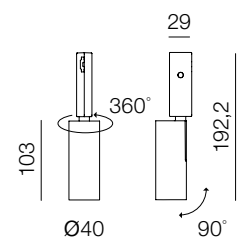

¹ Use of Artemide power units is mandatory.



LIGHT APPLIANCES SYLT

For layout with Linea 25 surmounting the track, track support 84 and 60 are needed.

MacAdam 3SDCM
Life L70(6k) 36000h
CRI = 90

IP20

LA LINEA 25

Lenght	W	Weight	Current	Flux	CCT	Dimmable Code
2500 mm	29W	1,7 kg	800 mA	3000 lm	3000K	CH20000

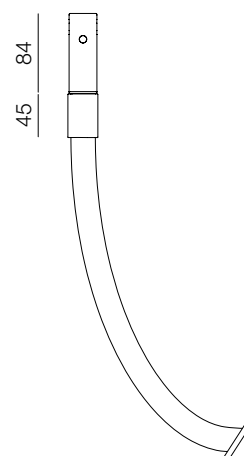
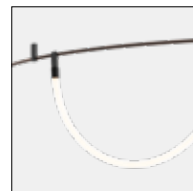

○
Ø25
—



LIGHT APPLIANCES SYLT

Black



04

MacAdam 3SDCM IP20
 Life L70(17k) 102000h
 CRI = 90

SYLT DIFFUSED ELEMENTS

Lenght	W	Weight	Current	Flux	CCT	Dimmable Code
600 mm	15W	0,5 kg	400 mA	1340 lm	2700K	CH10004
				1421 lm	3000K	CH10304
				1421 lm	4000K	CH10604
1200 mm	30W	0,8 kg	800 mA	2680 lm	2700K	CH12004
				2843 lm	3000K	CH12304
				2843 lm	4000K	CH12604

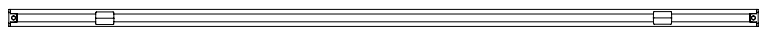
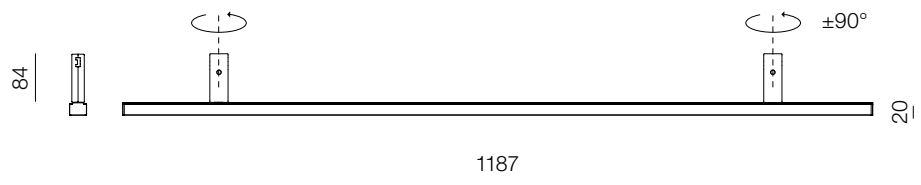
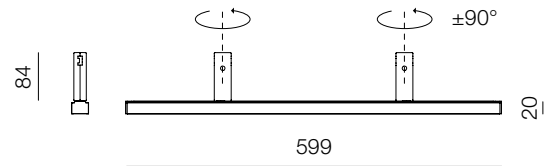



LIGHT APPLIANCES SYLT

White



01

MacAdam 3SDCM
Life L70(9k) 50000h
CRI = 90

IP20

GOPLE MINI

W	Weight	Current	Flux	CCT	Dimmable
9W	1,3 kg	250 mA	755 lm	2700K	Code
			850 lm	3000K	CH30001
					CH30301

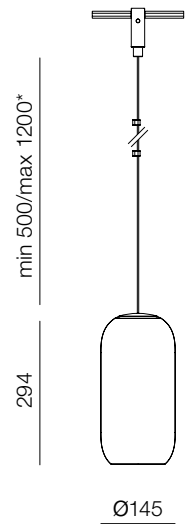
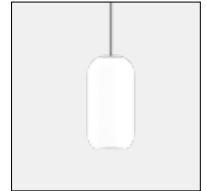

*No cuttable wire.
Clips included to adjust the length.



LIGHT APPLIANCES SYLT

MacAdam 2SDCM
 Life L70(9k) 50000h
 CRI = 90



SPHERE

Sphere 9					Dimmable
W	Weight	Current	Flux	CCT	Code
4W	0,3 kg	300 mA	346 lm	2700K	CH70000
			373 lm	3000K	CH70300

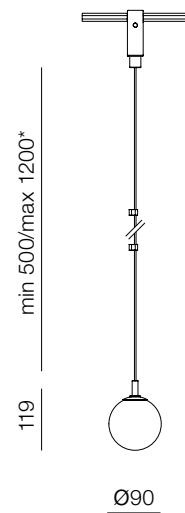
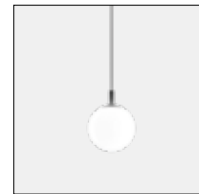

Sphere 14					Dimmable
W	Weight	Current	Flux	CCT	Code
9W	0,6 kg	700 mA	628 lm	2700K	CH80000
			760 lm	3000K	CH80300

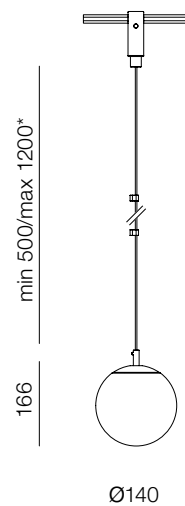
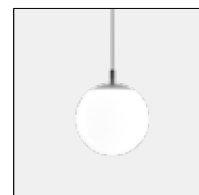

*No cuttable wire.
 Clips included to adjust the length.



LIGHT APPLIANCES SYLT

Brass Aluminum



01



02

2700K: MacAdam 2SDCM
Life L70(19k) 105000h
3000K: MacAdam 3SDCM
Life L70(9k) 50000h
CRI = 90

IP20



UNTERLINDEN

W	Weight	Current	Flux	CCT	Dimmable
7W	0,3 kg	350 mA	398 lm 349 lm	2700K 3000K	Code CH600. 01/02 CH603. 01/02

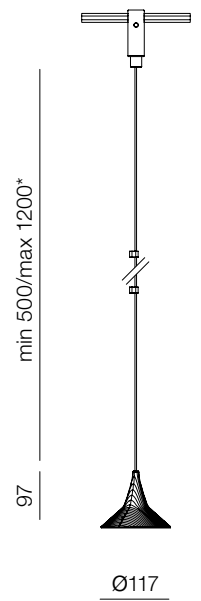

*No cuttable wire.
Clips included to adjust the length.







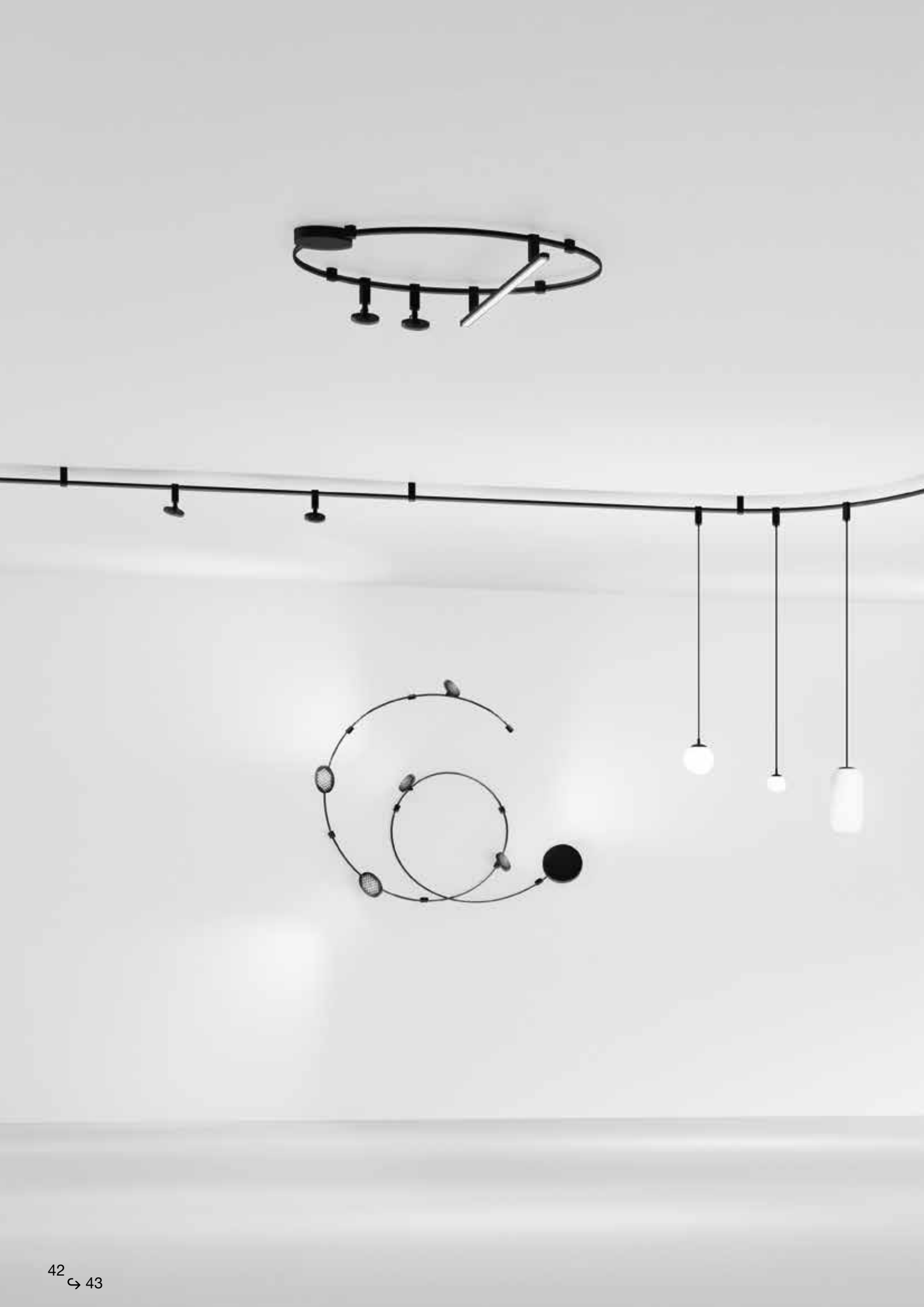

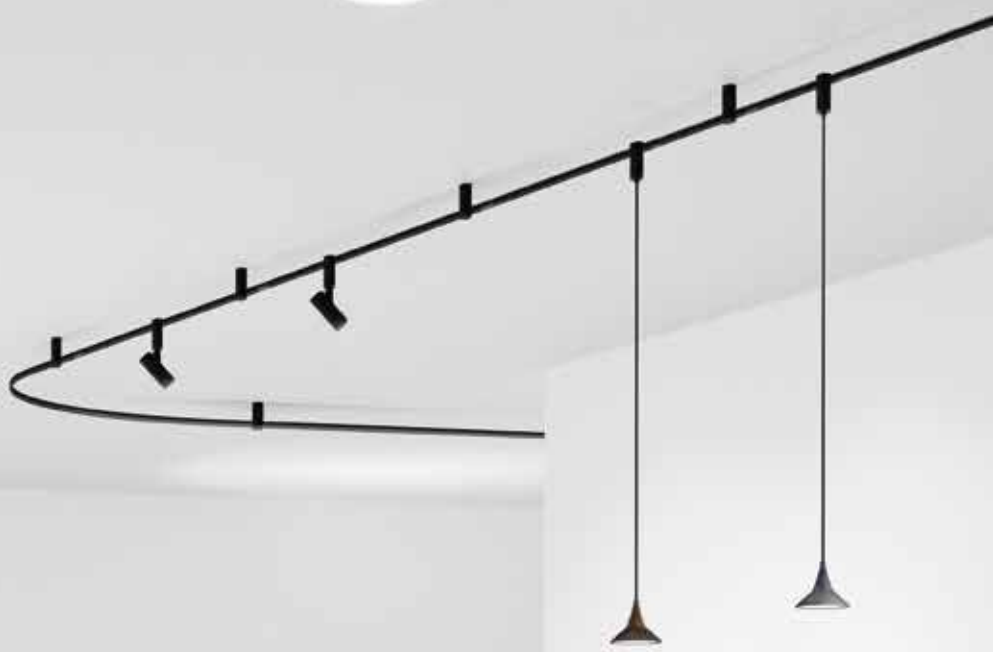
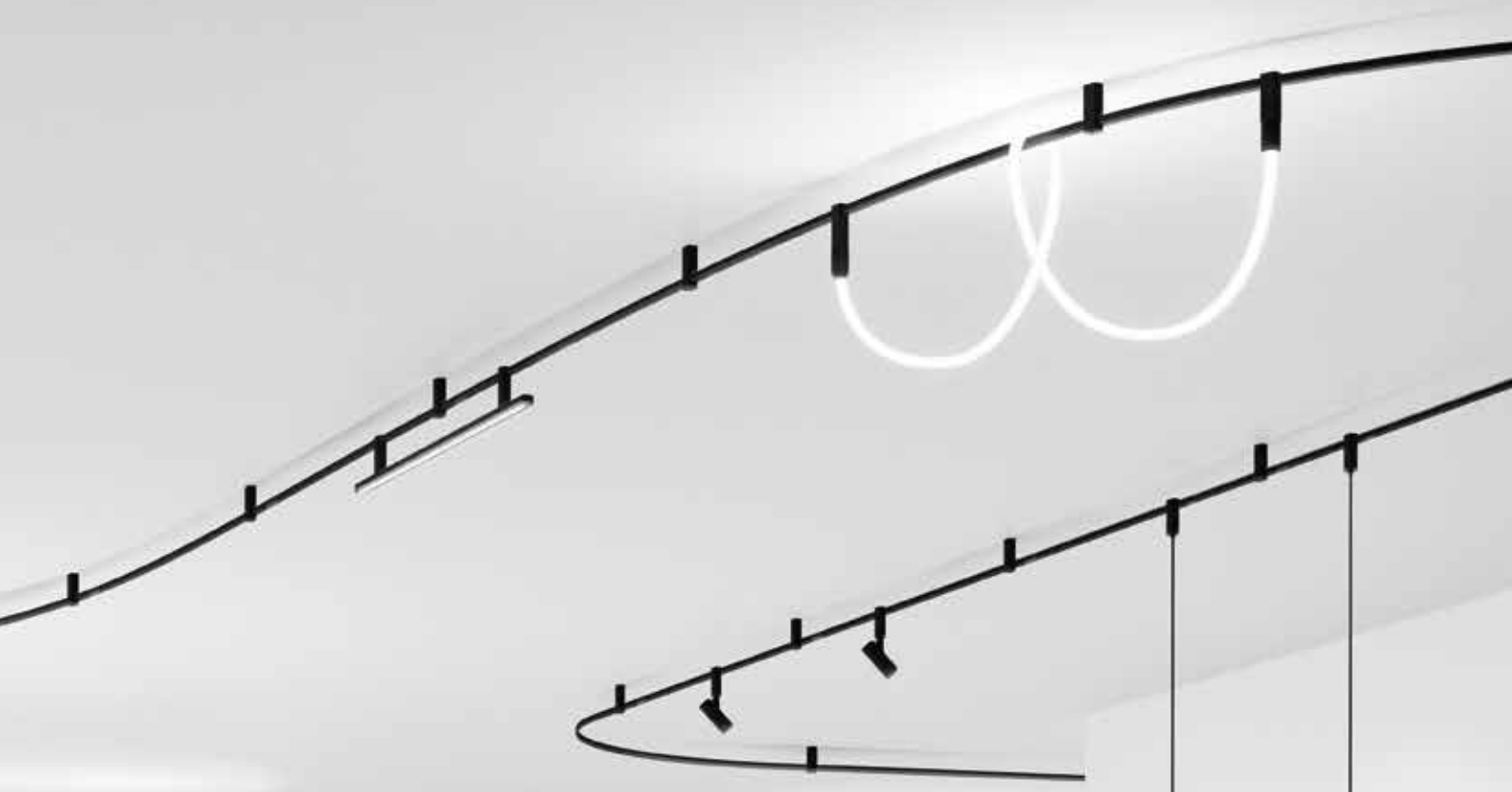

Sylt Stand alone

Ready-made energetic infrastructure

Sylt is also developed as a stand-alone element, a ready-made set to simplify application in standard installations such as residential settings. It allows you to design your own light by composing it with a kit complete with track, mounting accessories and power supply kit to which you can freely add light insets.

This version designed to draw graphic signs with which to illuminate and define a space introduces a mounting element that allows the track to be overlapped. The track supports come in two sizes to open up new compositional geometries.

Sylt stand alone can be installed on either wall or ceiling, with total compositional freedom within two constraints: a maximum track length of 5 meters and a minimum radius of 300 mm.

The choice of luminous lighting appliances depends on their placement in the space.

On the wall, accent lighting is achieved through Helgoland and Vector spotlights, while the ceiling version allows to more expressive light languages, as seen in the systemic version. Sylt's electronic innovation is also present in the stand alone version, thanks to the application of the 48V *Intelligence* system and the possibility of managing light intensity in broadcast mode via various dimming protocols, including wireless with Artemide APP.





Sylt stand alone

Complete kit

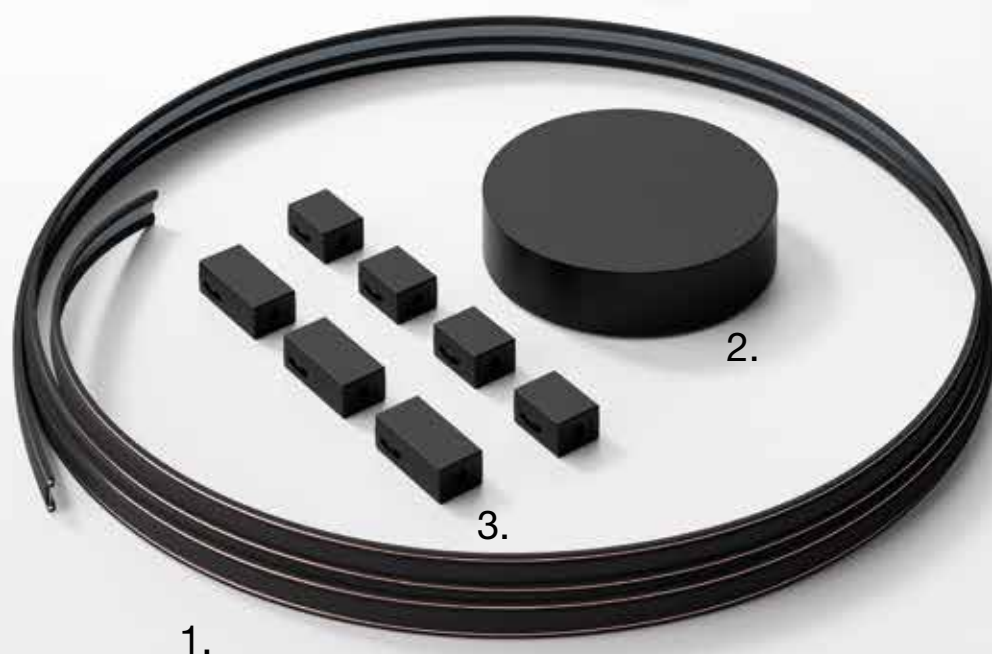

ABACO STAND ALONE KIT

1. 5 m track
thermoplastic elastomer
co-extruded with
copper conductors
20 x 5 mm

Harmonic steel
9 x 1 mm
2. Power supply kit alternatives*
Undimmable
Dimmable 0-10/PUSH/DALI2
(broadcast dimming)
Power: 60W
Ø175 mm
3. 4 x Track support 60
29 x 60 x 20 mm
4. 5 x Track support 40
29 x 40 x 20 mm

*For APP dimming (broadcast), use the remote BLL interface in combinations with 0-10/PUSH/DALI2 version.

Lighting appliances must be ordered separately.

Endless configurations, ranging from the minimum to the maximum extension.

SOME EXAMPLES OF POSSIBLE WALL AND CEILING LAYOUTS

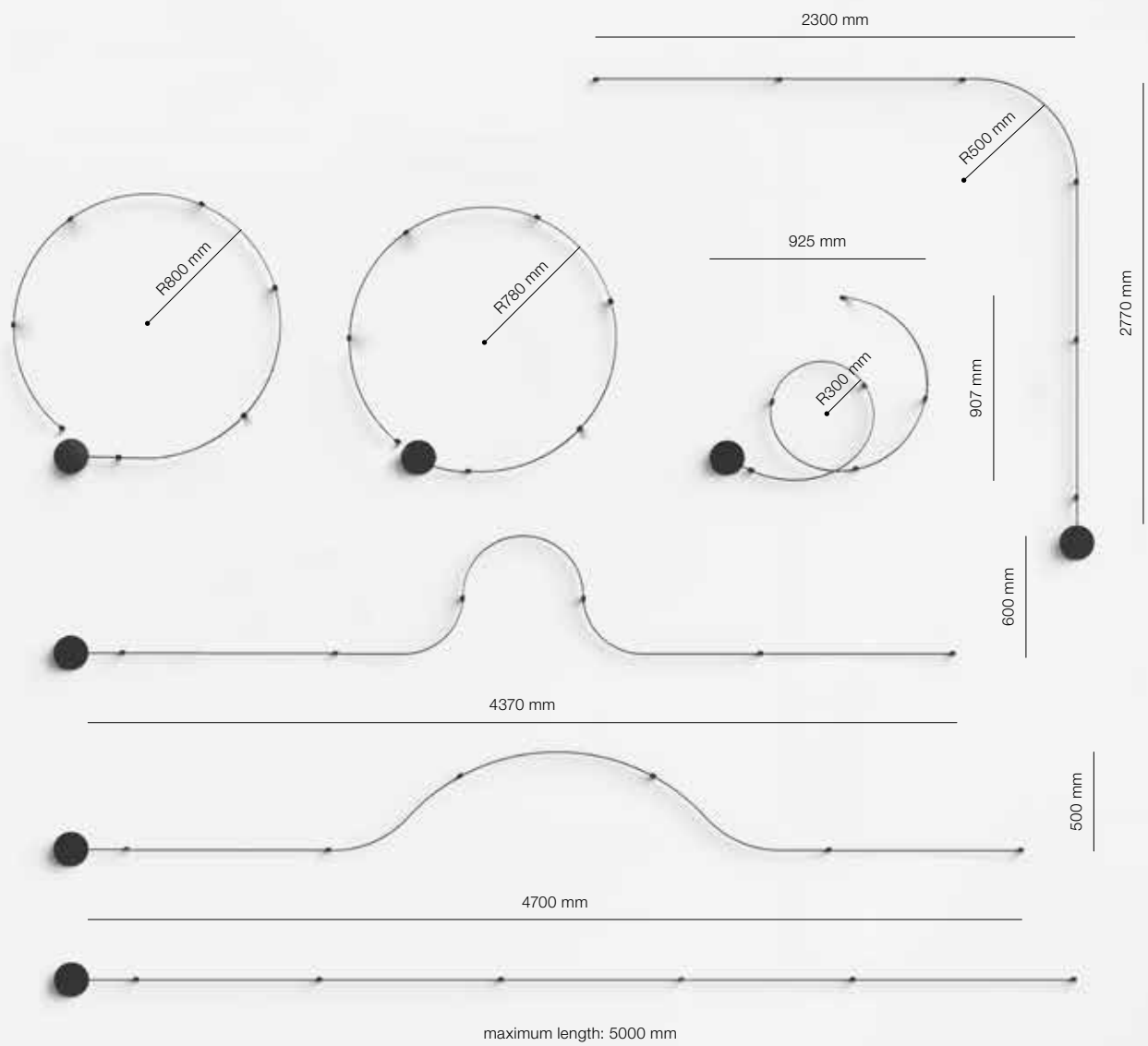

SYLT STAND ALONE

Black



04

Cuttable on-site.
Lighting appliances to be ordered separately.
To properly operate, n.2 lighting appliances are needed for dimmable configurations.
¹Lighting appliances are not individually addressable (broadcast dimming).

IP20



Kit stand alone

Dimming	Power	Code
Undimmable	60W	CH04000
0-10/PUSH/DALI2¹	60W	CH04100

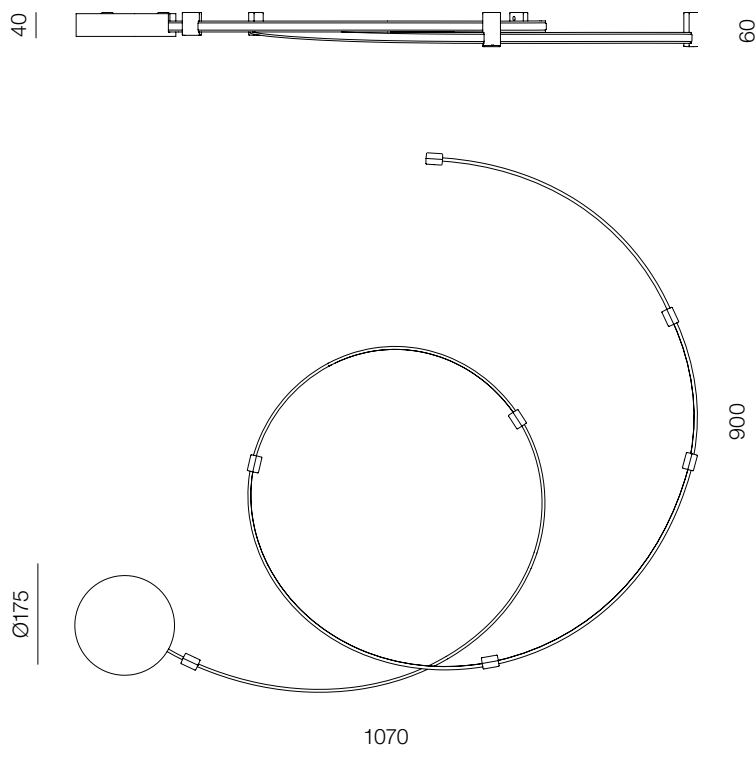

W	Output max	Driver type	N. of power supply kits under same MCB 16A	Supply voltage	Output voltage	Class	Ø _{mm}	H _{mm}
60W	50W	N/D	B: 25 C: 40 D: 75	110 - 277V	48Vdc	⊕	175	40
60W	50W	0-10/PUSH/DALI2*	B: 25 C: 40 D: 75	110 - 277V	48V Intelligence	⊕	175	40

Accessories



Remote BLL interface for Artemide App to manage dimmable modules (up to 40 addresses)
IP20 ⊕
318x176x66h mm

Colour



Code

DV1054APP





Sylt stand alone lighting appliances

FOR CEILING AND WALL INSTALLATION



Helgoland 90
Carlotta de Bevilacqua
Ø90 x 13 mm
Total Power: 6,5W

Helgoland 120
Carlotta de Bevilacqua
Ø120 x 13 mm
Total Power: 9W

(see pg. 26-27)



Vector 30
Carlotta de Bevilacqua
Ø30 x h 77 mm
Total Power: 7W

Vector 40
Carlotta de Bevilacqua
Ø40 x h 103 mm
Total Power: 10W

(see pg. 28-29)

FOR CEILING INSTALLATION ONLY



Linea 25
BIG - Bjarke Ingels
Group
Ø25 x 2500 mm
Total Power: 29W

(see pg. 30-31)



Gople Mini
BIG - Bjarke Ingels Group
Ø145 x h 294 mm
Suspension cable length:
max 1200 mm
Total Power: 9W

(see pg. 34-35)



Diffused linear 600
Carlotta de Bevilacqua
599 x 29 x 20 mm
Total Power: 15W

Diffused linear 1200
Carlotta de Bevilacqua
1187 x 29 x 20 mm
Total Power: 30W

(see pg. 32-33)



Sphere 9
Carlotta de Bevilacqua
Ø90 x h 119 mm
Suspension cable length:
max 1200 mm
Total Power: 4W

Sphere 14
Carlotta de Bevilacqua
Ø140 x h 166 mm
Suspension cable length:
max 1200 mm
Total Power: 9W

(see pg. 36-37)



Unterlinden
Herzog & de Meuron
Ø117 x h 97 mm
Suspension cable length:
max 1200 mm
Total Power: 7W

(see pg. 38-39)





Sylt is compatible with Artemide App

Artemide App is a user-friendly and intuitive interface used to control individual products, groups of appliances and lighting scenarios. It is a tool that can be associated with several products from both the Design and the Architectural Catalogues.

🔍 Find the APP final code in our products.





Download Artemide App
and find more information on
[artemide.com](https://www.artemide.com)

Headquarters

Artemide S.p.A.
Via Bergamo, 18
20006 Pregnana Milanese (MI), Italy
Tel. +39 02 93518.1
Tel. +39 02 93526.1
Numero verde 800 834 093
(from Italy only)
info@artemide.com
artemide.com

Artemide S.p.A.
si riserva la facoltà di modificare, in qualunque momento e senza preavviso, le caratteristiche tecniche degli elementi illustrati nel presente catalogo.

Artemide S.p.A.
reserves the right to change, at any time and without prior warning, the technical specifications of any product illustrated in this catalogue.

Artemide S.p.A.
se réserve le droit de modifier, à n'importe quel moment et sans préavis, les caractéristiques techniques des éléments illustrés dans ce catalogue.

Artemide S.p.A.
behält sich das Recht vor jederzeit und ohne Ankündigung die technischen Daten der im Katalog abgebildeten Produkte zu ändern.

Artemide S.p.A.
se reserva la facultad de modificar, en cualquier y sin aviso previo, las características técnicas de los elementos ilustrados en el presente catálogo.

V.1 2026

For information regarding distributors and points of sale, please visit our website artemide.com or email: info@artemide.com

