



# Turn Around family

Carlotta de Bevilacqua

**Artemide**<sup>®</sup>

# Turn Around

Carlotta de Bevilacqua  
2019

Turn Around inverts the approach to the light system, starting from the principles of sustainability, reduction, lightness, integration, optoelectronic intelligence, application freedom and interaction.

It is a combination of different structural and lighting solutions that adapt to last-minute space thanks to its minimal section.

It is a composition based on a very small track, with a patented section dictated by the standard thickness of plasterboard, meaning it can be inserted into the available space in any situation.

Various linear, 90° angle and curved modules can be combined with electrical and mechanical continuity, availing of the utmost freedom to create every different shapes.

**PATENT OF INVENTION: ELECTRO-MECHANICAL SECTION**  
**PATENT OF INVENTION: SHARP**

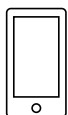

ARTEMIDE  
APP



For further information on Turn Around  
visit [artemide.com](http://artemide.com)



# Turn Around is an innovative system

The freedom to design light in space is ensured by the flexibility to combine different geometries within the structure and also by the possibility to integrate different performances.

Indeed, the same track can accommodate a linear module for diffused light, plus sharpening, spot and suspension modules.

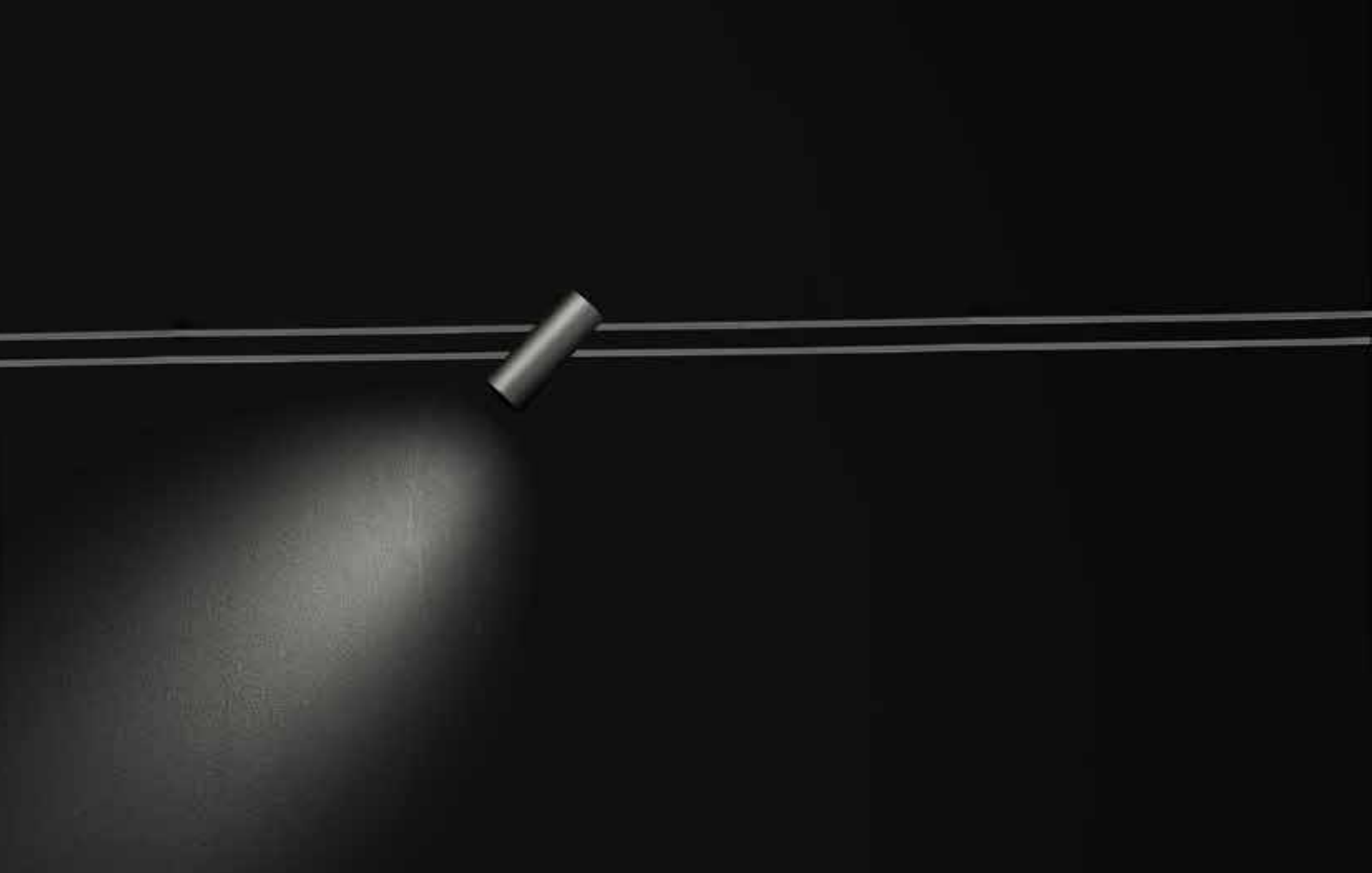

A spotlight is mounted on a track, casting a bright, circular beam of light onto a dark, reflective surface below. The background is dark, and the light creates a strong contrast and a soft glow on the surface.

# Turn Around is extremely flexible

Geometrical flexibility

Performance flexibility

Management flexibility

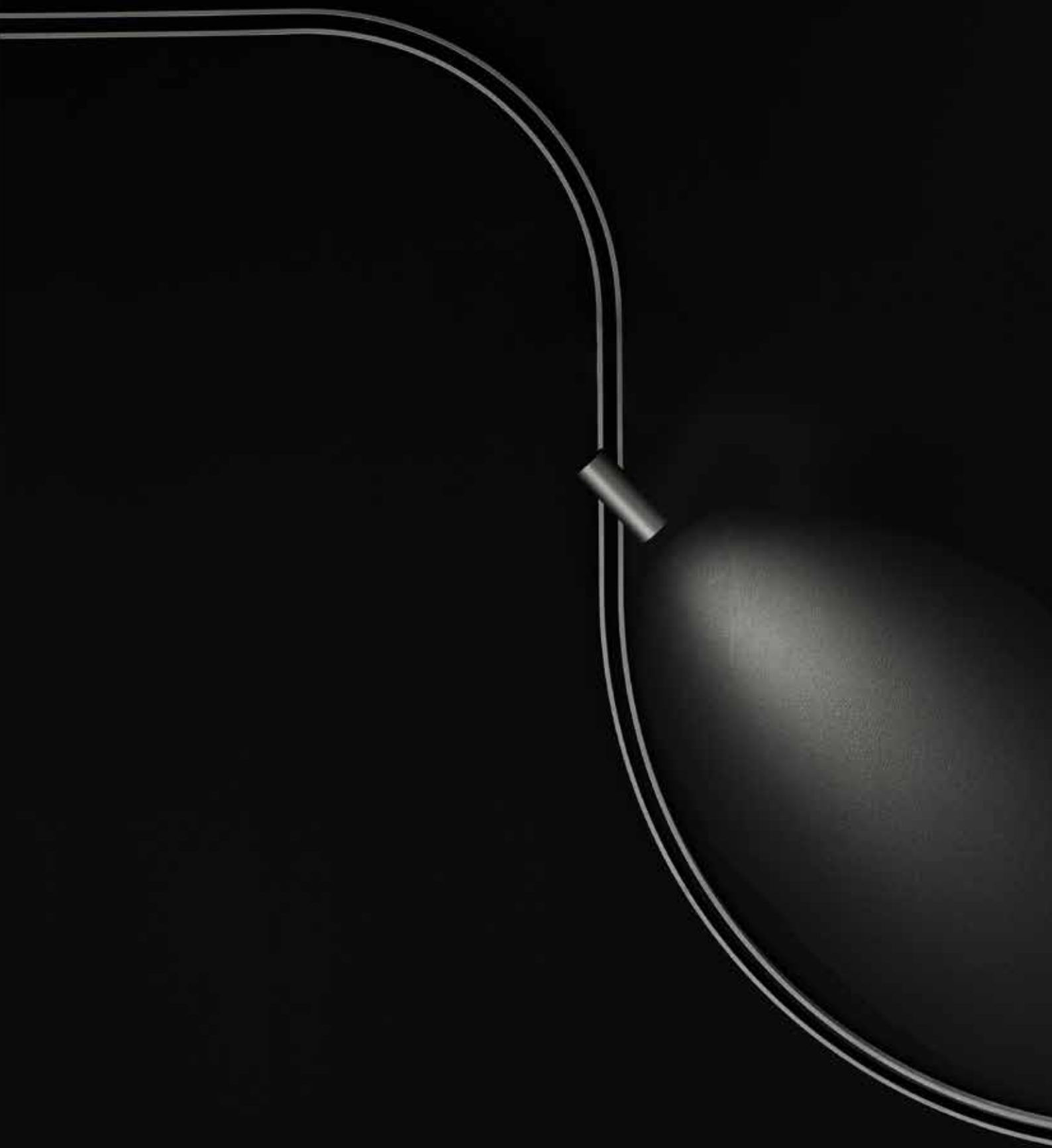

# Reduce to innovate

## **Energetic Infrastructure**

A single continuous energetic infrastructure that accommodates various light performances.

## **48V**

Powered at 48V, there are no practical length limits of the system but only of installed power.

## **Electronic Bridge**

An “invisible” joint permits to transfer power and D.Art from one section to the following, allowing the possibility to insert endless diffused flexible modules.

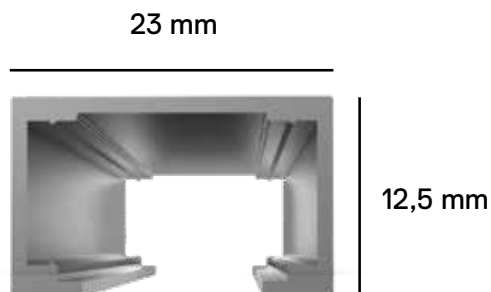



# Asserting one's spatial freedom

Challenging the fundamental sustainability

## h 12.5 x 23 mm for recessed version

Profile dimensions can be integrated into the standard plasterboard thickness without interfering with the structural warping.

## Recessed / SMD / suspension

The profile is integrated into the space in the built-in, ceiling and suspension versions.

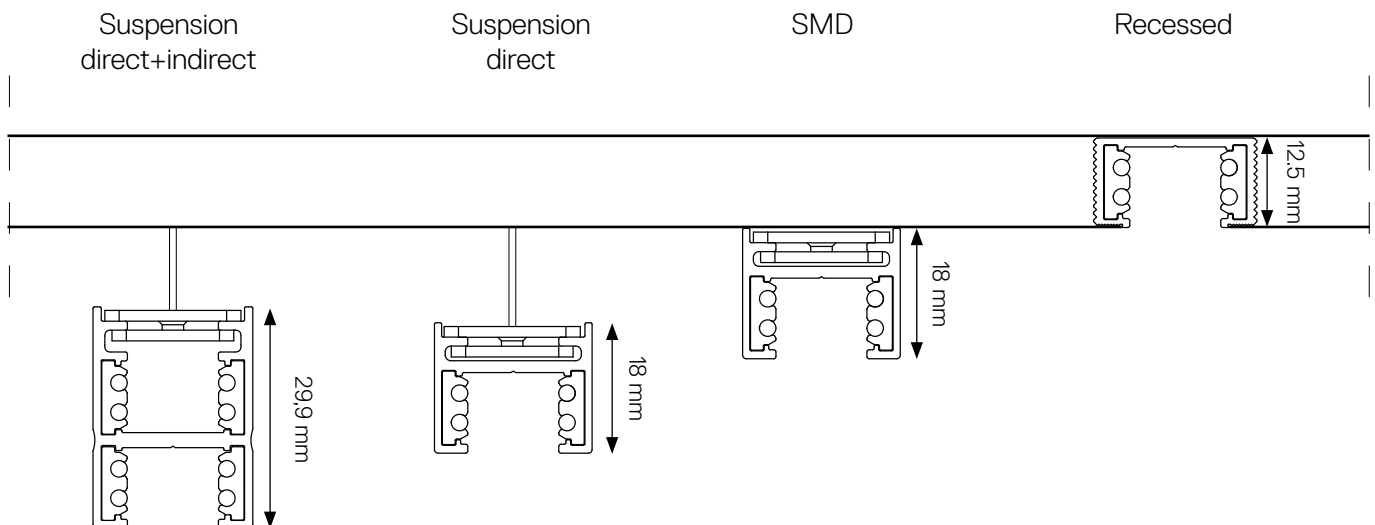

False ceiling scheme

Structural warping

Structural warping

Plasterboard - 12.5 mm thickness

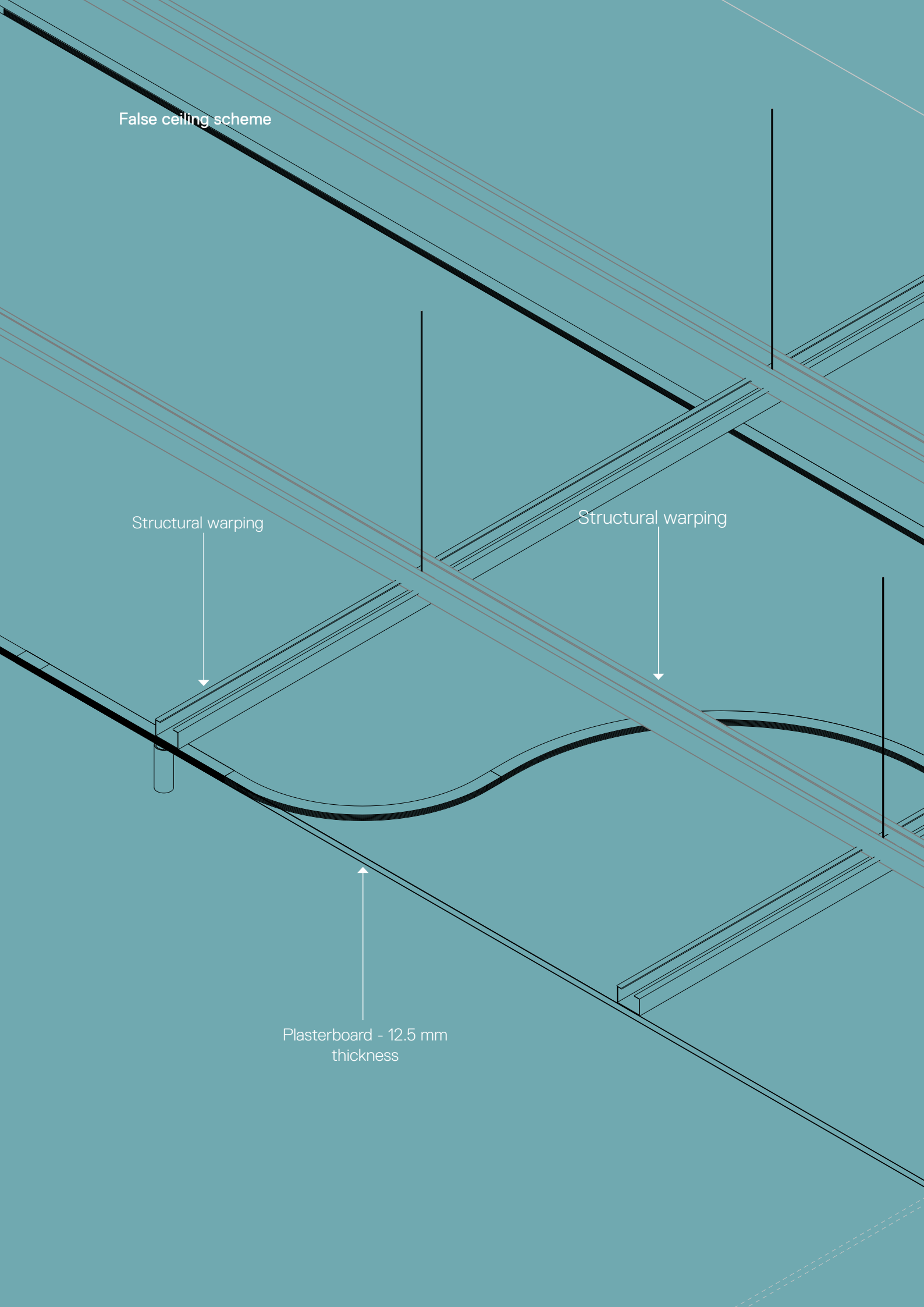

# Turn Around infrastructure

Integrating different performances

## Track 48V

23 x h 12,5 mm (Recessed)

22 x h 18 mm (SMD, suspension direct)

22 x h 31 mm (Suspension direct+indirect)

1000 / 2000 / 3000 mm

- Black (Recessed)
- Titanium (SMD, Suspension)

## Angular and curved elements

### Curves: 90°

Rays: 700 mm, 470 mm, 270 mm

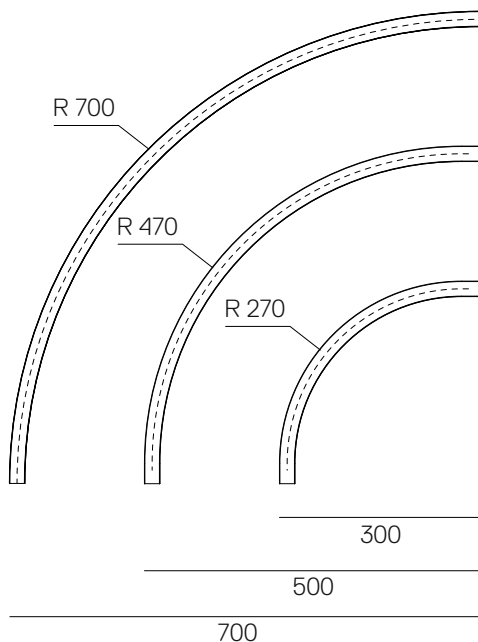

### Curves: 60°

Rays: 700 mm, 470 mm, 270 mm

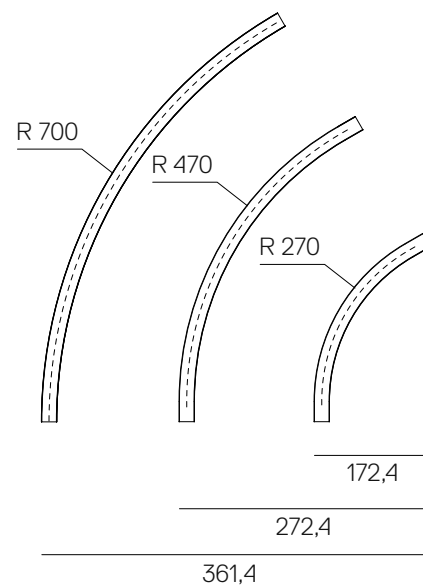

### Linear elements recessed

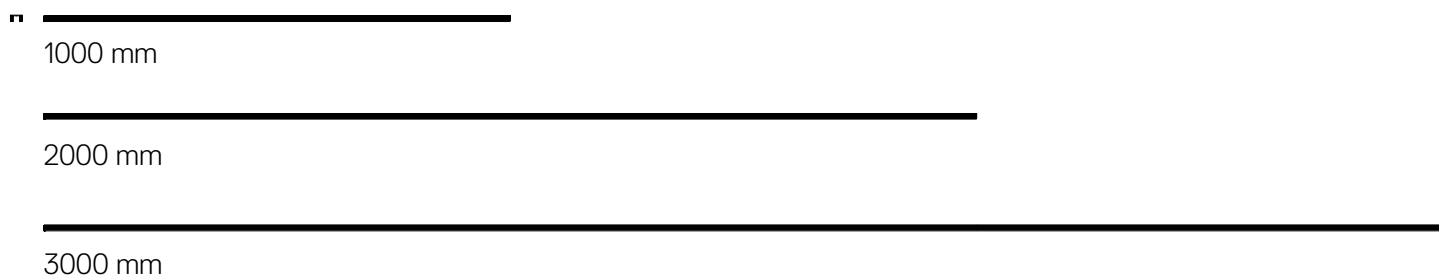

### Linear elements SMD - Suspension direct emission

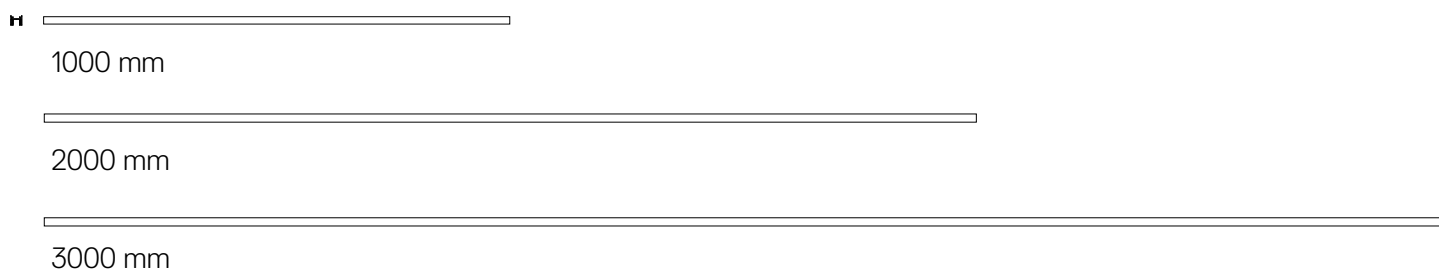

### Linear elements suspension direct + indirect emission

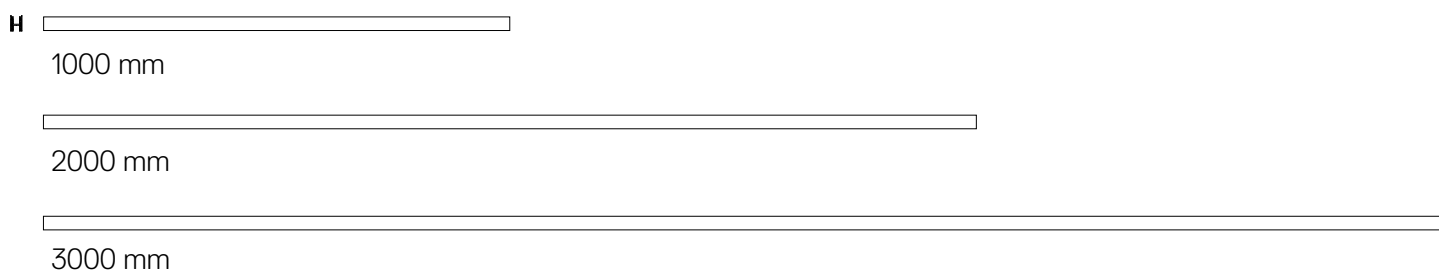

### Curves: 45°

Rays: 700 mm, 470 mm, 270 mm

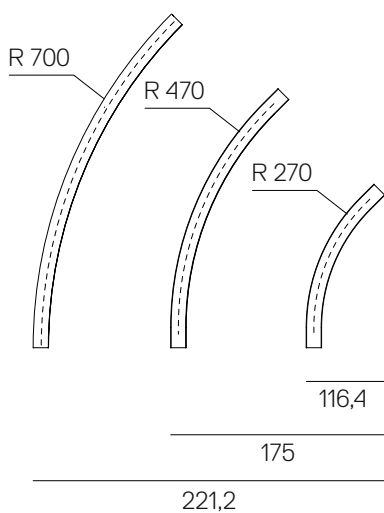

### 90° Angle

same plane recessed

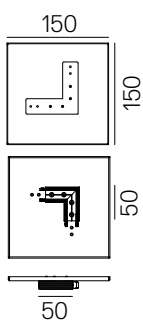

### 90° Angle

same plane suspension direct emission and SMD

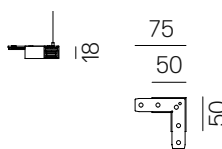

### 90° Angle

same plane suspension direct + indirect emission

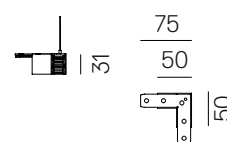

# One body for all the light appliances



Vector

Vector pendant

Square

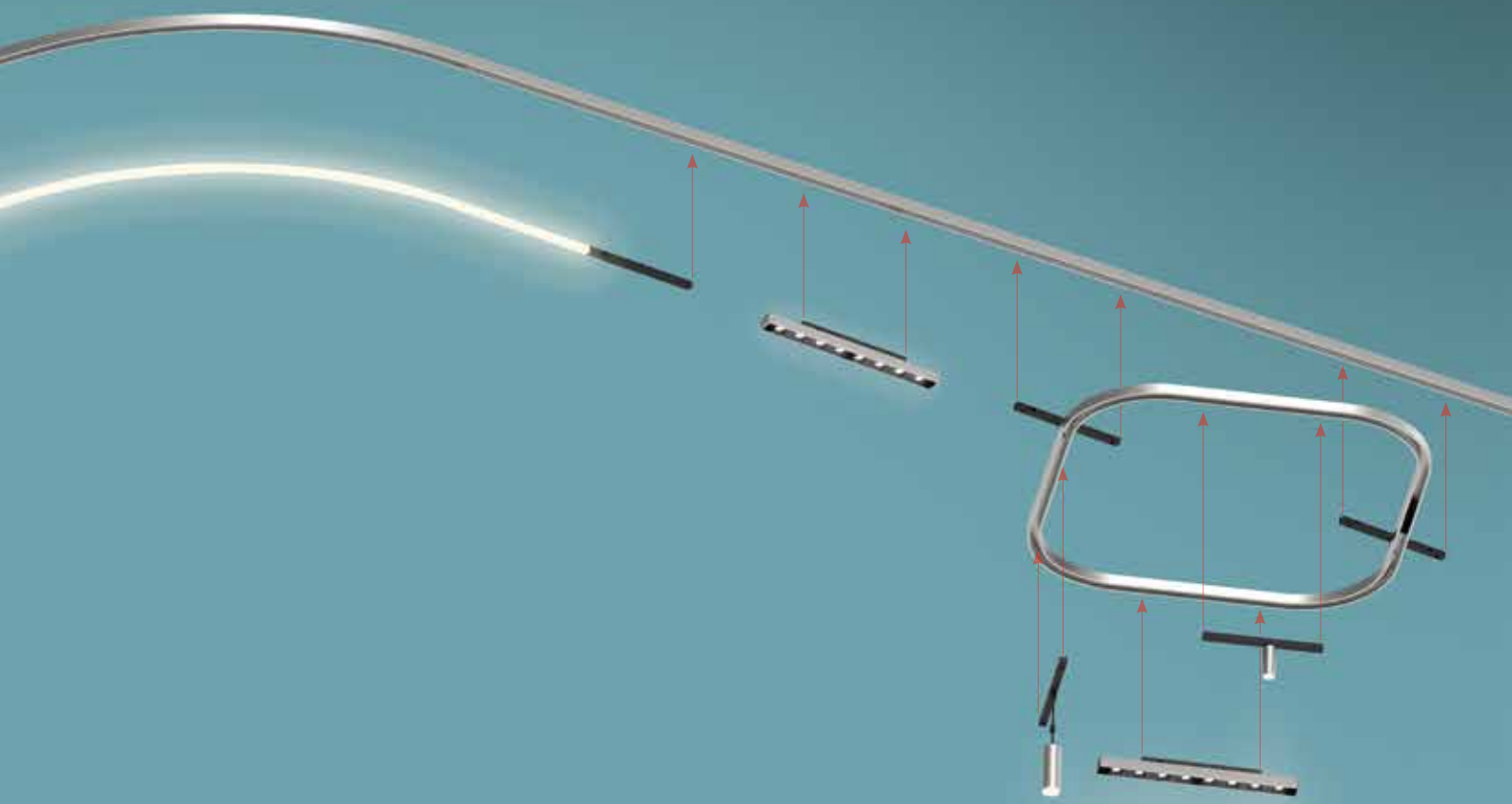

Diffused flexible module

Sharp or diffused  
linear module

Square track  
+ Vector  
+ Vector pendant  
+ Sharp

# Turn Around light appliances

Integrating different performances

## Diffused flexible module

15 x h 10 mm  
540 lm/m installed  
9W/m  
3000K  
Max length 4,5 m

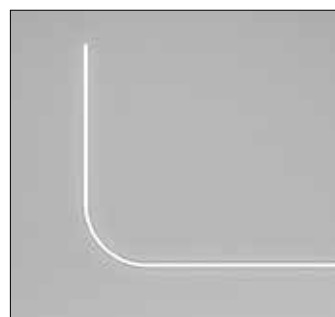
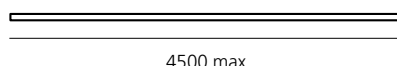

## Vector 30 pendant

Ø 30 x h 77 mm  
335 lm\* - 7W

## Vector 40 pendant

Ø 40 x h 103 mm  
584 lm\* - 10W

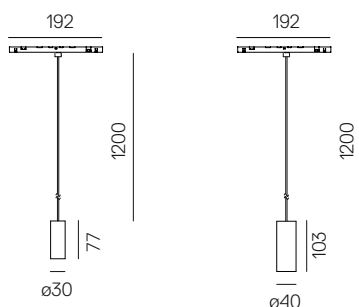

## Vector 20

Ø 20 x h 50 mm  
180 lm\* - 3,5W

## Vector 30

Ø 30 x h 77 mm  
335 lm\* - 7W

## Vector 40

Ø 40 x h 103 mm  
584 lm\* - 10W

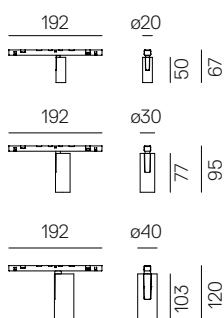

## Sharp 8

316 x 27 x h 20 mm  
1071 lm\* - 14W

## Sharp 12

464 x 27 x h 20 mm  
1607 lm\* - 19W

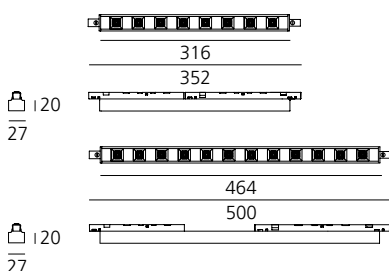

\* 3000K values

**Diffused linear module 600**

599 x 27 x h 20 mm

1421 lm\* - 15W

**Diffused linear module 1200**

1187 x 27 x h 20 mm

2843 lm\* - 30W

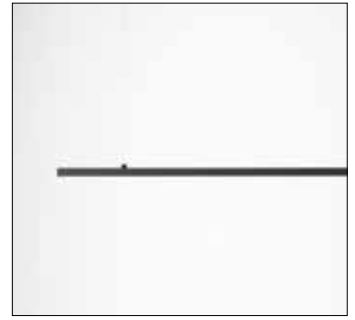
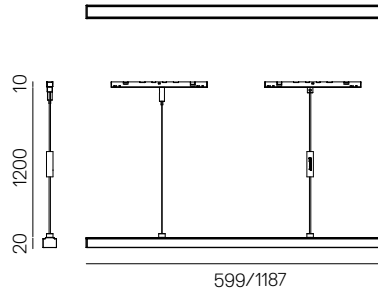

**Horizontal square track**

590 x 590 x h 17,5 mm

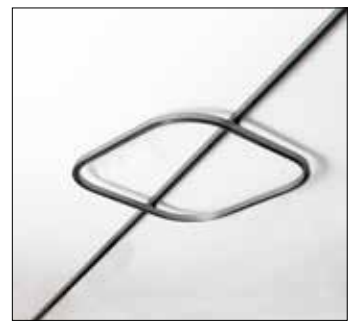
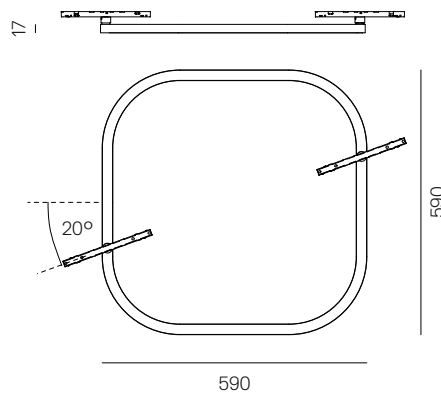

**Horizontal square diffused Strip LED**

Diffused emission

590 x 590 x h 17,5 mm

1001 lm - 18W

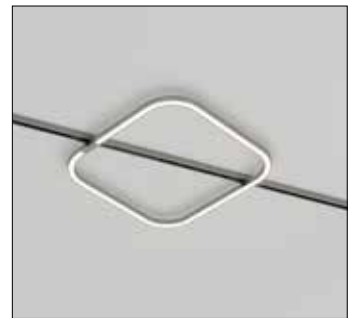
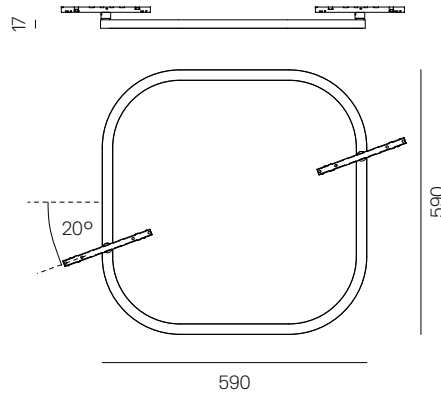

**Vertical Square diffused Strip LED**

Diffused emission

590 x 590 x h 17,5 mm

976 lm\* - 18W

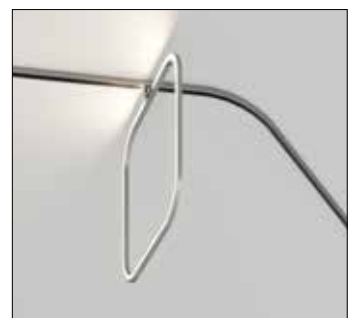
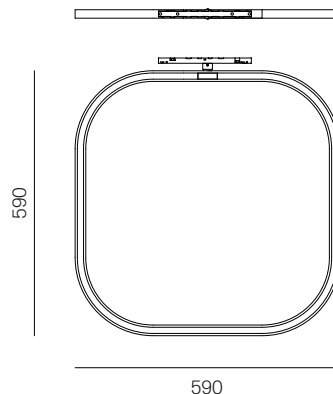

\* 3000K values

# Turn Around is powered at 48 Vdc

## ELEVATION

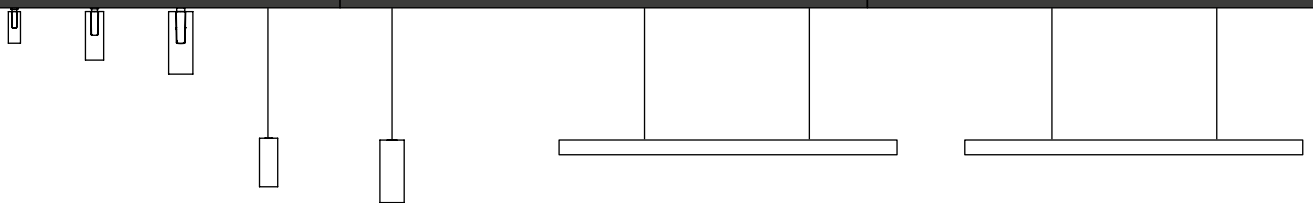

### VECTOR 20

max 35 with 1 Power supply 150W  
max 60 with 1 Power supply 240W  
max 77 with 1 Power supply 320W

### VECTOR 30/VECTOR 30 PENDANT

max 17 with 1 Power supply 150W  
max 30 with 1 Power supply 240W  
max 38 with 1 Power supply 320W

### VECTOR 40/VECTOR 40 PENDANT

max 12 with 1 Power supply 150W  
max 21 with 1 Power supply 240W  
max 27 with 1 Power supply 320W

### DIFFUSED LINEAR MODULE 600

max 8 with 1 Power supply 150W  
max 14 with 1 Power supply 240W  
max 18 with 1 Power supply 320W

### DIFFUSED LINEAR MODULE 1200

max 4 with 1 Power supply 150W  
max 7 with 1 Power supply 240W  
max 9 with 1 Power supply 320W

### SHARP 8

max 8 with 1 Power supply 150W  
max 15 with 1 Power supply 240W  
max 19 with 1 Power supply 320W

### SHARP 12

max 6 with 1 Power supply 150W  
max 11 with 1 Power supply 240W  
max 14 with 1 Power supply 320W

### DIFFUSED

#### FLEXIBLE MODULE 2m

max 7 with 1 Power supply 150W  
max 12 with 1 Power supply 240W  
max 15 with 1 Power supply 320W

#### FLEXIBLE MODULE 4,5m

max 3 with 1 Power supply 150W  
max 5 with 1 Power supply 240W  
max 7 with 1 Power supply 320W

PLAN

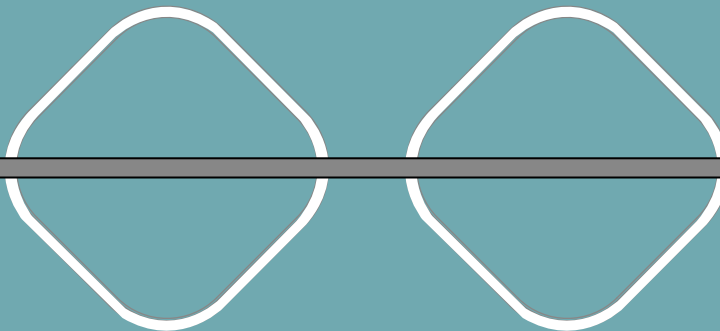

### SQUARE INSETS

VECTOR 20, 30, 40  
max 3

VECTOR PENDANT  
30, 40  
max 3

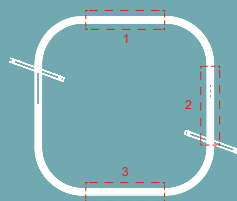

SHARP 8  
max 3





# Turn Around is safe

a unique feature developed for a real  
safe DALI interface.



D.Art is a technology designed by Artemide that overcomes the safety limits of the DALI signal in devices where the same signal is accessible to the touch.

The DALI signal is transformed to a “SELV” safety extra low voltage ensuring the total safety of the appliance.

Turn Around has been designed in compliance with international certifications.



# Asserting electronic intelligence

Reduce to innovate



ARTEMIDE  
APP

## Artemide APP

Real time freedom not only during installation but also in the interaction through Artemide APP that manages the DALI addresses present in the system.



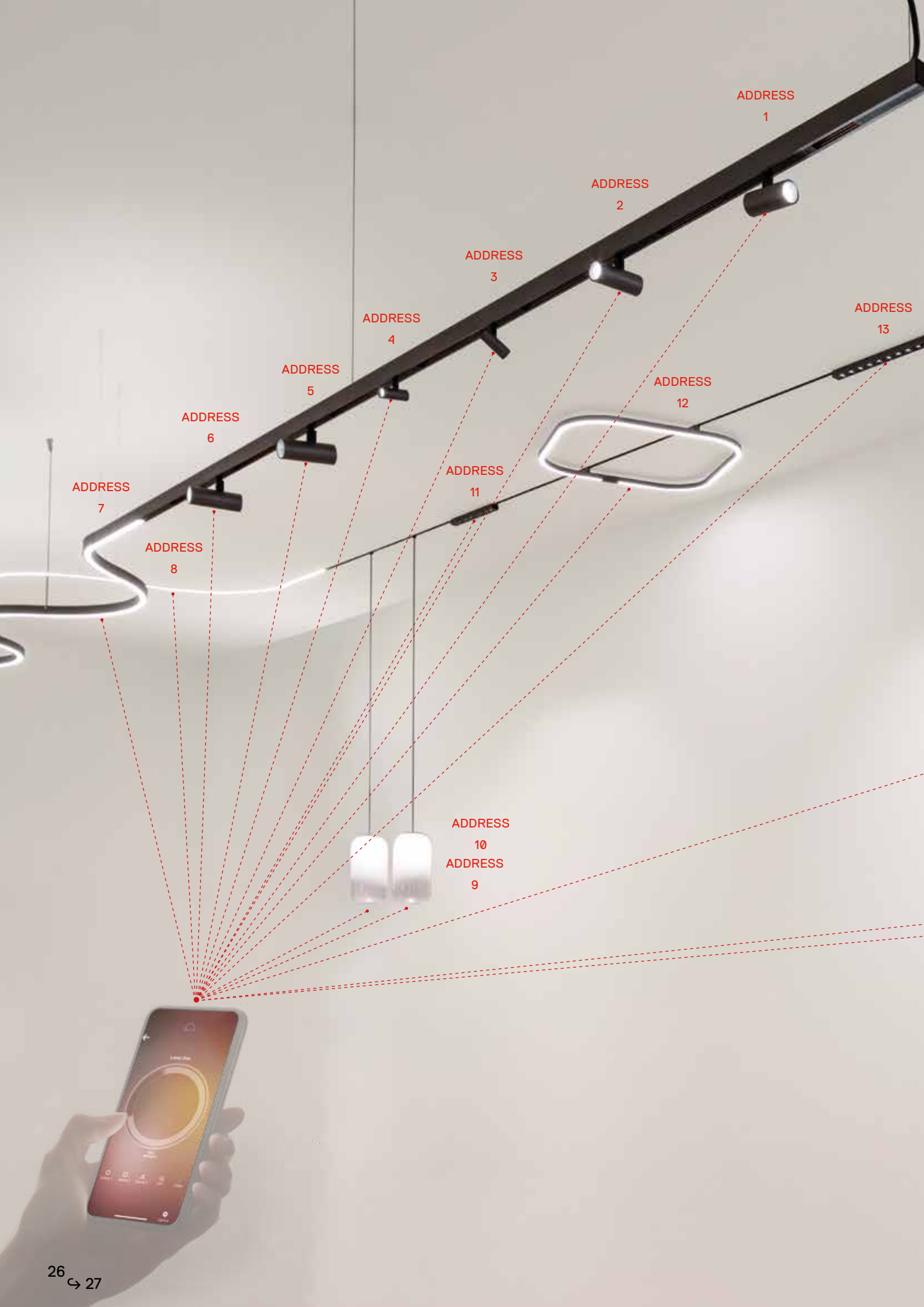



# Turn Around is fully addressable

Each lighting appliance can be managed separately by Artemide APP or by DALI control

# Turn Around power supply

CEILING  
POWER SUPPLY  
240W - 150W

RECESSED  
POWER SUPPLY  
320W - 240W - 150W

REMOTE BARE  
POWER SUPPLY  
240W - 150W

REMOTE BOX  
POWER SUPPLY  
320W - 240W

A

B

C

D

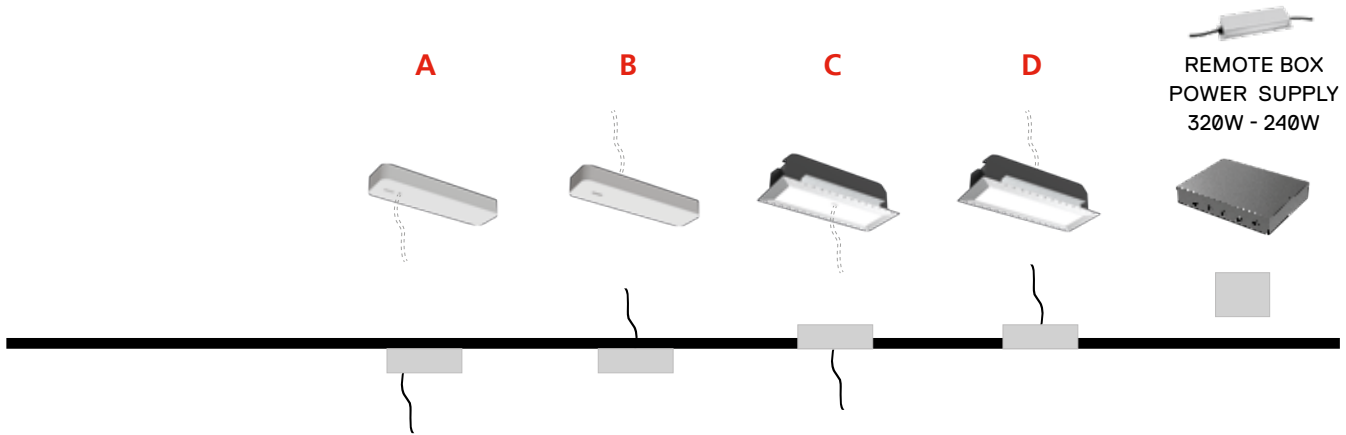

## SUSPENSION

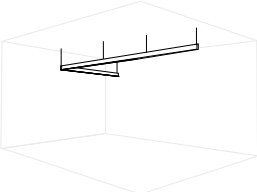
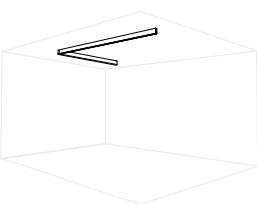
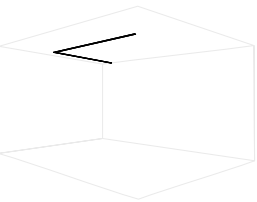
	●		●		●
<b>SMD</b>					
	●	●			●
<b>RECESSED</b>					
		●		●	●

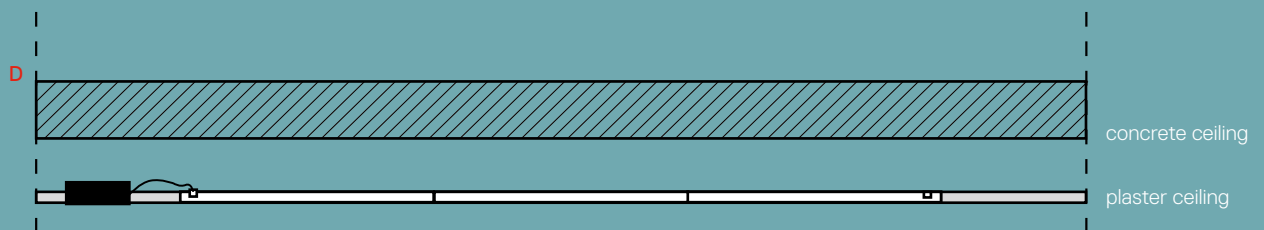
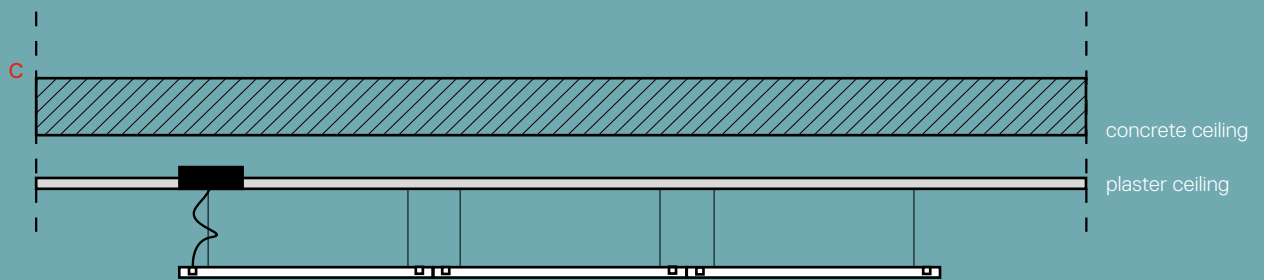
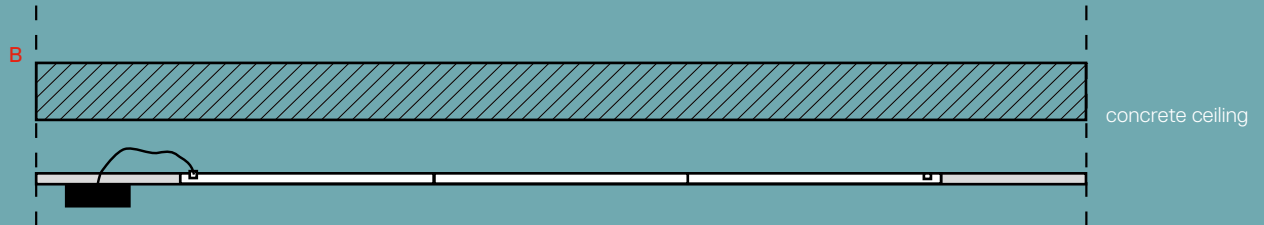
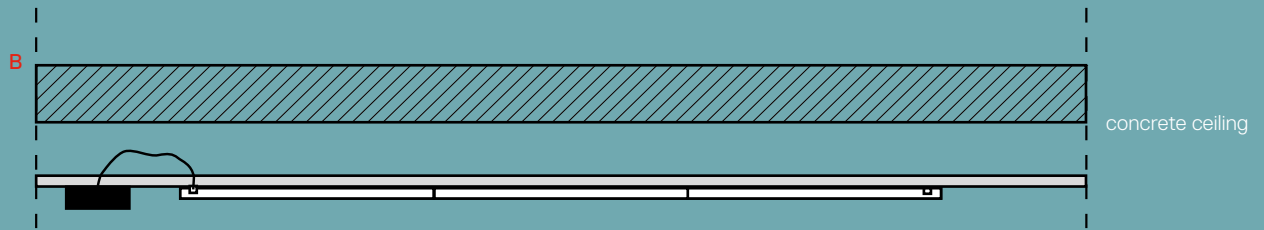
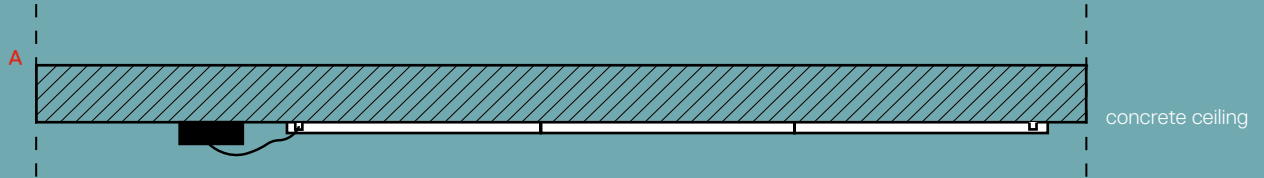
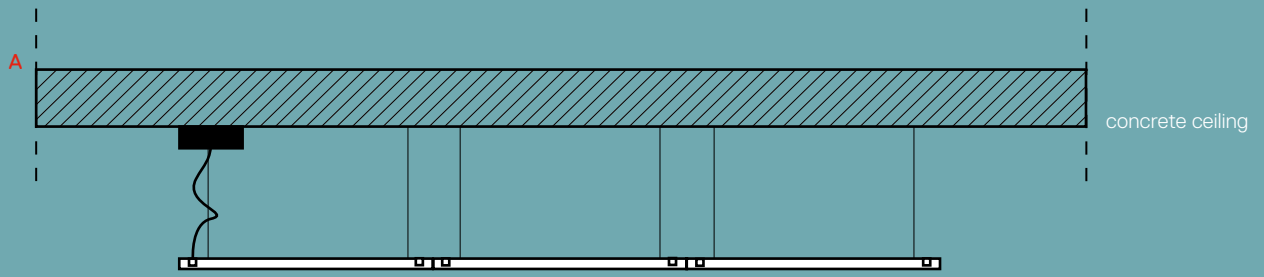

# Turn Around structural track

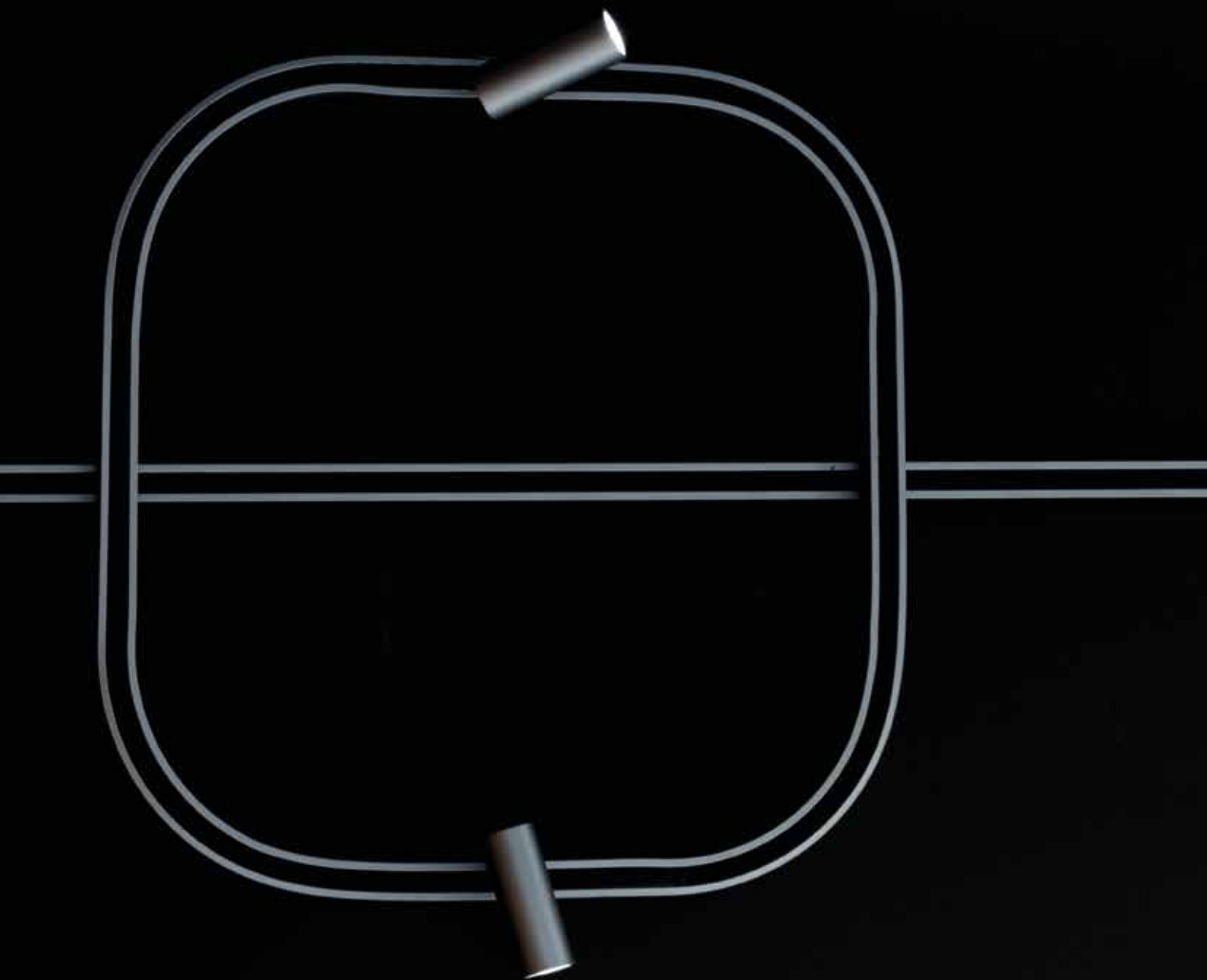

# TURN AROUND RECESSED TRACK

Black



IP20



## Linear elements

### Length

1000 mm  
2000 mm  
3000 mm

### Code

TA00104  
TA00204  
TA00304

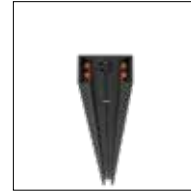

12.5 | 23

## Angle elements

90° on same plane track angle elements  
50 x 50 mm

### Code

TA80004

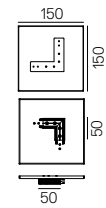
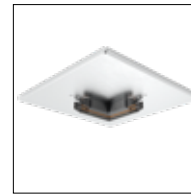

## Curved joining elements

Radius      Angle

300 mm

45°

60°

90°

500 mm

45°

60°

90°

700 mm

45°

60°

90°

### Code

TA30004

TA30304

TA30604

TA30104

TA30404

TA30704

TA30204

TA30504

TA30804

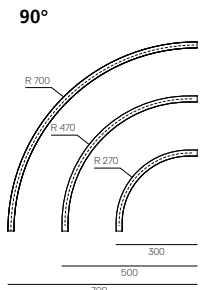
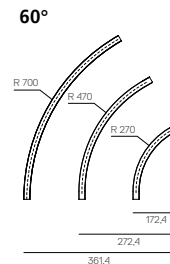
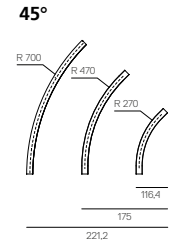
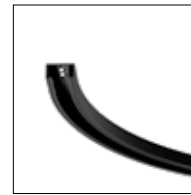

## Accessories



Fed end cap  
Cable L= 2500 mm

### Code

TA90600



Recessed fixing kit (7pcs)  
Linear element L= 3000 mm uses 7pcs  
Linear element L= 2000 mm uses 5pcs  
Linear element L= 1000 mm uses 3pcs

TA90100



Electro-mechanical Joint kit

TA90000

## Accessories for cutting components of linear elements

Shaping tool: to shape insulating conductor support

### Code

TA00000

















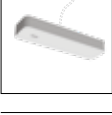

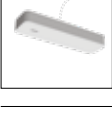
Locking tool: to lock insulating conductor spacer into aluminum profile

TA00100

Note: no tools provided to cut aluminum profile

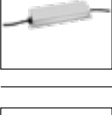
White Titanium

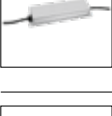

Power supply	Undimmable Code	DALI / 0-10 / 1-10 / PUSH Code	Dimmable APP Code
 <p>320W Recessed power supply kit for recessed modules 230VAC-48VDC IP20  395 x 165 x h 107 mm</p>	TA66001	TA66101	TA66101APP
 <p>240W Recessed power supply kit for recessed modules 230VAC-48VDC IP20  395 x 165 x h 107 mm</p>	TA61901	TA62001	TA62001APP
 <p>150W Recessed power supply kit for recessed modules 230VAC-48VDC IP20  395 x 165 x h 107 mm</p>	TA61701	TA61801	TA61801APP
 <p>240W Ceiling power supply kit for recessed and ceiling modules 230VAC-48VDC IP20  400 x 110 x h 50 mm</p>	<input type="radio"/> TA60501 <input checked="" type="radio"/> TA60722	<input type="radio"/> TA60601 <input checked="" type="radio"/> TA60822	<input type="radio"/> TA60601APP <input checked="" type="radio"/> TA60822APP
 <p>150 W Ceiling power supply kit for recessed and ceiling modules 230VAC-48VDC IP20  400 x 110 x h 50 mm</p>	<input type="radio"/> TA60101 <input checked="" type="radio"/> TA60322	<input type="radio"/> TA60201 <input checked="" type="radio"/> TA60422	<input type="radio"/> TA60201APP <input checked="" type="radio"/> TA60422APP
 <p>320W Remote box power supply kit 230VAC-48VDC IP20  313 x 243 x h 57,5 mm</p>		TA68000	TA68000APP
 <p>240W Remote box power supply kit 230VAC-48VDC IP20  313 x 243 x h 57,5 mm</p>		TA62500	TA62500APP
 <p>240W Bare power supply <b>ON-OFF</b> 230VAC-48VDC IP20  (for dimmable version to be combined with "DV1061") 244 x 68 x h 38 mm</p>	TA98000		
 <p>150W Bare power supply <b>ON-OFF</b> 230VAC-48VDC IP20  (for dimmable version to be combined with "DV1061") 244 x 68 x h 38 mm</p>	TA98100		
 <p><b>DALI / 0-10 / 1-10 / PUSH</b> SELV Interface 103 x 67 x h 21 mm</p>		DV1061	

#### Optional control devices - BLL wireless switch



Device for switching and controlling Artemide APP products.  
Max N.3 inputs for external push buttons.  
Max 1 m distance.  
Mains power supply required.  
To be installed inside flush mounting boxes or junction boxes.

DV1080APP

# TURN AROUND SMD TRACK

Titanium

IP20



## Linear elements

### Length

1000 mm

2000 mm

3000 mm

### Code

TA10122

TA10222

TA10322

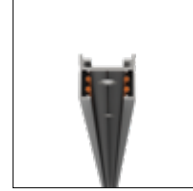

## Angle elements

90° on same plane track angle elements

75 x 75 mm

### Code

TA80122

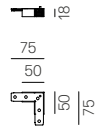

## Curved joining elements

### Radius

300 mm

### Alpha

45°

60°

90°

500 mm

45°

60°

90°

700 mm

45°

60°

90°

### Code

TA40022

TA40322

TA40622

TA40122

TA40422

TA40722

TA40222

TA40522

TA40822

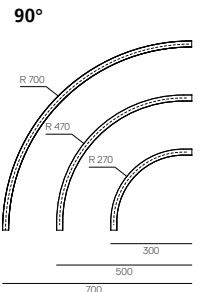
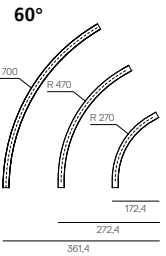
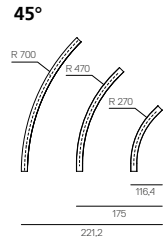

## Accessories



Fed end cap  
Cable L= 2500 mm

### Code

TA90600



Ceiling bracket kit (4pcs)  
Linear element L = 3000 mm uses 4pcs  
Linear element L = 2000 mm uses 3pcs  
Linear element L = 1000 mm uses 1pcs

TA90400

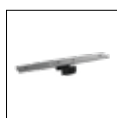









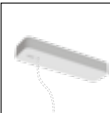

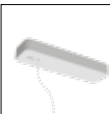



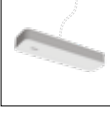

Electro-mechanical joint kit

TA90200

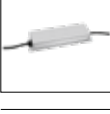
White Titanium



Power supply	Undimmable Code	DALI / 0-10 / 1-10 / PUSH Code	Dimmable APP Code
 <p>240W Ceiling power supply kit for suspension and ceiling modules 230VAC-48VDC IP20  400 x 110 x h 50 mm</p>	<input type="radio"/> TA61301 <input checked="" type="radio"/> TA61522	<input type="radio"/> TA61401 <input checked="" type="radio"/> TA61622	<input type="radio"/> TA61401APP <input checked="" type="radio"/> TA61622APP
 <p>150W Ceiling power supply kit for suspension and ceiling modules 230VAC-48VDC IP20  400 x 110 x h 50 mm</p>	<input type="radio"/> TA60901 <input checked="" type="radio"/> TA61122	<input type="radio"/> TA61001 <input checked="" type="radio"/> TA61222	<input type="radio"/> TA61001APP <input checked="" type="radio"/> TA61222APP
 <p>240W Ceiling power supply kit for recessed and ceiling modules 230VAC-48VDC IP20  400 x 110 x h 50 mm</p>	<input type="radio"/> TA60501 <input checked="" type="radio"/> TA60722	<input type="radio"/> TA60601 <input checked="" type="radio"/> TA60822	<input type="radio"/> TA60601APP <input checked="" type="radio"/> TA60822APP
 <p>150W Ceiling power supply kit for recessed and ceiling modules 230VAC-48VDC IP20  400 x 110 x h 50 mm</p>	<input type="radio"/> TA60101 <input checked="" type="radio"/> TA60322	<input type="radio"/> TA60201 <input checked="" type="radio"/> TA60422	<input type="radio"/> TA60201APP <input checked="" type="radio"/> TA60422APP
 <p>320W Remote box power supply kit 230VAC-48VDC IP20  313 x 243 x h 57,5 mm</p>		TA68000	TA68000APP
 <p>240W Remote box power supply kit 230VAC-48VDC IP20  313 x 243 x h 57,5 mm</p>		TA62500	TA62500APP
 <p>240W Bare power supply <b>ON-OFF</b> 230VAC-48VDC IP20  (for dimmable version to be combined with "DV1061") 244 x 68 x h 38 mm</p>	TA98000		
 <p>150W Bare power supply <b>ON-OFF</b> 230VAC-48VDC IP20  (for dimmable version to be combined with "DV1061") 244 x 68 x h 38 mm</p>	TA98100		
 <p><b>DALI / 0-10 / 1-10 / PUSH</b> SELV Interface 103 x 67 x h 21 mm</p>		DV1061	

#### Optional control devices - BLL wireless switch

 <p>Device for switching and controlling Artemide APP products. Max N.3 inputs for external push buttons. Max 1 m distance. Mains power supply required. To be installed inside flush mounting boxes or junction boxes.</p>	DV1080APP
--	-----------

# TURN AROUND SUSPENSION DIRECT TRACK

Titanium

IP20



## Linear elements

### Length

1000 mm  
2000 mm  
3000 mm

### Code

TA10122  
TA10222  
TA10322

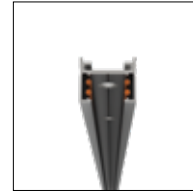

## Angle elements

90° on same plane track angle elements  
75 x 75 mm

### Code

TA80122

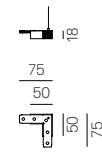

## Curved joining elements

Radius Alpha

300 mm

45°

60°

90°

500 mm

45°

60°

90°

700 mm

45°

60°

90°

### Code

TA40022

TA40322

TA40622

TA40122

TA40422

TA40722

TA40222

TA40522

TA40822

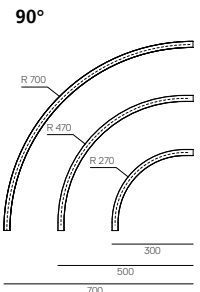
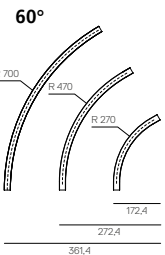
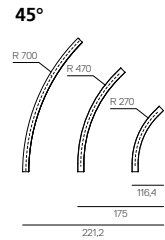

## Accessories



Fed end cap  
Cable L= 2500 mm

### Code

TA90600



Suspension kit (3pcs)  
Linear element L= 3000 mm uses 3pcs  
Linear element L= 2000 mm uses 2pcs  
Linear element L= 1000 mm uses 2pcs

TA90500

















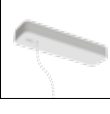

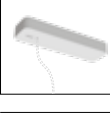

Electro-mechanical joint kit

TA90300

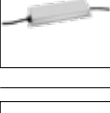
White Titanium

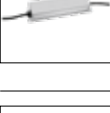

Power supply	Undimmable Code	DALI / 0-10 / 1-10 / PUSH Code	Dimmable APP Code
 <p>320W Recessed power supply kit for suspension modules 230VAC-48VDC IP20 </p> <p>395 x 165 x h 107 mm</p>	TA67001	TA67101	TA67101APP
 <p>240W Recessed power supply kit for suspension modules 230VAC-48VDC IP20 </p> <p>395 x 165 x h 107 mm</p>	TA62301	TA62401	TA62401APP
 <p>150W Recessed power supply kit for suspension modules 230VAC-48VDC IP20 </p> <p>395 x 165 x h 107 mm</p>	TA62101	TA62201	TA62201APP
 <p>240W Ceiling power supply kit for suspension and ceiling modules 230VAC-48VDC IP20 </p> <p>400 x 110 x h 50 mm</p>	<input type="radio"/> TA61301 <input checked="" type="radio"/> TA61522	<input type="radio"/> TA61401 <input checked="" type="radio"/> TA61622	<input type="radio"/> TA61401APP <input checked="" type="radio"/> TA61622APP
 <p>150W Ceiling power supply kit for suspension and ceiling modules 230VAC-48VDC IP20 </p> <p>400 x 110 x h 50 mm</p>	<input type="radio"/> TA60901 <input checked="" type="radio"/> TA61122	<input type="radio"/> TA61001 <input checked="" type="radio"/> TA61222	<input type="radio"/> TA61001APP <input checked="" type="radio"/> TA61222APP
 <p>320W Remote box power supply kit 230VAC-48VDC IP20 </p> <p>313 x 243 x h 57,5 mm</p>		TA68000	TA68000APP
 <p>240W Remote box power supply kit 230VAC-48VDC IP20 </p> <p>313 x 243 x h 57,5 mm</p>		TA62500	TA62500APP
 <p>240W Bare power supply <b>ON-OFF</b> 230VAC-48VDC IP20  (for dimmable version to be combined with "DV1061") 244 x 68 x h 38 mm</p>	TA98000		
 <p>150W Bare power supply <b>ON-OFF</b> 230VAC-48VDC IP20  (for dimmable version to be combined with "DV1061") 244 x 68 x h 38 mm</p>	TA98100		
 <p><b>DALI / 0-10 / 1-10 / PUSH</b> SELV Interface 103 x 67 x h 21 mm</p>		DV1061	

#### Optional control devices - BLL wireless switch

 <p>Device for switching and controlling Artemide APP products. Max N.3 inputs for external push buttons. Max 1 m distance. Mains power supply required. To be installed inside flush mounting boxes or junction boxes.</p>	DV1080APP
--	-----------

# TURN AROUND SUSPENSION DIRECT+INDIRECT TRACK

Titanium



\*Delivery time on demand

IP20



## Linear elements

### Length

1000 mm  
2000 mm  
3000 mm

## Direct + Indirect

### Code

TA20122  
TA20222  
TA20322

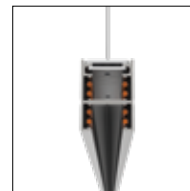

## Angle elements

90° on same plane track angle elements  
75 x 75 mm

## Direct + Indirect

### Code

TA80222

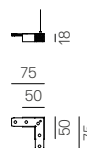

## Curved joining elements\*

### Radius Alpha

300 mm 45°

60°

90°

500 mm 45°

60°

90°

700 mm 45°

60°

90°

## Direct + Indirect

### Code

TA50022

TA50322

TA50622

TA50122

TA50422

TA50722

TA50222

TA50522

TA50822

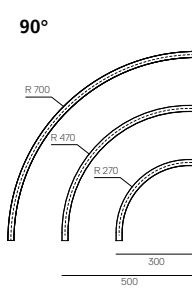
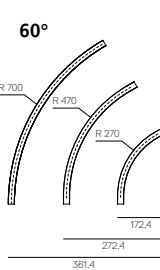
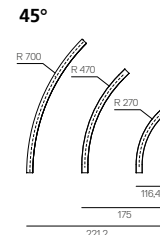

## Accessories



Fed end cap  
Cable L= 2500 mm

### Code

TA90800



Suspension kit (3pcs)  
Linear element L= 3000 mm uses 3pcs  
Linear element L= 2000 mm uses 2pcs  
Linear element L= 1000 mm uses 2pcs

TA90500

















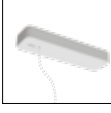

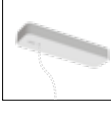

Electro-mechanical joint kit

TA90300

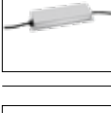
White Titanium



Power supply	Undimmable Code	DALI / 0-10 / 1-10 / PUSH Code	Dimmable APP Code
 <p>320W Recessed power supply kit for suspension modules 230VAC-48VDC IP20  395 x 165 x h 107 mm</p>	TA67001	TA67101	TA67101APP
 <p>240W Recessed power supply kit for suspension modules 230VAC-48VDC IP20  395 x 165 x h 107 mm</p>	TA62301	TA62401	TA62401APP
 <p>150W Recessed power supply kit for suspension modules 230VAC-48VDC IP20  395 x 165 x h 107 mm</p>	TA62101	TA62201	TA62201APP
 <p>240W Ceiling power supply kit for suspension and ceiling modules 230VAC-48VDC IP20  400 x 110 x h 50 mm</p>	<input type="radio"/> TA61301 <input checked="" type="radio"/> TA61522	<input type="radio"/> TA61401 <input checked="" type="radio"/> TA61622	<input type="radio"/> TA61401APP <input checked="" type="radio"/> TA61622APP
 <p>150W Ceiling power supply kit for suspension and ceiling modules 230VAC-48VDC IP20  400 x 110 x h 50 mm</p>	<input type="radio"/> TA60901 <input checked="" type="radio"/> TA61122	<input type="radio"/> TA61001 <input checked="" type="radio"/> TA61222	<input type="radio"/> TA61001APP <input checked="" type="radio"/> TA61222APP
 <p>320W Remote box power supply kit 230VAC-48VDC IP20  313 x 243 x h 57,5 mm</p>		TA68000	TA68000APP
 <p>240W Remote box power supply kit 230VAC-48VDC IP20  313 x 243 x h 57,5 mm</p>		TA62500	TA62500APP
 <p>240W Bare power supply ON-OFF 230VAC-48VDC IP20  (for dimmable version to be combined with "DV1061") 244 x 68 x h 38 mm</p>	TA98000		
 <p>150W Bare power supply ON-OFF 230VAC-48VDC IP20  (for dimmable version to be combined with "DV1061") 244 x 68 x h 38 mm</p>	TA98100		
 <p>DALI / 0-10 / 1-10 / PUSH SELV Interface 103 x 67 x h 21 mm</p>		DV1061	

#### Optional control devices - BLL wireless switch

 <p>Device for switching and controlling Artemide APP products. Max N.3 inputs for external push buttons. Max 1 m distance. Mains power supply required. To be installed inside flush mounting boxes or junction boxes.</p>	DV1080APP
--	-----------

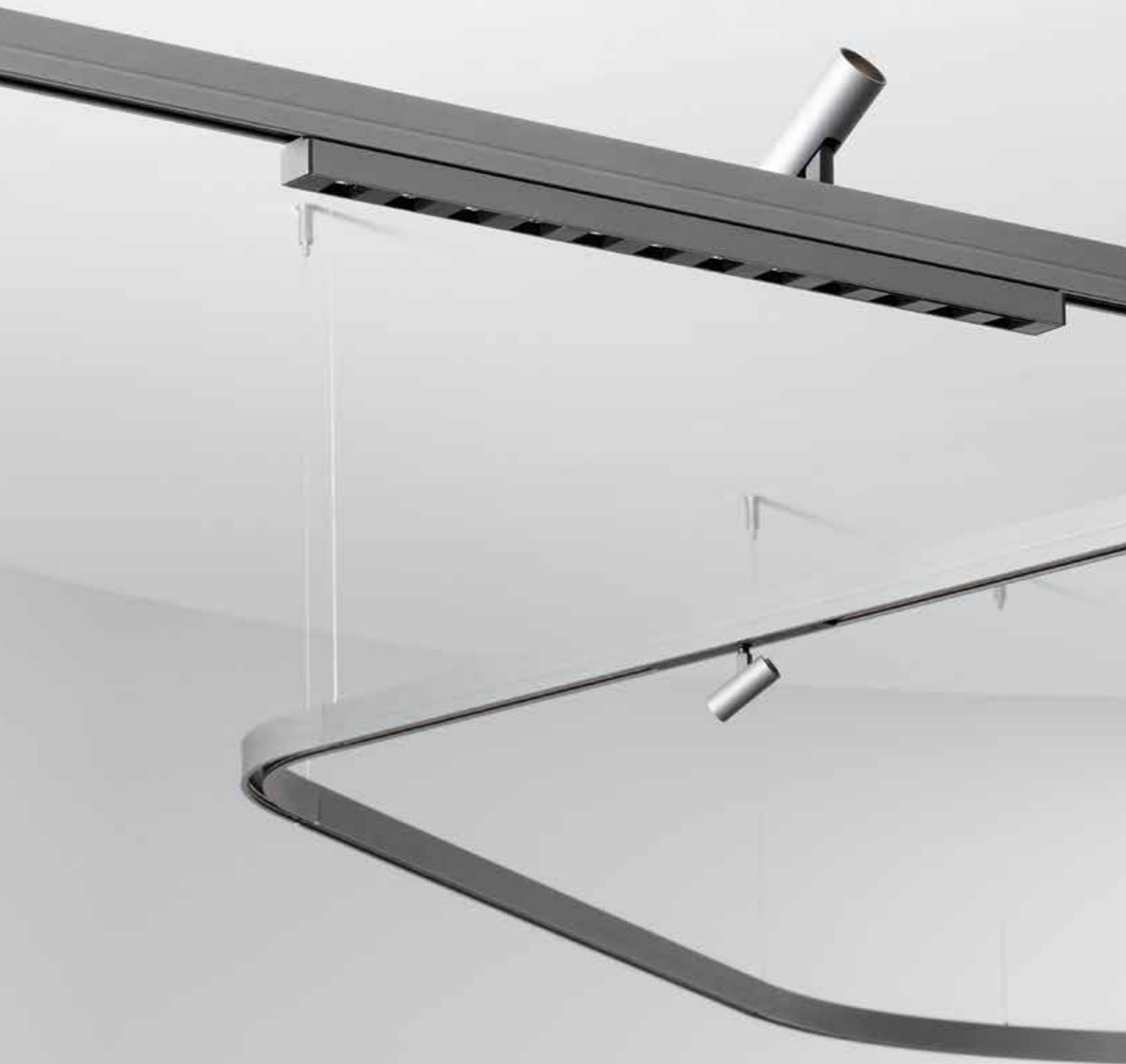



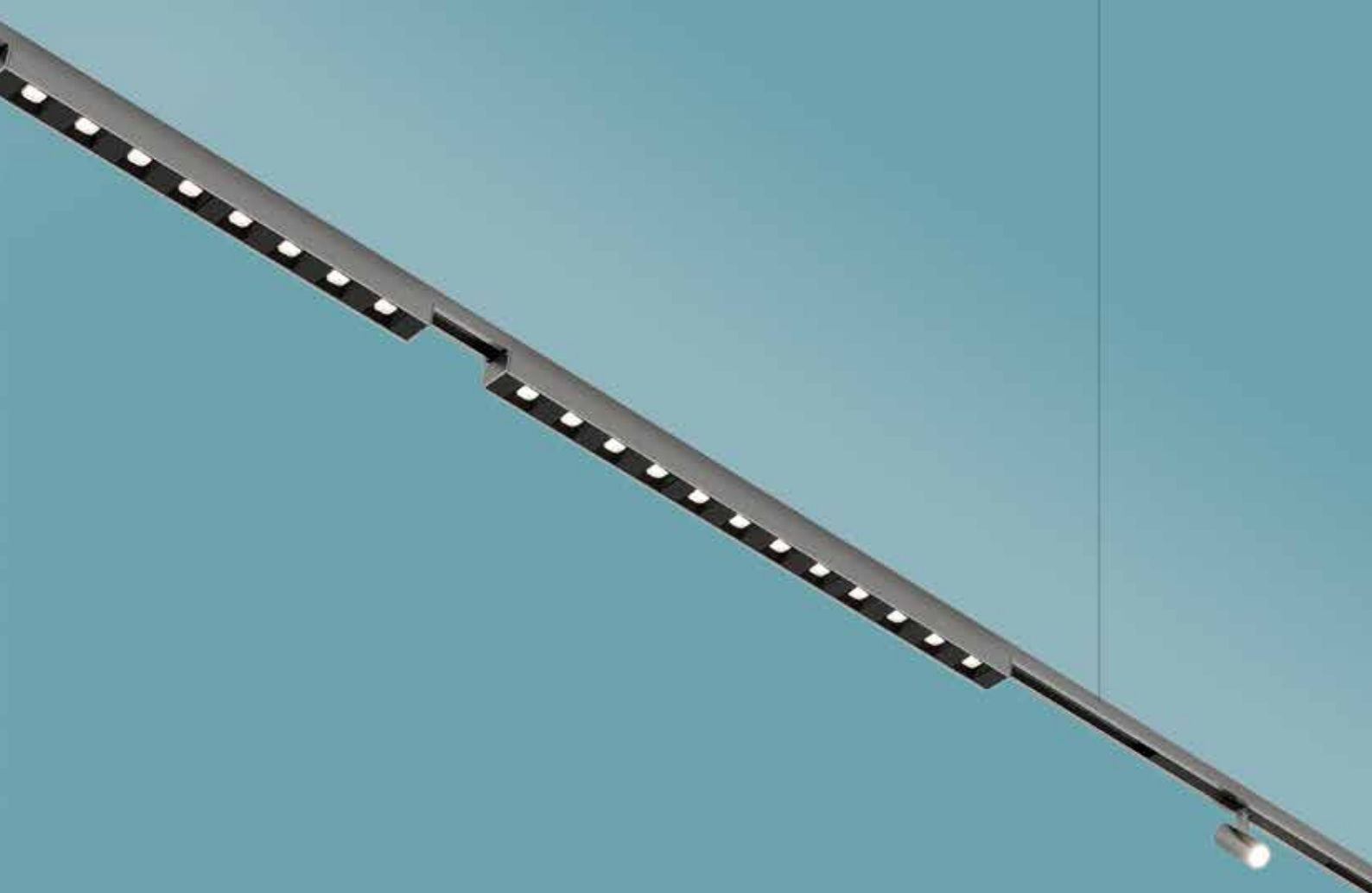

# Turn Around lighting appliances



# Vector Turn Around



# VECTOR TURN AROUND

Titanium



SP XF WF

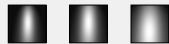

MacAdam 3SDCM  
CRI = 90

IP20



## Vector 20

W	Beam	Flux	CCT
3,5W	SP 16°	179 lm	2700K
		188 lm	3000K
		184 lm	4000K
3W	XF 23°	171 lm	2700K
		180 lm	3000K
		189 lm	4000K
3,5W	WF 35°	168 lm	2700K
		177 lm	3000K
		186 lm	4000K

## Dimmable\*\*

Code
<b>TB00122</b>
<b>TB01122</b>
<b>TB03122</b>
<b>TB00222</b>
<b>TB01222</b>
<b>TB03222</b>
<b>TB00322</b>
<b>TB01322</b>
<b>TB03322</b>



Life L90 (6K) > 36300h

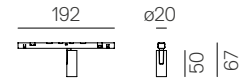

## Vector 30

W	Beam	Flux	CCT
6,5W	SP 12°	329 lm	2700K
		329 lm	3000K
		329 lm	4000K
7W	XF 16°	335 lm	2700K
		335 lm	3000K
		335 lm	4000K
	WF 30°	292 lm	2700K
		292 lm	3000K
		292 lm	4000K

## Dimmable\*\*

Code
<b>TB10122</b>
<b>TB11122</b>
<b>TB13122</b>
<b>TB10222</b>
<b>TB11222</b>
<b>TB13222</b>
<b>TB10322</b>
<b>TB11322</b>
<b>TB13322</b>



Life L70 (18K) > 109000h

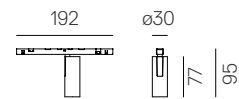

\*\* Use of Artemide power units is mandatory



# VECTOR TURN AROUND

Titanium



SP XF WF



MacAdam 3SDCM  
\*MacAdam 2SDCM  
CRI = 90



## Vector 40

W	Beam	Flux	CCT	Dimmable**
10W	SP 14°	544 lm	2700K	<b>TB20122</b>
		541 lm	3000K	<b>TB21122</b>
		541 lm	4000K	<b>TB23122</b>
	*XF 21°	543 lm	2700K	<b>TB20222</b>
		584 lm	3000K	<b>TB21222</b>
		626 lm	4000K	<b>TB23222</b>
	*WF 28°	491 lm	2700K	<b>TB20322</b>
		529 lm	3000K	<b>TB21322</b>
		566 lm	4000K	<b>TB23322</b>



Life L90 (10K) 60500h

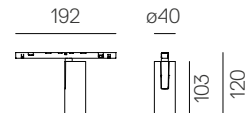

## Accessories

Accessories		Vector 40
		Code
	Accessories holder	<b>AP90100</b>
	Lens for elliptical emission	<b>AP90200</b>
	Soft filter	<b>AP90300</b>
	Anti-dazzle louvre	<b>AP90400</b>
		Code

\*\* Use of Artemide power units is mandatory



# VECTOR PENDANT TURN AROUND

Titanium



SP XF WF



MacAdam 3SDCM  
\* MacAdam 2SDCM  
CRI = 90



## Vector 30 Pendant

W	Beam	Flux	CCT
6,5W	SP 12°	329 lm	2700K
		329 lm	3000K
		329 lm	4000K
7W	XF 16°	335 lm	2700K
		335 lm	3000K
		335 lm	4000K
	WF 30°	292 lm	2700K
		292 lm	3000K
		292 lm	4000K

## Dimmable\*\*

Code
<b>TB30122</b>
<b>TB31122</b>
<b>TB33122</b>
<b>TB30222</b>
<b>TB31222</b>
<b>TB33222</b>
<b>TB30322</b>
<b>TB31322</b>
<b>TB33322</b>

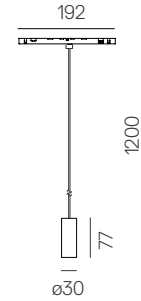

Life L70 (24K) 145000h

## Vector 40 Pendant

W	Beam	Flux	CCT
10W	SP 14°	544 lm	2700K
		541 lm	3000K
		541 lm	4000K
	*XF 21°	543 lm	2700K
		584 lm	3000K
	626 lm	4000K	
*WF 28°	491 lm	2700K	
	529 lm	3000K	
	566 lm	4000K	

## Dimmable\*\*

Code
<b>TB40122</b>
<b>TB41122</b>
<b>TB43122</b>
<b>TB40222</b>
<b>TB41222</b>
<b>TB43222</b>
<b>TB40322</b>
<b>TB41322</b>
<b>TB43322</b>

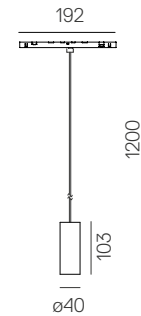

Life L90 (10K) 60500h



No cuttable wire  
Clips included to adjust the length

\*\* Use of Artemide power units is mandatory

# Sharp Turn Around



# SHARP TURN AROUND

Titanium



XF WF



MacAdam 2SDCM  
 \*MacAdam 3SDCM  
 CRI = 90  
 Life L70 (18K) 109000h

IP20



## Sharp 8

	W	Beam	Flux	CCT
8 LED	14W	XF 26°	1071 lm*	2700K
			1071 lm	3000K
			1147 lm	4000K
		XF 62°	1139 lm*	2700K
			1139 lm	3000K
			1219 lm	4000K

## Dimmable

Code
TB50222
TB51222
TB53222
TB50422
TB51422
TB53422

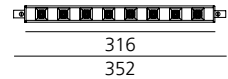

120  
27

## Sharp 12

	W	Beam	Flux	CCT
12 LED	19W	XF 26°	1607 lm*	2700K
			1607 lm	3000K
			1720 lm	4000K
		XF 62°	1708 lm*	2700K
			1708 lm	3000K
			1829 lm	4000K

## Dimmable

Code
TB60222
TB61222
TB63222
TB60422
TB61422
TB63422

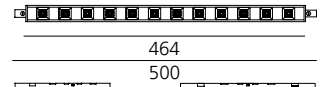
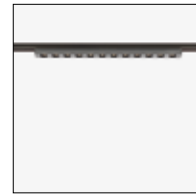

120  
27



# Diffused linear modules Turn Around

# DIFFUSED LINEAR MODULES TURN AROUND

Titanium



MacAdam 3SDCM  
CRI = 90

IP20

## Diffused linear module

	W	Flux	CCT
600 mm	15W	1340 lm	2700K
		1421 lm	3000K
		1421 lm	4000K
1200 mm	30W	2510 lm	2700K
		2843 lm	3000K
		2748 lm	4000K

## Dimmable

Code
<b>TD21022</b>
<b>TD22022</b>
<b>TD24022</b>
<b>TD31022</b>
<b>TD32022</b>
<b>TD34022</b>

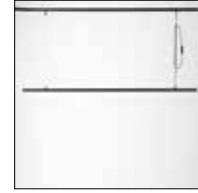

Life L70 (18K) 102000h

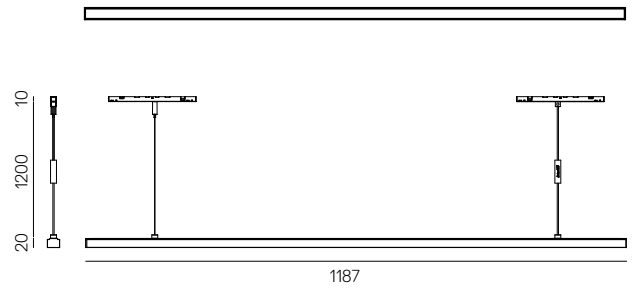
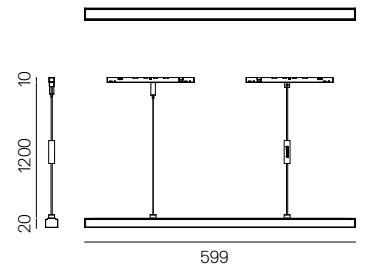

No cuttable wire  
Clips included to adjust the length



# **Diffused flexible modules Turn Around**

# DIFFUSED LINEAR MODULES TURN AROUND

Titanium



MacAdam 3SDCM  
CRI = 90

IP20  

## Diffused flexible modules\*

	W	Flux	CCT
2000 mm	18W	1000 lm	3000K
4500 mm	39W	2252 lm	3000K

## Dimmable

Code

**TB91922**

**TB90922**

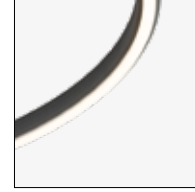

\* The adapter of the diffused flexible module can be fixed only in linear module

# Square modules Turn Around



# DIFFUSED LINEAR MODULES TURN AROUND

Titanium



MacAdam 3SDCM  
CRI = 90  
Life L70 (6K) 36000h

IP20

## Horizontal square diffused

W	Flux	CCT
18W	1001 lm	3000K

## Dimmable

Code  
**TB81922**

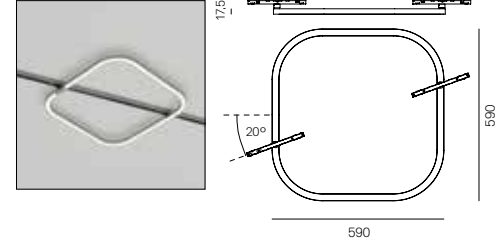

## Vertical square diffused

W	Flux	CCT
18W	1001 lm	3000K

## Dimmable

Code  
**TB71922**

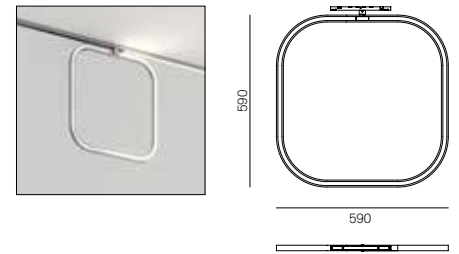

## Horizontal square track\*

Code  
**TB99922**

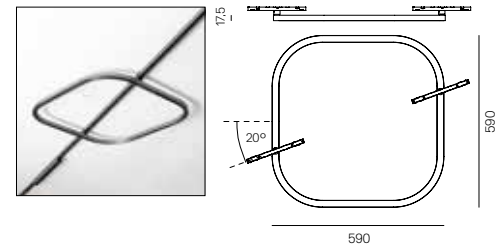

## \*Insets horizontal square track

Insets	N° Max
Vector 20	3
Vector 30	3
Vector 40	3
Vector 30 Pendant Track	3
Vector 40 Pendant Track	3
Sharp 8x	3

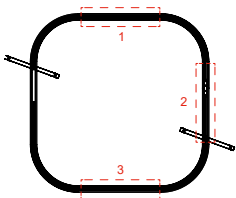





# Wall Washer Turn Around



# WALL WASHER TURN AROUND

Titanium



MacAdam 3SDCM  
 Life L70 (6K) 50000h  
 CRI = 90



Length	W	Flux	CCT	Code
600 mm	10W	900 lm	3000K	<b>WW02122</b>
		950 lm	4000K	<b>WW03122</b>
1200 mm	20W	1800 lm	3000K	<b>WW06222</b>
		1900 lm	4000K	<b>WW07222</b>

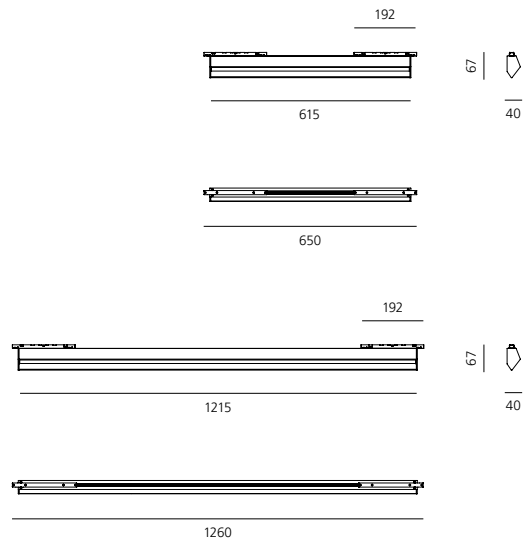



**Turn Around  
is inclusive**





# LIGHTING APPLIANCES TURN AROUND

Black	White	SP	XF	WF	MacAdam 2SDCM*	IP20
					MacAdam 3SDCM	
					CRI = 90	
					Delivery time on demand 2700K - 4000K	

## GOPLE MINI PENDANT TURN AROUND, BIG - BJARKE INGELS GROUP

W	Flux	CCT	Dimmable Code
9W	836 lm	2700K	<b>TC10401</b>
	850 lm	3000K	<b>TC11401</b>



Life L70 (9K) 50000h

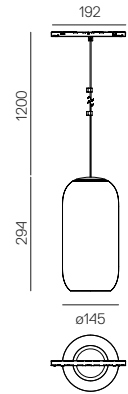

## GOPLE 60 PENDANT TURN AROUND, BIG - BJARKE INGELS GROUP

W	Colour	Beam	Flux	CCT	Dimmable Code
10W	Black	SP 13°	557 lm	2700K	<b>TC50104</b>
			557 lm	3000K	<b>TC51104</b>
			557 lm	4000K	<b>TC53104</b>
		XF 20°*	556 lm	2700K	<b>TC50204</b>
			598 lm	3000K	<b>TC51204</b>
			641 lm	4000K	<b>TC53204</b>
		WF 28°*	503 lm	2700K	<b>TC50304</b>
			542 lm	3000K	<b>TC51304</b>
			580 lm	4000K	<b>TC53304</b>



Life L70 (24K) 145000h

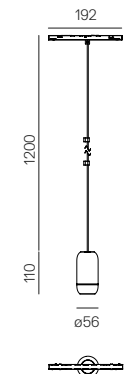

## GOPLE 80 PENDANT TURN AROUND, BIG - BJARKE INGELS GROUP

W	Colour	Beam	Flux	CCT	Dimmable Code
19W	Black	SP 16°	1739 lm	2700K	<b>TC40104</b>
			1779 lm	3000K	<b>TC41104</b>
			1845 lm	4000K	<b>TC43104</b>
		XF 22°	1837 lm	2700K	<b>TC40204</b>
			1879 lm	3000K	<b>TC41204</b>
			1949 lm	4000K	<b>TC43204</b>
		WF 32°	1986 lm	2700K	<b>TC40304</b>
			2031 lm	3000K	<b>TC41304</b>
			2107 lm	4000K	<b>TC43304</b>



Life L70 (9K) 50000h

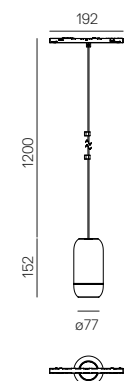

No cuttable wire  
Clips included to adjust the length



# LIGHTING APPLIANCES TURN AROUND

White



MacAdam 2SDCM  
CRI = 90  
Life L70 (24K) 145000h

IP20



## SPHERE 9 PENDANT TURN AROUND

W	Flux	CCT	Dimmable
4W	346 lm	2700K	Code
	373 lm	3000K	<b>TC30406</b>
			<b>TC31406</b>



Life L70 (11K) 61000h

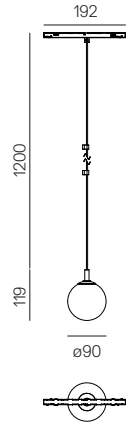

## SPHERE 14 PENDANT TURN AROUND

W	Flux	CCT	Dimmable
8,5W	628 lm	2700K	Code
	677 lm	3000K	<b>TC20406</b>
			<b>TC21406</b>



Life L70 (19K) 105000h

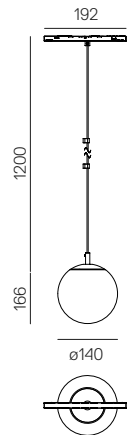

No cuttable wire  
Clips included to adjust the length



# LIGHTING APPLIANCES TURN AROUND

Aluminium Brass



MacAdam 2SDCM  
CRI = 90

IP20



## ORSA 21 PENDANT TURN AROUND, FOSTER + PARTNERS INDUSTRIAL DESIGN

W	Flux	CCT	Dimmable
8W	525 lm	2700K	Code
	562 lm	3000K	<b>TC60404</b>
			<b>TC61404</b>



Life L70 (9K) 50000h

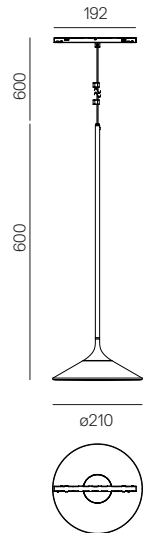

## UNTERLINDEN PENDANT TURN AROUND, HERZOG & DE MEURON

W	Colour	Flux	CCT	Dimmable
7W	Brass	339 lm	2700K	Code
	Aluminum			<b>TC70406</b>
	Brass	349 lm	3000K	<b>TC70407</b>
	Aluminum			<b>TC71406</b>
				<b>TC71407</b>



Life L70 (19K) 105000h

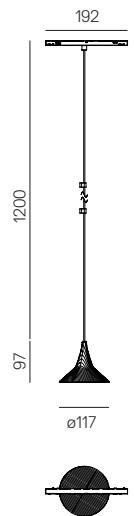

No cuttable wire  
Clips included to adjust the length



# LIGHTING APPLIANCES TURN AROUND

Black



MacAdam 3SDCM  
CRI = 90

IP20



## DISCOVERY 70 VERTICAL PENDANT TURN AROUND, ERNESTO GISMONDI

W	Colour	Flux	CCT	Dimmable Code
29W	Black	2317 lm	3000K	<b>TC01404</b>



Life L70 (9K) 50000h

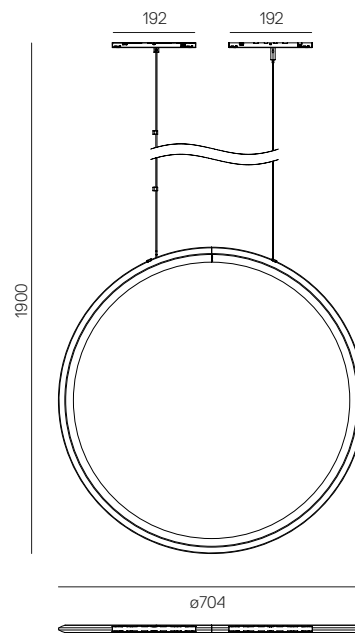

No cuttable wire  
Clips included to adjust the length

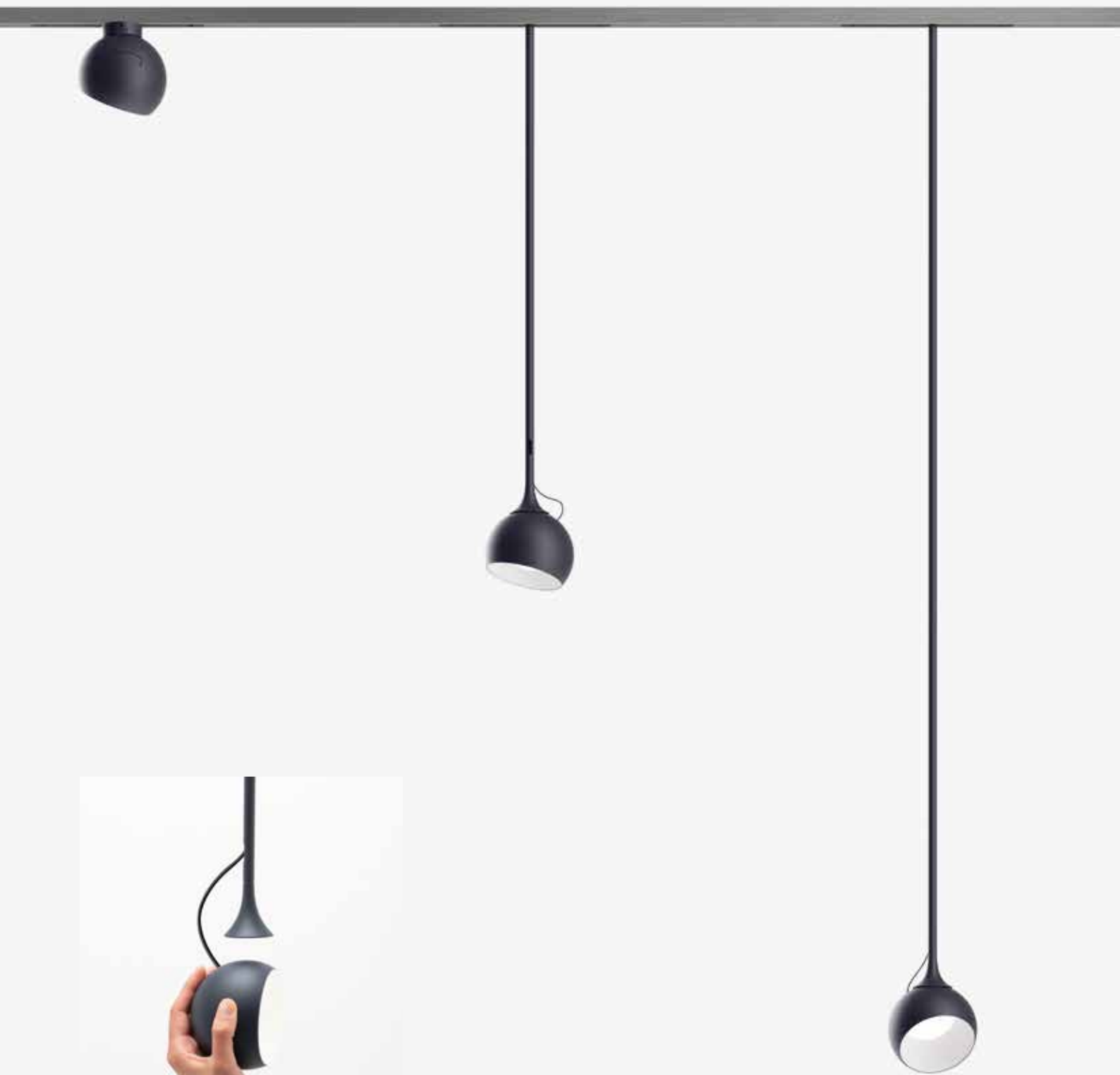

# LIGHTING APPLIANCES TURN AROUND

Anthracite

Blue

White/  
Grey

Yellow



04

07

01

06

MacAdam 2SDCM  
CRI = 90  
Life L70 (10K) 60500h

IP20

## IXA SPOT TURN AROUND, FOSTER + PARTNERS INDUSTRIAL DESIGN

W	Flux	CCT	Color	Dimmable Code
9W	465 lm	3000K	Anthracite	<b>TC81004</b>
			Blue	<b>TC81007</b>
			White / Grey	<b>TC81001</b>
			Yellow	<b>TC81006</b>

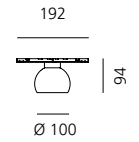
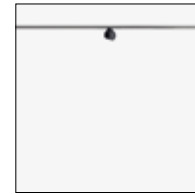

## IXA 50 TURN AROUND, FOSTER + PARTNERS INDUSTRIAL DESIGN

W	Flux	CCT	Color	Dimmable Code
9W	465 lm	3000K	Anthracite	<b>TC81104</b>
			Blue	<b>TC81107</b>
			White / Grey	<b>TC81101</b>
			Yellow	<b>TC81106</b>

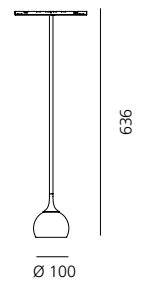
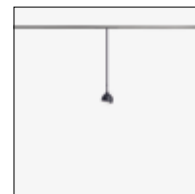

## IXA 100 TURN AROUND, FOSTER + PARTNERS INDUSTRIAL DESIGN

W	Flux	CCT	Color	Dimmable Code
9W	465 lm	3000K	Anthracite	<b>TC81204</b>
			Blue	<b>TC81207</b>
			White / Grey	<b>TC81201</b>
			Yellow	<b>TC81206</b>

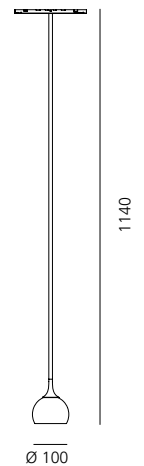
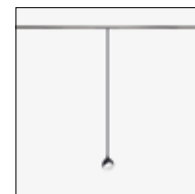













Reire, Reggio Emilia, Italy, ph. Michele Nastasi

Olmo Restaurant, Cornaredo, Italy, ph. Michele Nastasi









Cesce Piumini Store, Milan, Italy, ph: Federico Motta

# Turn Around floor

Carlotta de Bevilacqua  
2023

Turn Around floor shares the same design principles of Turn Around system starting from parameters of sustainability, reduction, lightness, optoelectronic intelligence and interaction. Like the system it is perfect for a last-minute choice able to add dynamic light quality to the space.

The slender and minimal structure integrates two different lighting performances to meet the needs of any space, from office workstations to meeting rooms, hospitality or residential spaces.

Turn Around floor combines to the direct controlled emission also an indirect diffuse emission which can be managed separately both from the luminaire body.

The high efficiency and the flexibility of emissions management make Turn Around floor an optimal solution for intelligent energy saving that enhances the experience and the awareness of the user.



For further information on Turn Around floor  
visit [artemide.com](http://artemide.com)



# Refractive emission

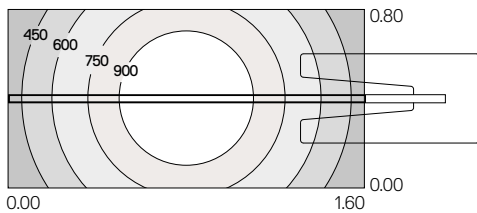

Refractive direct  
Head h 2015 mm - Desk h 750 mm  
 $E_{av} = 708 \text{ lx}$   $u_0 = 0,444$

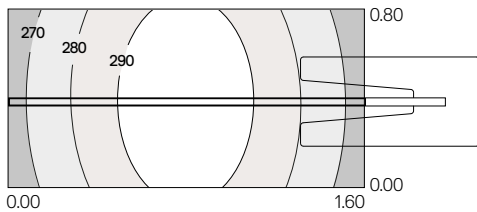

Diffused indirect  
Head h 2015 mm - Desk h 750 mm  
 $E_{av} = 281 \text{ lx}$   $u_0 = 0,942$

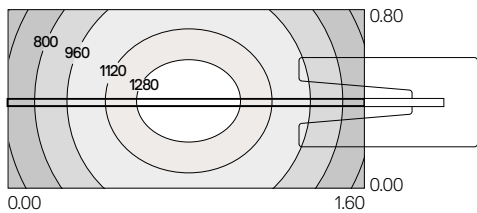

Refractive Direct + Diffused indirect  
Head h 2015 mm - Desk h 750 mm  
 $E_{av} = 989 \text{ lx}$   $u_0 = 0,584$

**High Efficiency**  
more than 70%

**High Efficacy**  
up to 115 lm/W

**High Glare Control**  
UGR < 16

**CRI = 90**

Lighting calculation parameters used for Isolux diagrams: office with a single workstation.

Length x width x height: 5.00 x 5.00 x 2.70 m

Reflection factor ceiling / wall / floor: 70 / 50 / 20 %

Desk: 1.60 x 0.80 x 0.75 m

Maintenance factor: 0.90 WF



## Capacitive board for light management



**Indirect emission**

On / Off

Dimming



**Direct + Indirect emission**

On / Off

Intensity setting



**Direct emission**

On / Off

Dimming

## Sensor

Intensity setting and daylight

PIR (proximity)





**Workplace**

- 1 - Direct and indirect emission
- 2 - Direct emission
- 3 - Indirect emission





# TURN AROUND FLOOR

Titanium



MacAdam 3SDCM  
CRI = 90  
Life L70 (17k ) 102000h

IP20

## Turn Around floor, direct + indirect emission

Weight	W	Flux	CCT
20 Kg	17W direct	1824 lm	3000K
		6197 lm	3000K
	53W indirect	1824 lm	4000K
		6197 lm	4000K

## Dimmable

Code
TE22022
TE23022

## Dimmable + sensor\*

Code
TE22122
TE23122

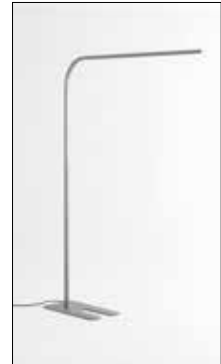

\*Sensor functionalities:

- Intensity setting and daylight (touching for 3 seconds the central part of the controller)
- PIR (proximity)

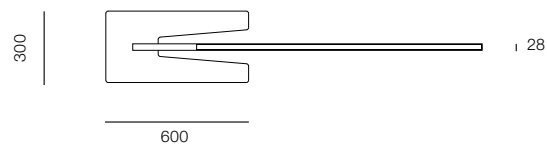
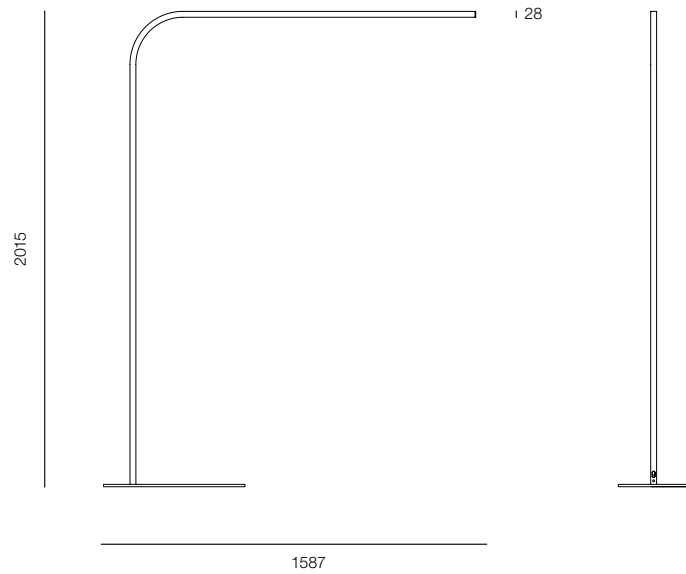





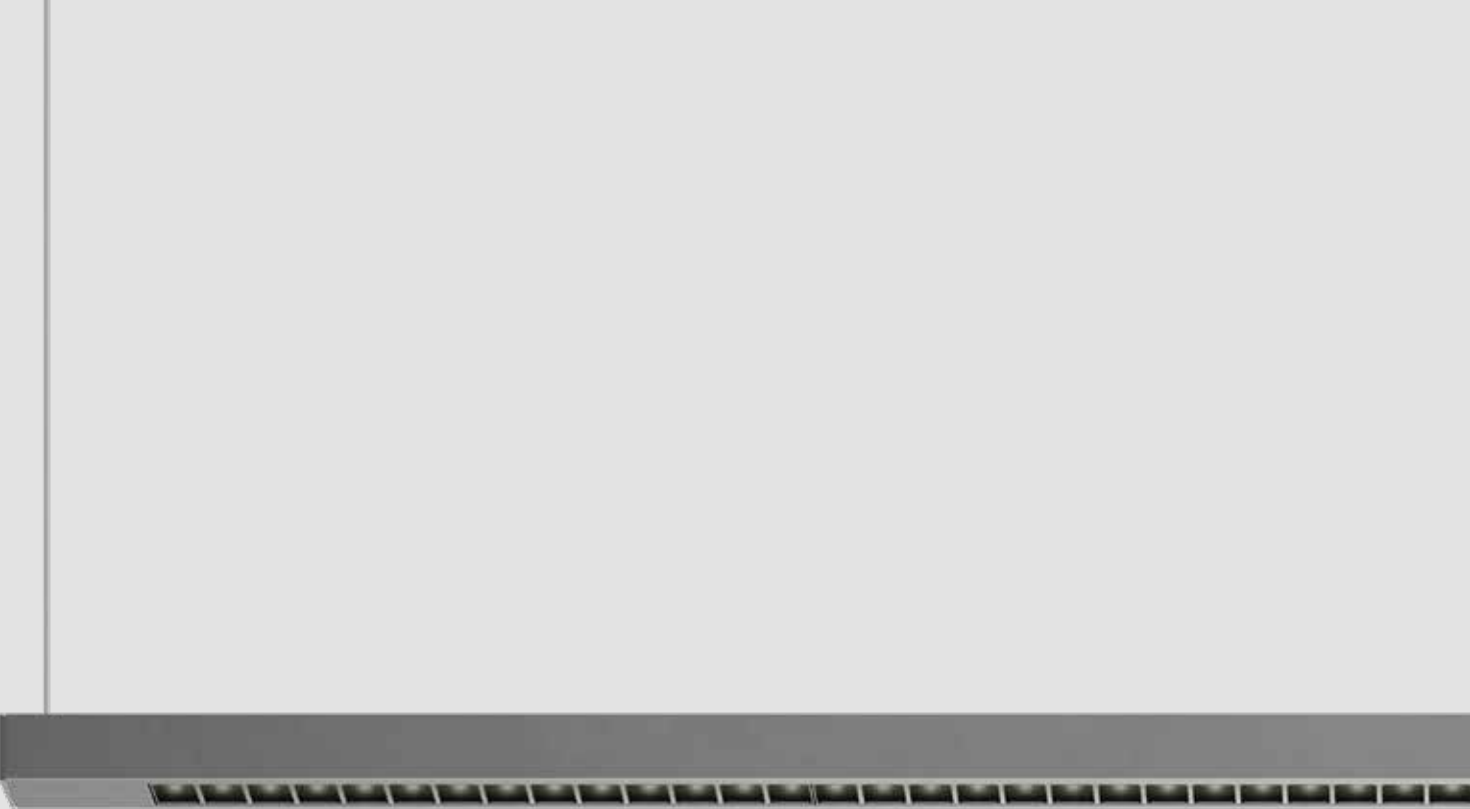

# Turn Around suspension

Carlotta de Bevilacqua  
2024

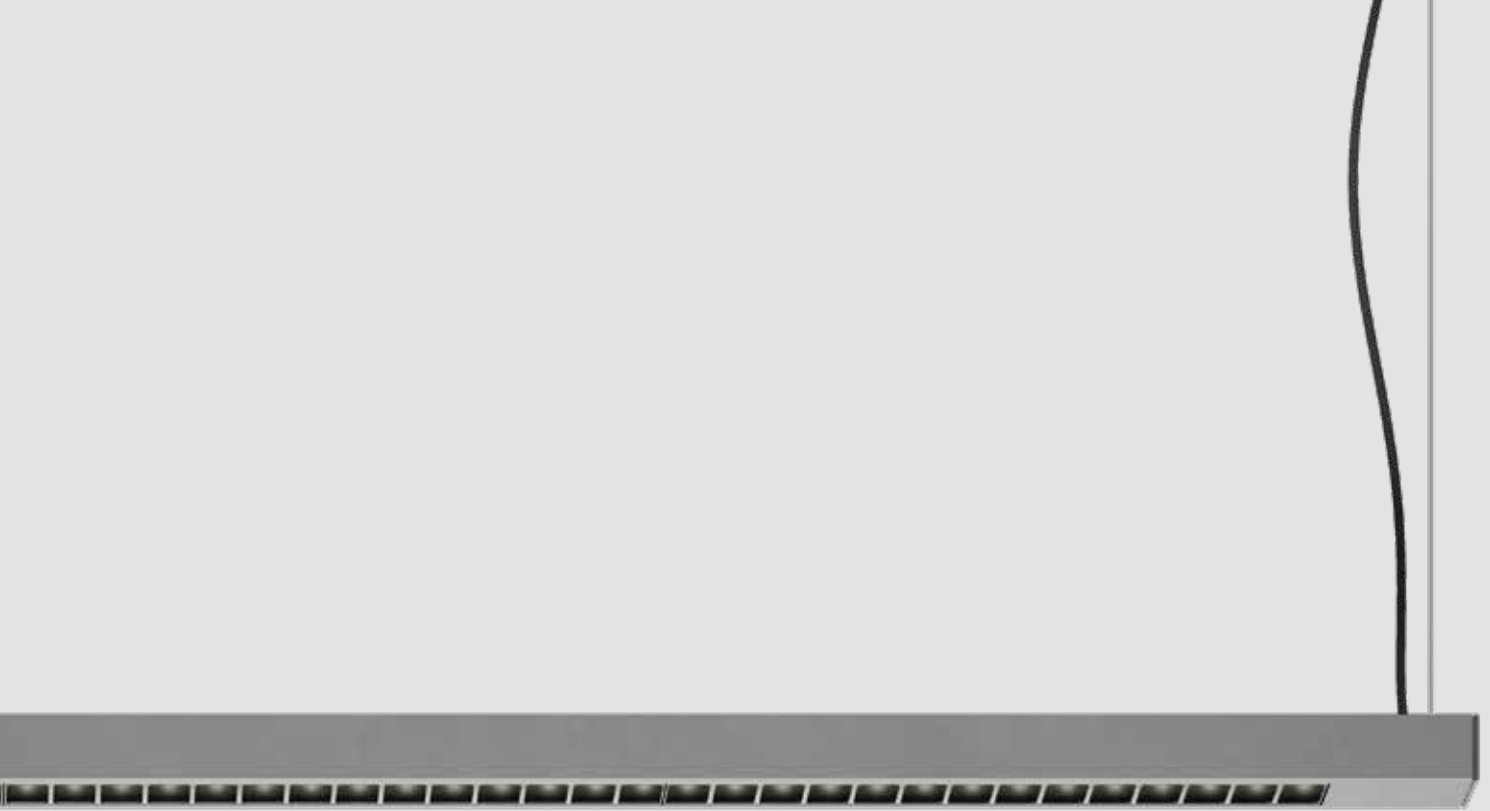

Turn Around suspension shares the same design principles of Turn Around system starting from parameters of sustainability, reduction, lightness, integration, optoelectronic intelligence, application freedom and interaction.

It also shares the same components of Turn Around floor, integrating in the minimal structure two different lighting performances.

Turn Around suspension combines a direct controlled emission to an indirect diffused emission manageable together.

The high efficiency and the perfect control of the lighting emission make Turn Around suspension an optimal solution for workplaces.

Controlled direct emission

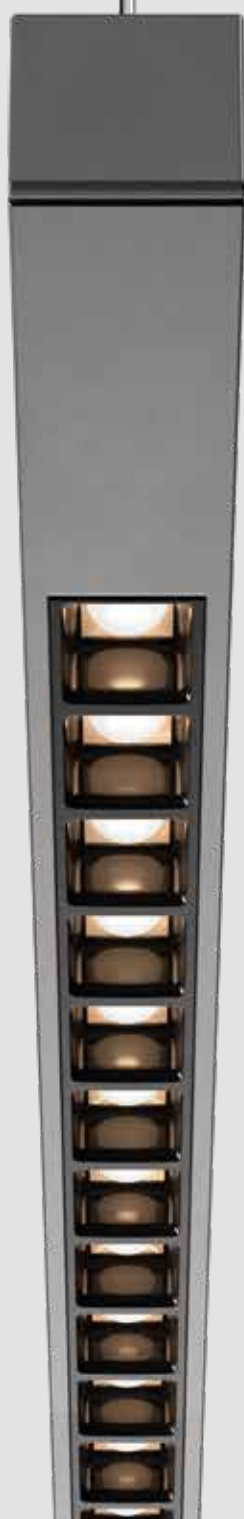

## Refractive emission

**High Efficiency**  
more than 70%

**High Efficacy**  
up to 115 lm/W

**High Glare Control**  
UGR<16

**CRI = 90**

Diffused indirect emission



## Combined management

Direct and Indirect emission  
DALI / Push

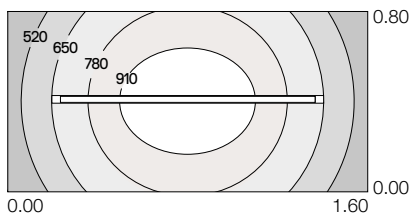

Refractive Direct + Diffused indirect  
 Head h 2100 mm - Desk h 750 mm  
 $E_{av} = 732 \text{ lx}$   $u_o = 0,526$   
 Power: 17W Direct + 17W Indirect  
 Flux: 1940 lm + 7500 lm (3000K)

Lighting calculation parameters used for Isolux diagrams:

Office with a single workstation.

Length x width x height: 5.00 x 5.00 x 2.70 m

Reflection factor ceiling / wall / floor: 70 / 50 / 20%

Desk: 1.60 x 0.80 x 0.75 m

Maintenance factor: 0.90 WF

**Turn Around suspension**

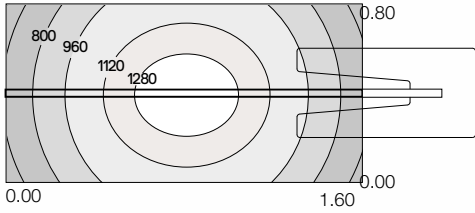
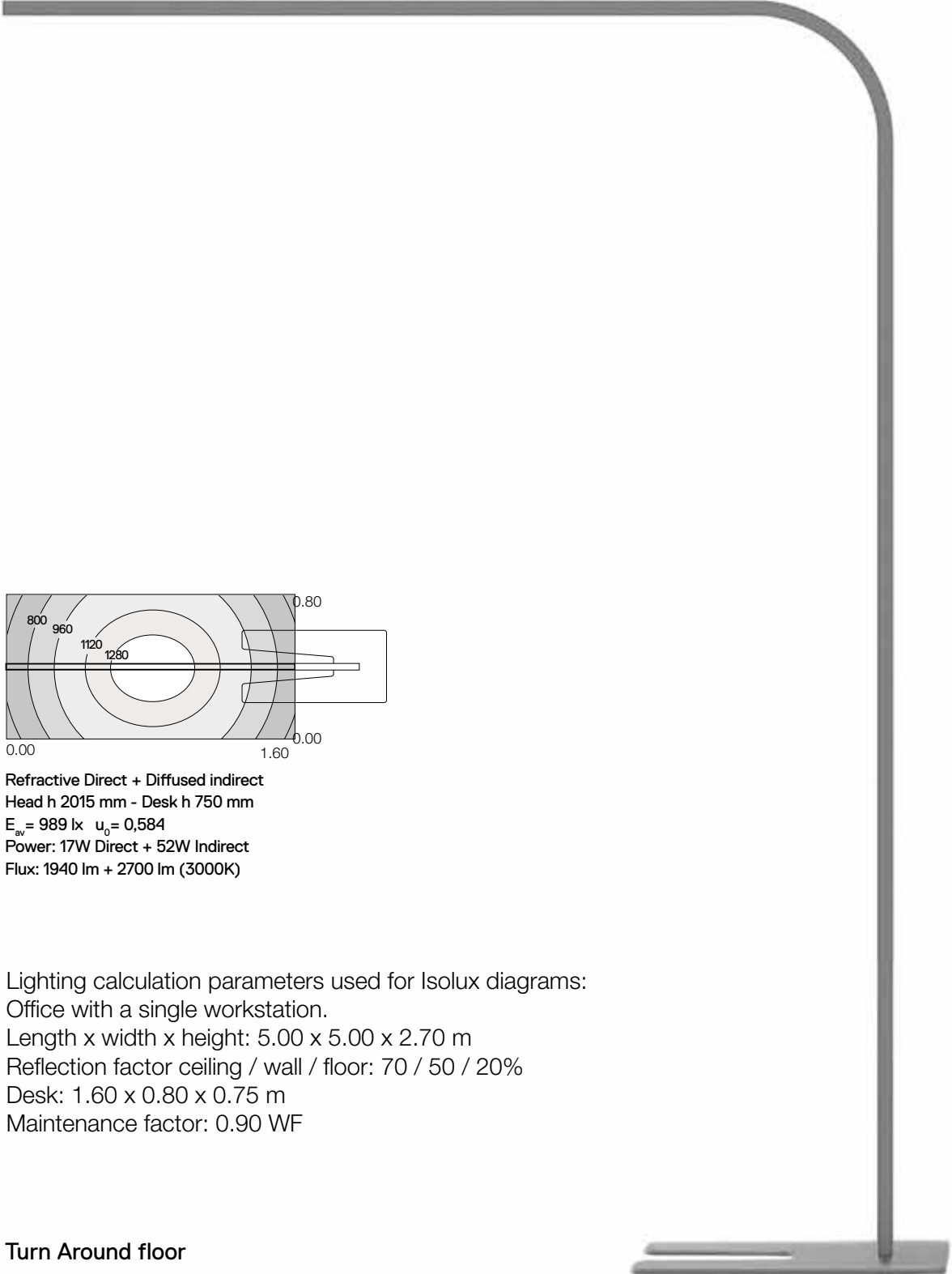

Refractive Direct + Diffused indirect  
Head h 2015 mm - Desk h 750 mm  
 $E_{av} = 989 \text{ lx}$   $u_0 = 0,584$   
Power: 17W Direct + 52W Indirect  
Flux: 1940 lm + 2700 lm (3000K)

Lighting calculation parameters used for Isolux diagrams:  
Office with a single workstation.  
Length x width x height: 5.00 x 5.00 x 2.70 m  
Reflection factor ceiling / wall / floor: 70 / 50 / 20%  
Desk: 1.60 x 0.80 x 0.75 m  
Maintenance factor: 0.90 WF

Turn Around floor



# TURN AROUND SUSPENSION

Titanium



MacAdam 3SDCM  
CRI = 90  
Life L70 (17K) 102000h

IP20  
⊕

## Turn Around suspension, direct + indirect emission

W	Flux	CCT
17W direct	1724 lm	2700K
17W indirect	2640 lm	
	1830 lm	3000K
	2818 lm	
	1940 lm	4000K
	2700 lm	

## Dimmable DALI/Push

Code
<b>TF21022</b>
<b>TF22022</b>
<b>TF23022</b>

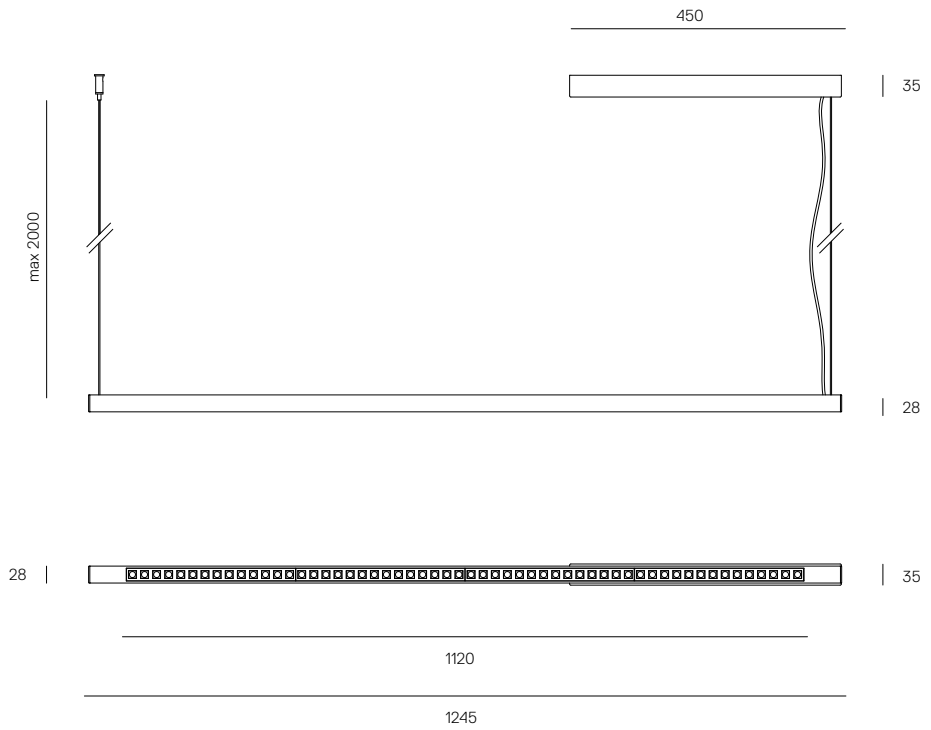





## Headquarters

### Artemide S.p.A.

Via Bergamo, 18  
20010 Pregnana Milanese (MI), Italy  
Tel. +39 02 93518.1  
Tel. +39 02 93526.1  
Numero verde 800 834 093  
(from Italy only)  
info@artemide.com  
artemide.com

### Artemide S.p.A.

si riserva la facoltà di modificare, in qualunque momento e senza preavviso, le caratteristiche tecniche degli elementi illustrati nel presente catalogo.

### Artemide S.p.A.

reserves the right to change, at any time and without prior warning, the technical specifications of any product illustrated in this catalogue.

### Artemide S.p.A.

se réserve le droit de modifier, à n'importe quel moment et sans préavis, les caractéristiques techniques des éléments illustrés dans ce catalogue.

### Artemide S.p.A.

behält sich das Recht vor jederzeit und ohne Ankündigung die technischen Daten der im Katalog abgebildeten Produkte zu ändern.

### Artemide S.p.A.

se reserva la facultad de modificar, en cualquier y sin aviso previo, las características técnicas de los elementos ilustrados en el presente catálogo.

V.1 2026