

# Discovery

Ernesto Gismondi



**Artemide®**



**discovery family**

# Discovery

Ernesto Gismondi

2015

Discovery is an element that does not invade the environment, totally absent and dematerialized acquires volume when it is turned on thanks to the light that draws the central emitting surface.

In 2018 Discovery was awarded the Compasso D'Oro, for its ability to interpret research, technological and material innovation, know-how and attention to the quality of light for human wellbeing. Discovery is a family of appliances based on minimal geometry. A very light aluminum ring houses a LED strip that injects light into a specially worked surface of transparent PMMA. The diffuser is composed of a perfectly transparent PMMA surface, processed with micro particles so small that the surface is hardly perceptible when the appliance is turned off.

When the appliance is turned on, the transparent interior appears to fill with light as if by magic, as absence is turned into a perfectly diffusing emitting surface.

This unique result is obtained through Discovery's direct and indirect emissions, which produce an embracing and uniform light. Their geometry and layout are calculated to obtain constant emission throughout the surface.

Discovery is an unprecedented development of a well-known optical principle, conveyed through the controlled interaction with matter and a focus on its yield and perceptive qualities.

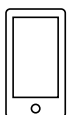

ARTEMIDE  
APP



red dot design award  
2017

Ph. Pierpaolo Ferrari | 2018

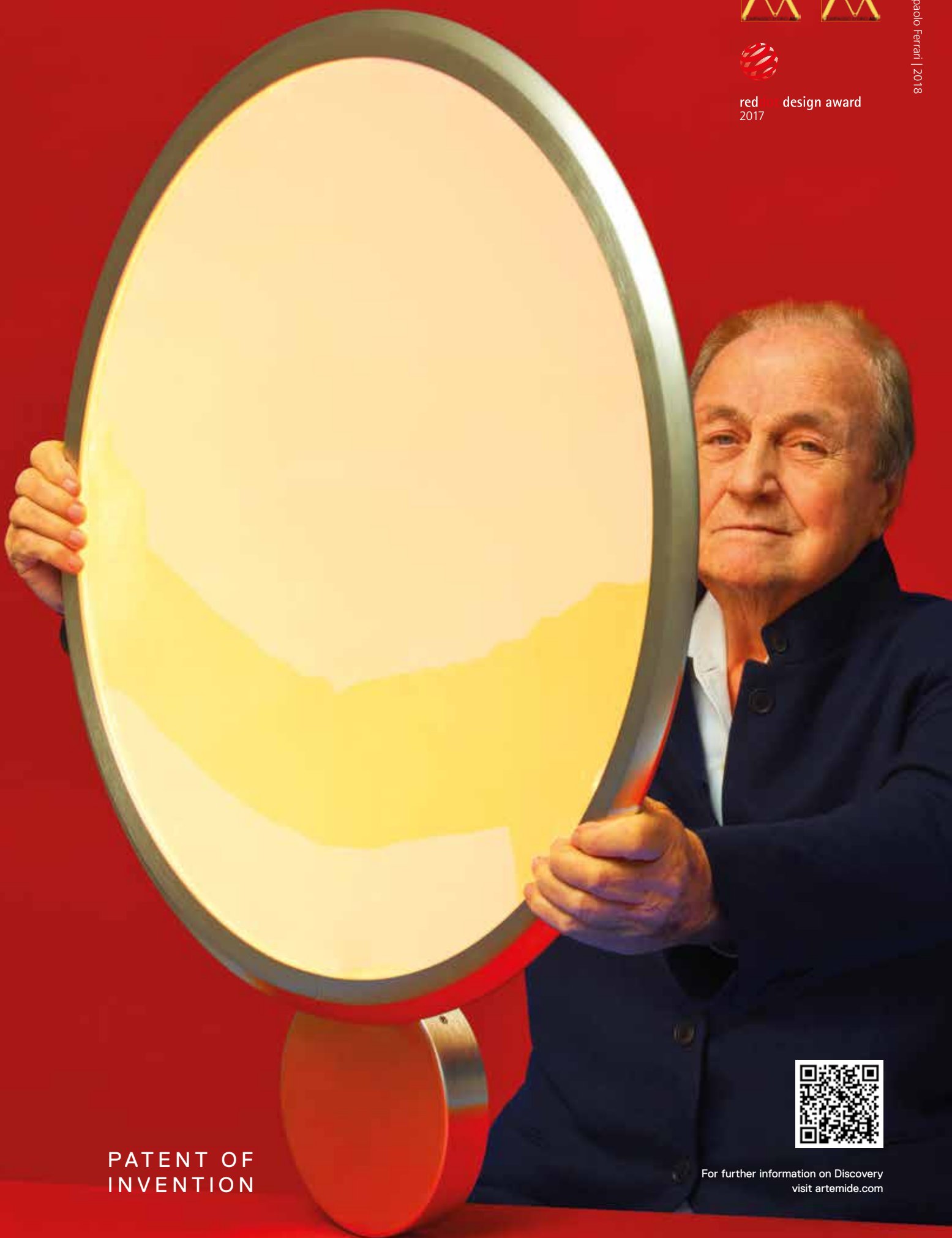

PATENT OF  
INVENTION



For further information on Discovery  
visit [artemide.com](http://artemide.com)





Discovery  
is **visible**



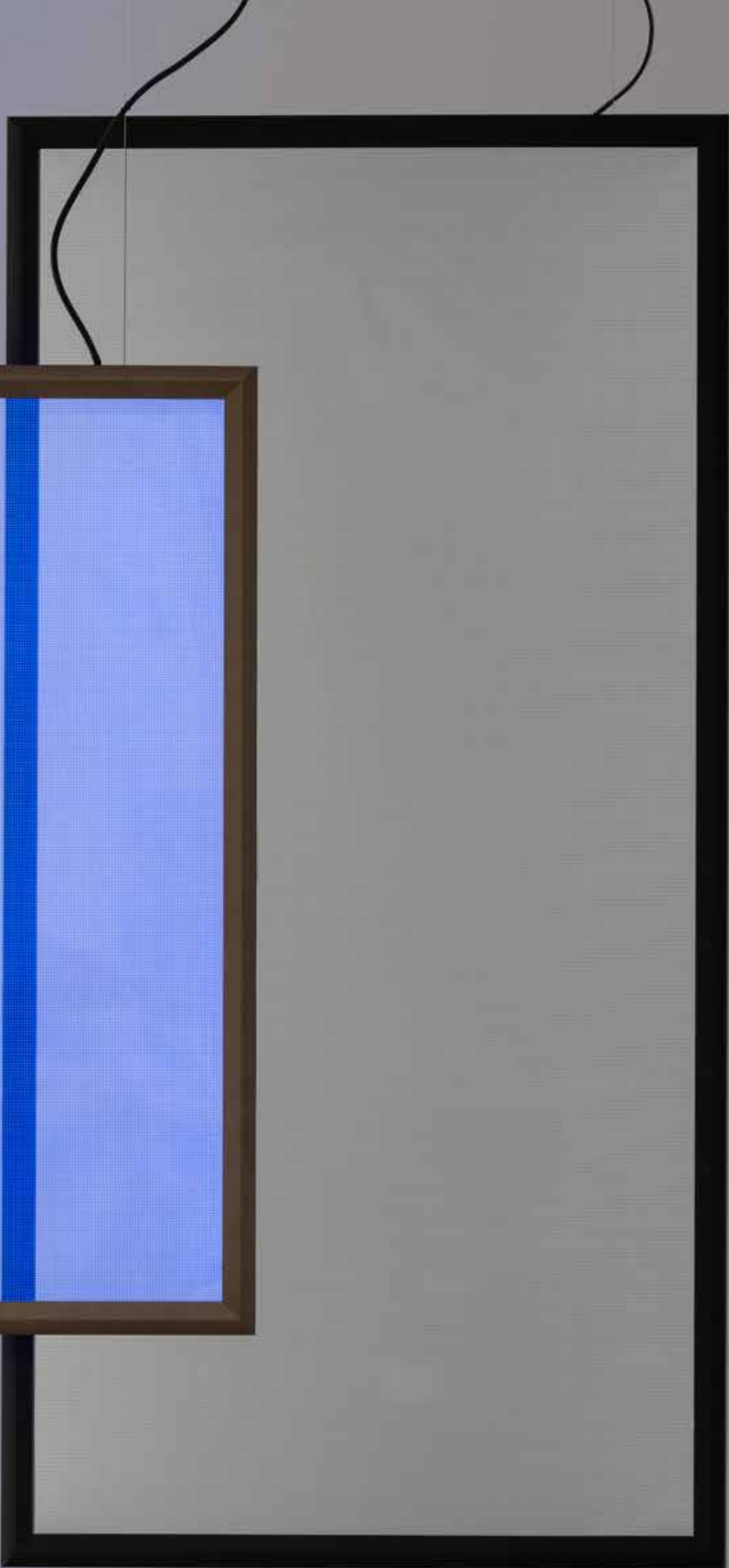

**is**  
invisible



# 3 Finishes Silver, Black, Brushed bronze



# Patent of Invention

Discovery, thanks to its invention patent, is increasingly the perfect synthesis of Artemide's values, knowledge, innovative research and know-how.

An ultra-lightweight circular aluminium profile houses an LED strip that injects light into a transparent PMMA surface with a pattern of distributed micro-incisions for maximum efficiency and uniformity.







## UGR<19

Uniform and diffuse light suitable for workplaces

High-end and innovative technology

Maximum efficiency and uniformity

Perfectly transparent surface

Extracting light

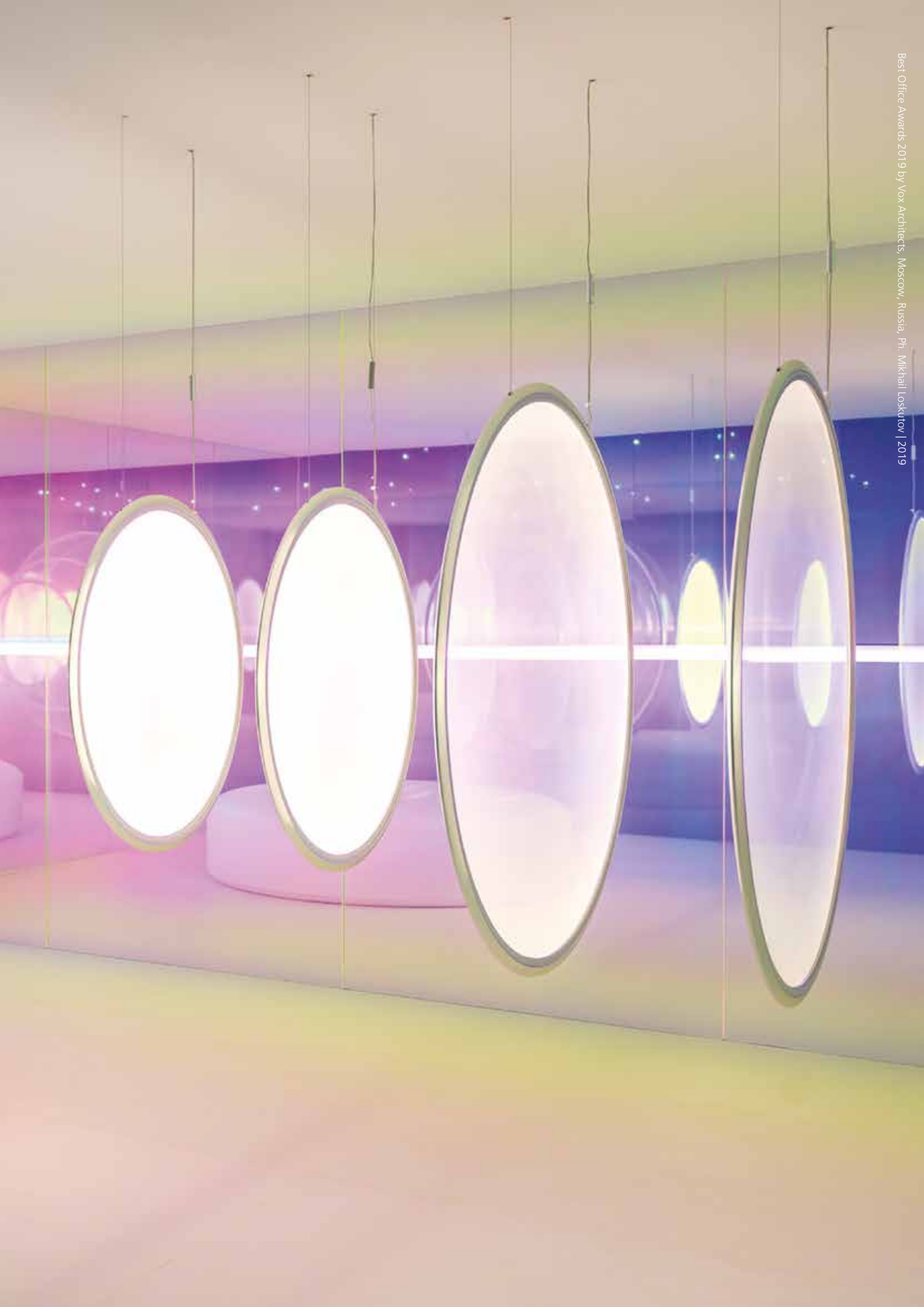

# Discovery

An ultra-light aluminum profile hosts a LED strip that injects light into a technopolymer surface with microengravings.

The microengravings pattern ensures maximum efficiency and uniformity in direct and indirect emission.

Dimmable devices (push dimmer and Artemide App).











# Discovery typologies

## SUSPENSION



DISCOVERY



XF  
(>45°)  
40 W  
2857 lm

## VERTICAL

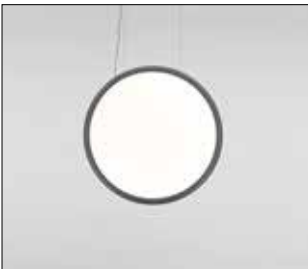

DISCOVERY VERTICAL Ø700/  
TW/RGBW

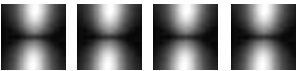

XF (>45°) 40 W 2857 lm	TW (>45°) 50 W 3343 lm	RGBW (>45°) 42 W 2471 lm	Integralis® (>45°) 42 W 1852 lm
---------------------------------	---------------------------------	-----------------------------------	--



DISCOVERY VERTICAL Ø1000/  
TW/RGBW

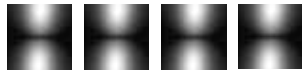

XF (>45°) 60W 4859 lm	TW (>45°) 71W 4775 lm	RGBW (>45°) 59W 3140 lm	Integralis® (>45°) 60 W 2646 lm
--------------------------------	--------------------------------	----------------------------------	--



DISCOVERY VERTICAL Ø1400/  
TW/RGBW

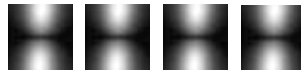

XF (>45°) 80W 6762 lm	TW (>45°) 84W 5650 lm	RGBW (>45°) 79W 4123 lm	Integralis® (>45°) 84 W 3704 lm
--------------------------------	--------------------------------	----------------------------------	--

## WALL



DISCOVERY WALL



XF  
(>45°)  
40 W  
2857 lm

## DIALOGUE



DISCOVERY DIALOGUE/RGBW



RGBW  
(>45°)  
36 W  
1117 lm

## SPACE

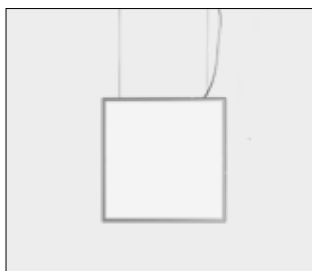

DISCOVERY SPACE SQUARE/  
TW/RGBW



XF (>45°)	TW (>45°)	RGBW (>45°)	Integralis® (>45°)
34 W	44 W	36 W	42 W
1955 lm	2739 lm	1708 lm	1852 lm

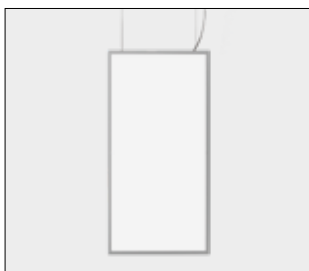

DISCOVERY SPACE  
RECTANGULAR/TW/RGBW



XF (>45°)	TW (>45°)	RGBW (>45°)	Integralis® (>45°)
52W	62W	54W	63 W
4002 lm	3775 lm	2664 lm	2778 lm

## SPOT

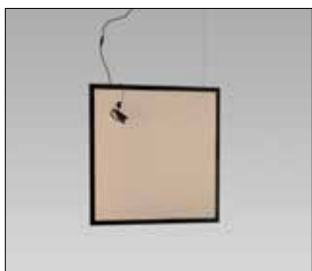

DISCOVERY SPOT SQUARE  
TW



TW (>45°)
44 W
2749 lm



DISCOVERY SPOT  
RECTANGULAR TW



TW (>45°)
62W
3789 lm

## FLOOR

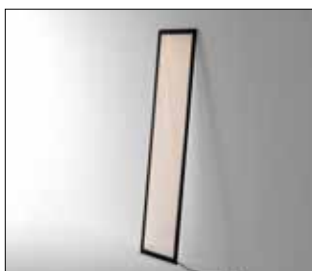

DISCOVERY FLOOR TW/  
RGBW/INTEGRALIS®

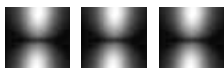

TW (>45°)	RGBW (>45°)	Integralis (>45°)
61 W	56 W	67 W
2527 lm	1923 lm	2972 lm

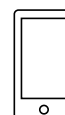

ARTEMIDE  
APP







# RGB White

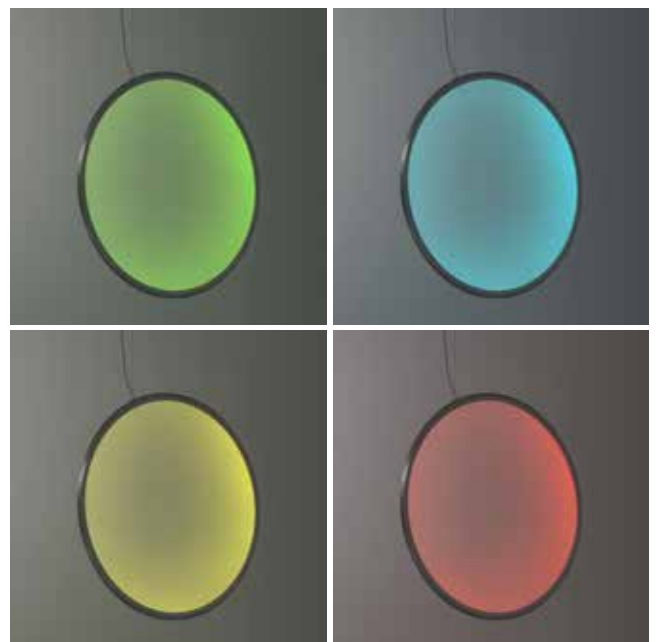

**RGBW**



# Tunable White



**TW**



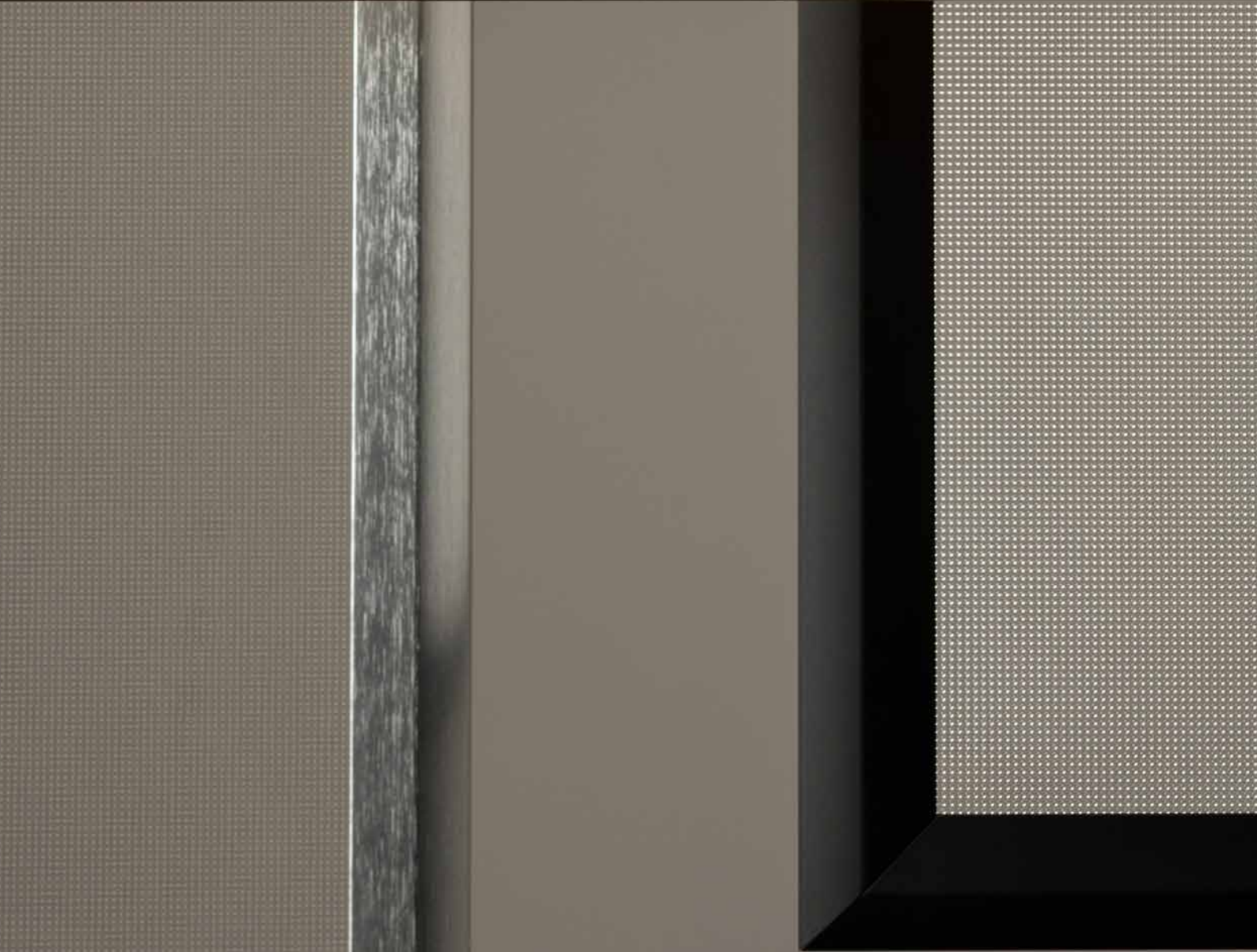
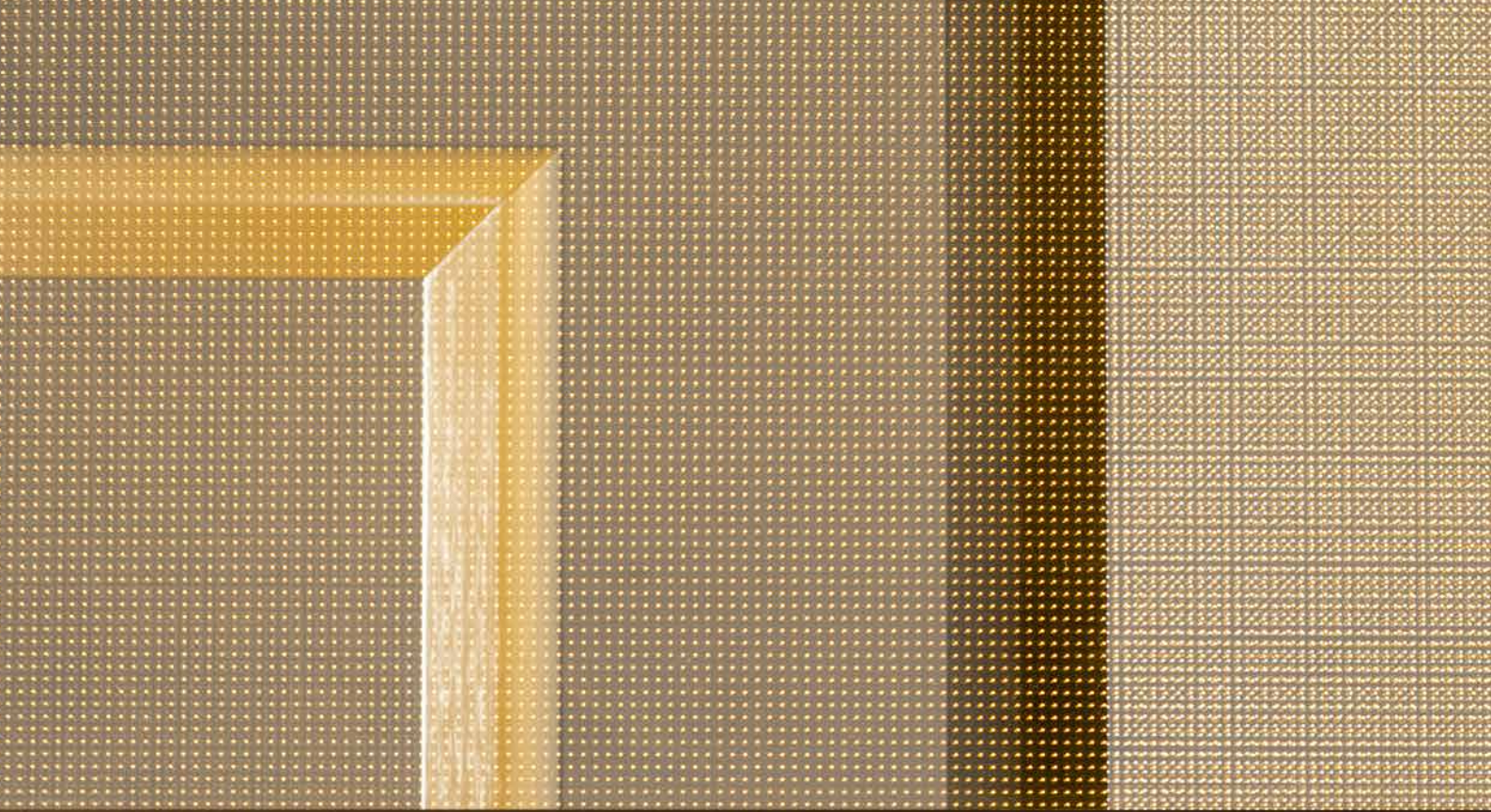

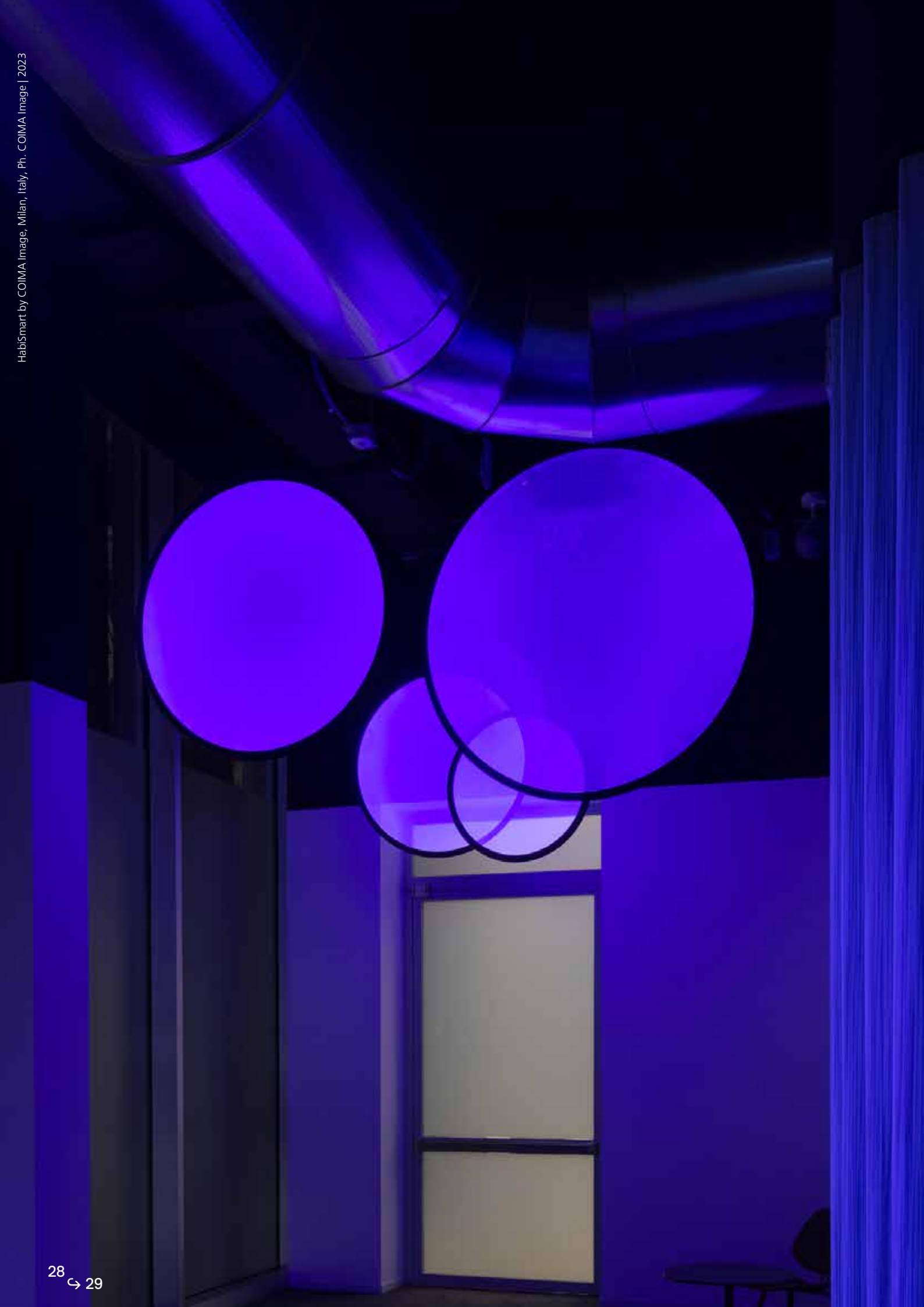

# INTEGRALIS®







# DISCOVERY SUSPENSION

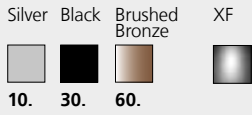

The APP driver can not be controlled by DALI dimming system and viceversa.

MacAdam 3SDCM  
Life L90 (6K) 50000h  
CRI =90

IP20

## DISCOVERY SUSPENSION

W	Beam	Flux	CCT
40 W	XF	2857 lm	3000K

PUSH/DALI
Code <b>19991.10/30/60.A</b>

PUSH & APP
Code <b>19991.10/30/60.APP</b>

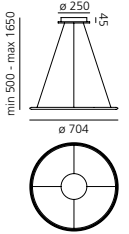

### Optional control devices - BLL wireless switch



Device for switching and controlling Artemide App products.  
Max N.3 inputs for external push buttons.  
Mains power supply required.  
To be installed inside flush mounting boxes or junction boxes.

**DV1080APP**



# DISCOVERY VERTICAL

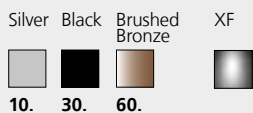

The APP driver can not be controlled by DALI MacAdam 3SDCM  
dimming system and viceversa. Life L90 (6K) 50000h  
CRI =90

IP20

## DISCOVERY VERTICAL

Ø	W	Beam	Flux	CCT
700 mm	40 W	XF	2857 lm	3000K
1000 mm	60 W	XF	4859 lm	3000K
1400 mm	80 W	XF	6762 lm	3000K

PUSH/DALI
Code
<b>19920.10/30/60.A</b>
<b>19930.10/30/60.A</b>
<b>19940.10/30/60.A</b>

PUSH & APP
Code
<b>19920.10/30/60.APP</b>
<b>19930.10/30/60.APP</b>
<b>19940.10/30/60.APP</b>

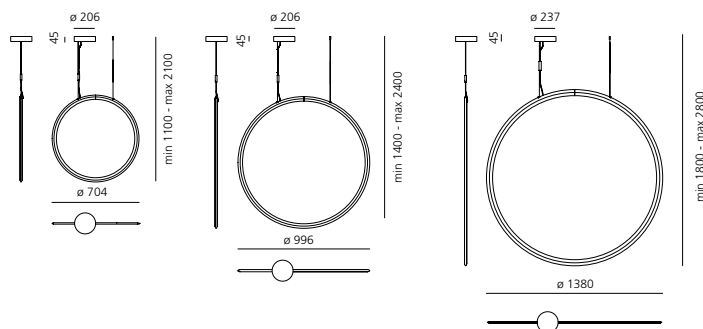

## DISCOVERY VERTICAL TW

**TW**<sup>®</sup>  
Artemide Tunable White

Ø	W	Beam	Flux	CCT
700 mm	50 W	XF	Warm - 3246 lm Cold - 3343 lm	2700K-6500K
1000 mm	71 W	XF	Warm - 4637 lm Cold - 4775 lm	2700K-6500K
1400 mm	84 W	XF	Warm - 5487 lm Cold - 5650 lm	2700K-6500K

DALI DT8
Code
<b>19922.10/30/60.A</b>
<b>19932.10/30/60.A</b>
<b>19942.10/30/60.A</b>

APP
Code
<b>19922.10/30/60.APP</b>
<b>19932.10/30/60.APP</b>
<b>19942.10/30/60.APP</b>



### Optional control devices - BLL wireless switch



Device for switching and controlling Artemide App products.  
Max N.3 inputs for external push buttons.  
Mains power supply required.  
To be installed inside flush mounting boxes or junction boxes.

**DV1080APP**

# DISCOVERY VERTICAL

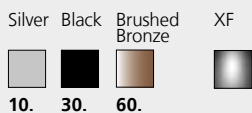

The APP driver can not be controlled by DALI dimming system and viceversa.

MacAdam 3SDCM  
Life L90 (6K) 50000h  
CRI =90

IP20

## DISCOVERY VERTICAL RGBW

Ø	W	Beam	Flux
700 mm	42 W	XF	RGB 871 lm White 1600 lm
1000 mm	59 W	XF	RGB 1107 lm White 2033 lm
1400 mm	79 W	XF	RGB 1453 lm White 2670 lm

DALI
Code
<b>19923.10/30/60.A</b>
<b>19933.10/30/60.A</b>
<b>19943.10/30/60.A</b>

APP
Code
<b>19923.10/30/60.APP</b>
<b>19933.10/30/60.APP</b>
<b>19943.10/30/60.APP</b>

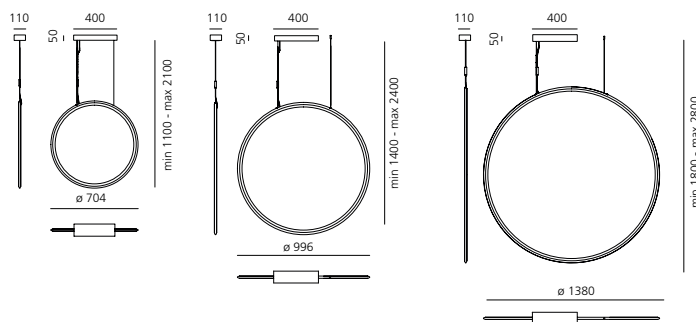
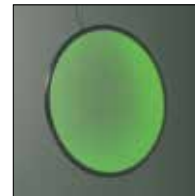

## DISCOVERY VERTICAL INTEGRALIS®

Ø	W	Beam	Flux	CCT
700 mm	42 W	XF	1852 lm	2700K
1000 mm	60 W	XF	2646 lm	2700K
1400 mm	84 W	XF	3704 lm	2700K

APP
Code
<b>19922.10/30/60.IN1APP</b>
<b>19932.10/30/60.IN1APP</b>
<b>19942.10/30/60.IN1APP</b>

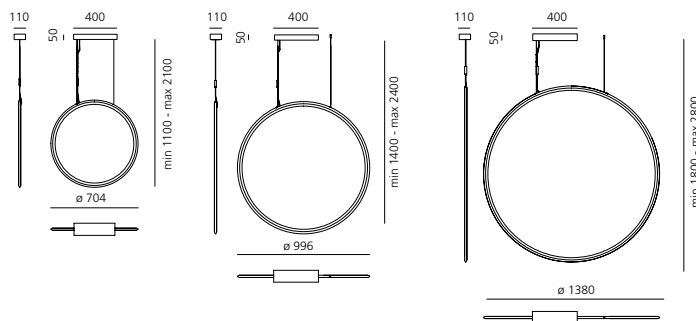





# DISCOVERY WALL

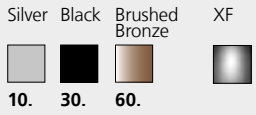

The APP driver can not be controlled by DALI dimming system and viceversa.

MacAdam 3SDCM  
Life L90 (6K) 50000h  
CRI =90

IP20

## DISCOVERY WALL

				<b>PUSH</b>
W	Beam	Flux	CCT	Code
40 W	XF	2857 lm	3000K	<b>19980.10/30/60.A</b>

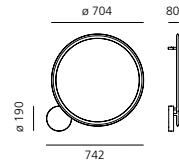

### Optional control devices - BLL wireless switch



Device for switching and controlling Artemide App products.  
Max N.3 inputs for external push buttons.  
Mains power supply required.  
To be installed inside flush mounting boxes or junction boxes.

**DV1080APP**



# Discovery Dialogue

Born from a dynamic dialogue between light, space and our perception. An unexpected touch emerges within this optical algorithm, explored in various forms and sizes. A diagonal cut, reminiscent of Fontana's canvases, disrupts the surface by splitting it in half. This intervention makes it possible to handle light in two ways. It breaks the uniformity of Discovery's surface by dividing it into two different light emissions, each perfectly calibrated in its light characteristics.

The cut disrupts the sequence of micro-incisions that extract light, creating a new balance between two types of light, whether similar or contrasting. The space that opens up between the two parts sparks a dialogue, allowing the emissions from the frame's profile to freely separate and vary independently.



# DISCOVERY DIALOGUE

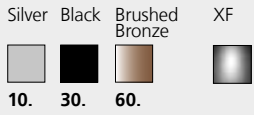

The APP driver can not be controlled by DALI dimming system and viceversa.

MacAdam 3SDCM  
Life L90 (6K) 50000h  
CRI =90

IP20

## DISCOVERY DIALOGUE RGBW

W	Beam	Flux
RGB 13 W	XF	RGB 317 lm
White 23 W		White 738 lm

**APP**  
**Code**  
**20320.10/30/60.APP**

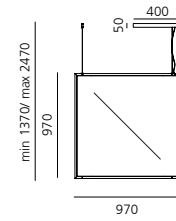
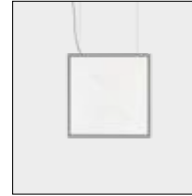

Vertical Installation

## Optional control devices - BLL wireless switch



Device for switching and controlling Artemide App products.  
Max N.3 inputs for external push buttons.  
Mains power supply required.  
To be installed inside flush mounting boxes or junction boxes.

**DV1080APP**

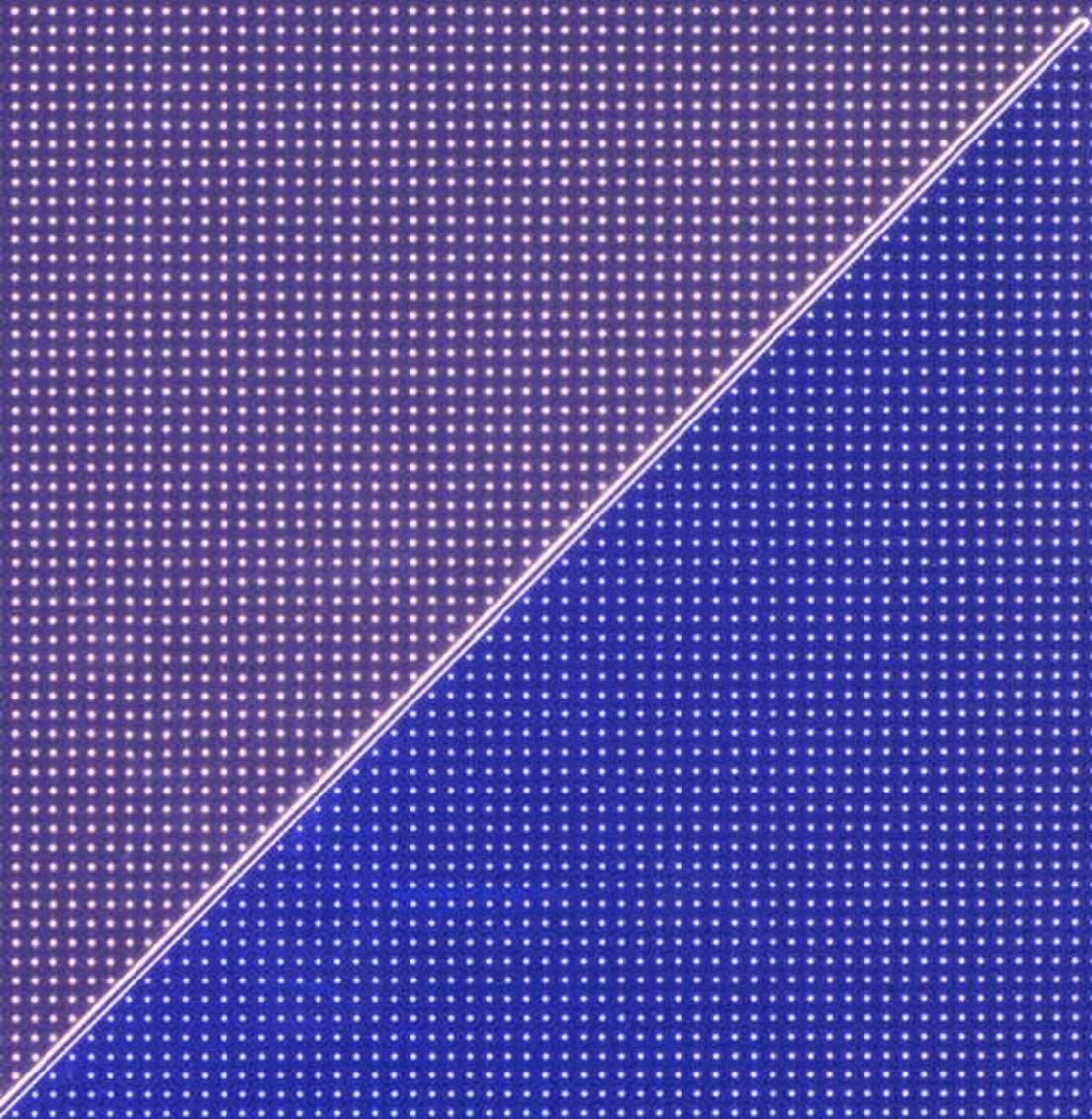



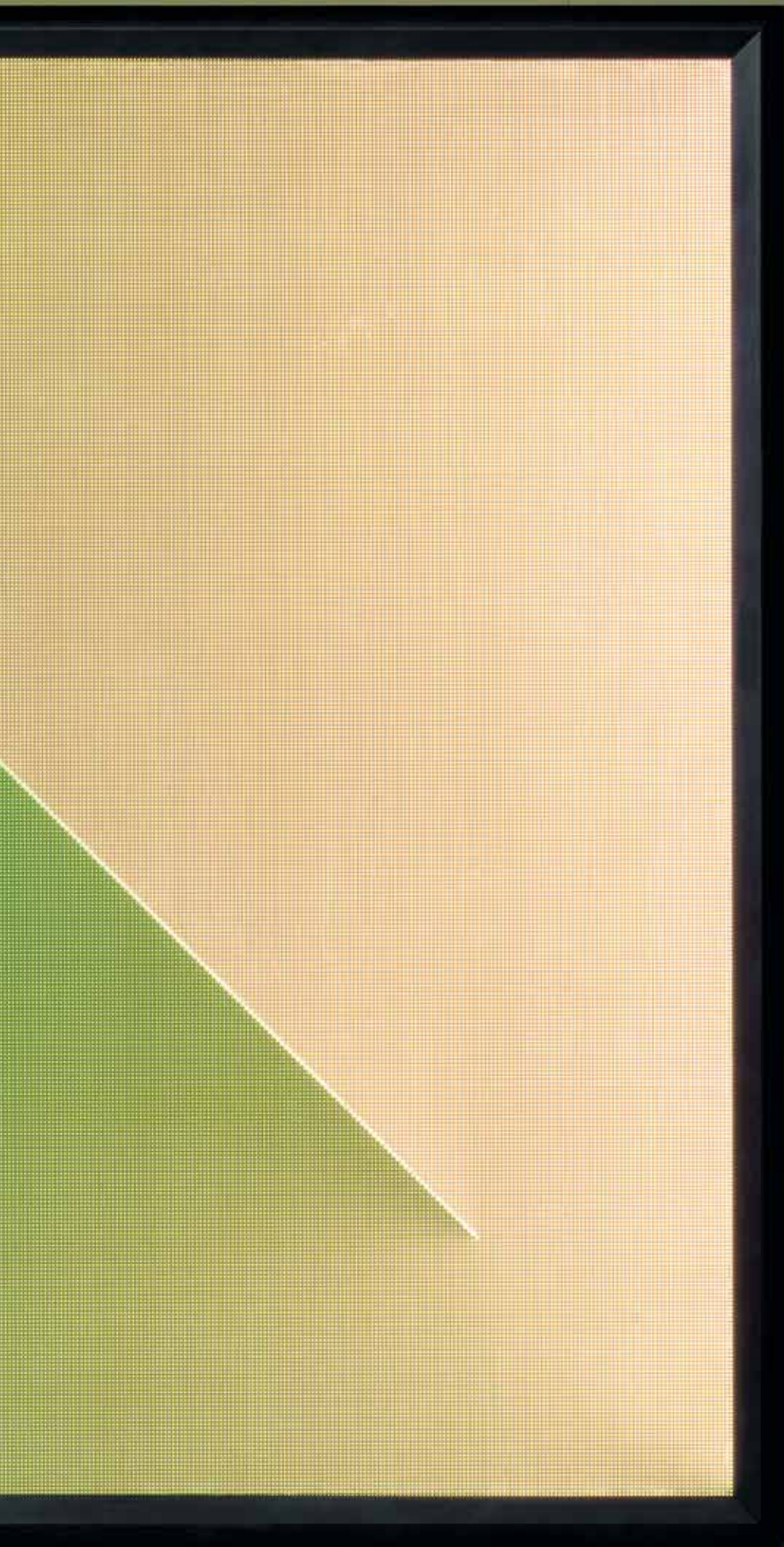

# Discovery Space

Discovery Space is available in two versions, Square 900x900 and Rectangular 750x1500 with the White, TW and RGBW emissions.

Through the use of two support cables, Discovery Space can be installed both vertically and horizontally, giving the possibility to create different wings that shape the spaces through presence and absence given by its different levels of transparency.



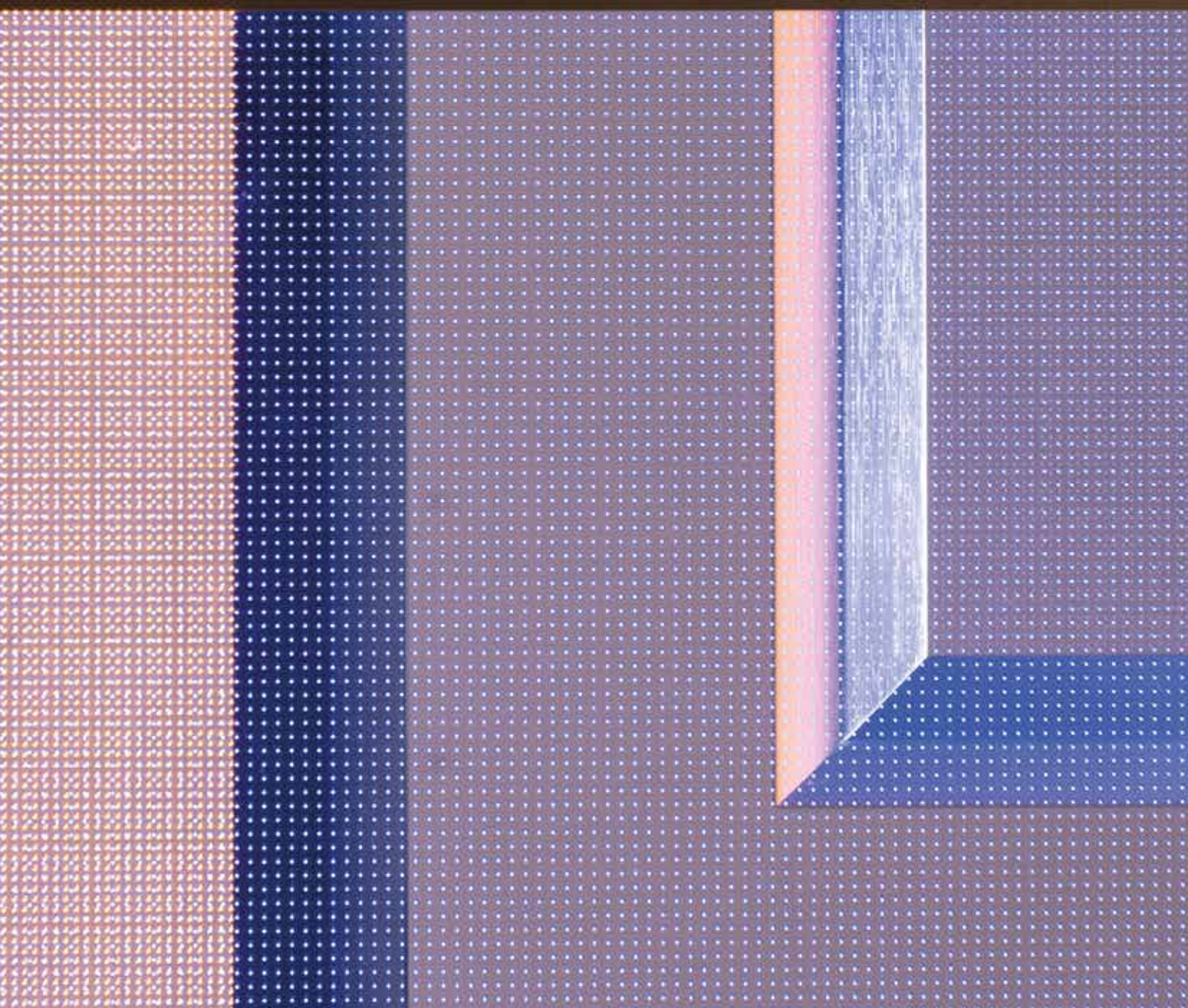







**Total flexibility  
in the space**







# DISCOVERY SPACE

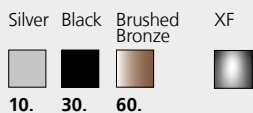

The APP driver can not be controlled by DALI dimming system and viceversa.

MacAdam 3SDCM  
Life L90 (6K) 50000h  
CRI =90

IP20

## DISCOVERY SPACE SQUARE

W	Beam	Flux	CCT
34 W	XF	1955 lm	3000K

PUSH/DALI Code
<b>20040.10/30/60.A</b>

PUSH & APP Code
<b>20040.10/30/60.APP</b>

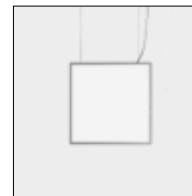

## DISCOVERY SPACE SQUARE TW



W	Beam	Flux	CCT
44 W	XF	Warm - 2579 lm Cold - 2739 lm	2700K-6500K

DALI DT8 Code
<b>20000.10/30/60.A</b>

APP Code
<b>20000.10/30/60.APP</b>

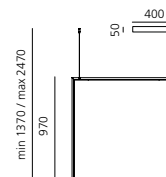

970

Vertical Installation

## DISCOVERY SPACE SQUARE RGBW

W	Beam	Flux
36 W	XF	RGB 621 lm White 1087 lm

DALI Code
<b>20010.10/30/60.A</b>

APP Code
<b>20010.10/30/60.APP</b>

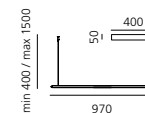

min 400 / max 1500

970

Horizontal Installation

## DISCOVERY SPACE SQUARE INTEGRALIS®

W	Beam	Flux	CCT
42 W	XF	1852 lm	2700K

APP Code
<b>20000.10/30/60.INAPP</b>

### Optional control devices - BLL wireless switch



Device for switching and controlling Artemide App products.  
Max N.3 inputs for external push buttons.  
Mains power supply required.  
To be installed inside flush mounting boxes or junction boxes.

**DV1080APP**

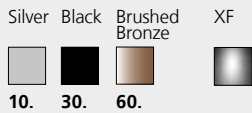

The APP driver can not be controlled by DALI dimming system and viceversa.

MacAdam 3SDCM  
Life L90 (6K) 50000h  
CRI =90

IP20

### DISCOVERY SPACE RECTANGULAR

W	Beam	Flux	CCT
52 W	XF	4002 lm	3000K

PUSH/DALI
Code <b>20050.10/30/60.A</b>

PUSH & APP
Code <b>20050.10/30/60.APP</b>

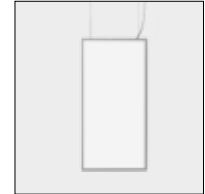

### DISCOVERY SPACE RECTANGULAR TW



W	Beam	Flux	CCT
62 W	XF	Warm - 3554 lm Cold - 3775 lm	2700K-6500K

DALI DT8
Code <b>20020.10/30/60.A</b>

APP
Code <b>20020.10/30/60.APP</b>

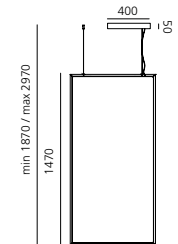

### DISCOVERY SPACE RECTANGULAR RGBW

W	Beam	Flux
54 W	XF	RGB 969 lm White 1695 lm

DALI
Code <b>20030.10/30/60.A</b>

APP
Code <b>20030.10/30/60.APP</b>

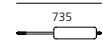

Vertical Installation

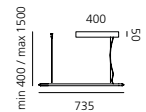

Horizontal Installation

### DISCOVERY SPACE RECTANGULAR INTEGRALIS®

W	Beam	Flux	CCT
63 W	XF	2778 lm	2700K

APP
Code <b>20020.10/30/60.INAPP</b>

### Optional control devices - BLL wireless switch



Device for switching and controlling Artemide App products.  
Max N.3 inputs for external push buttons.  
Mains power supply required.  
To be installed inside flush mounting boxes or junction boxes.

**DV1080APP**

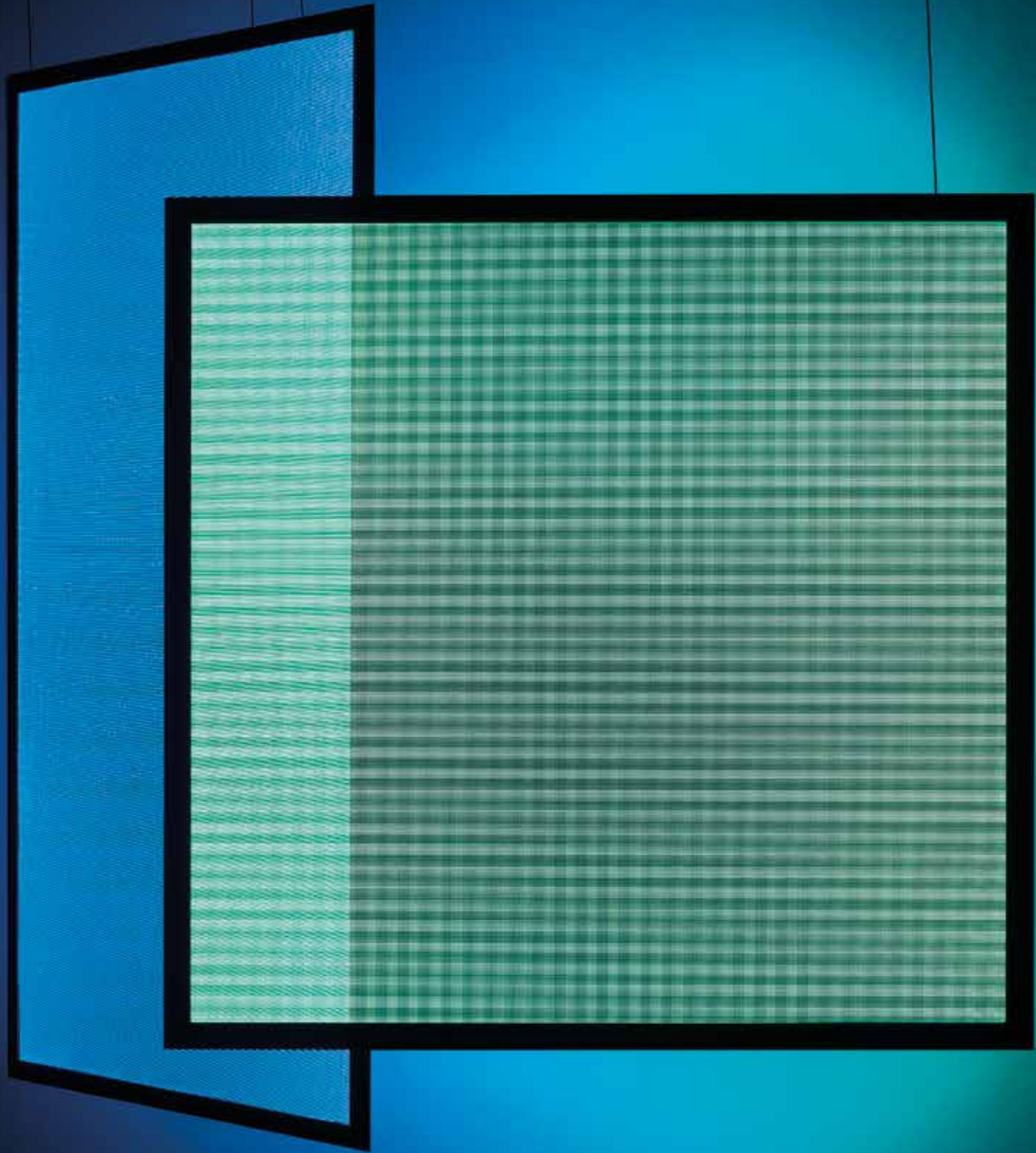











# Discovery Spot

The Discovery square and rectangular versions become Discovery Spot with the inclusion of the Vector Spot projector, designed by Carlotta de Bevilacqua.

It fits into a circular hole recreated in the emitting surface to allow its different orientations.

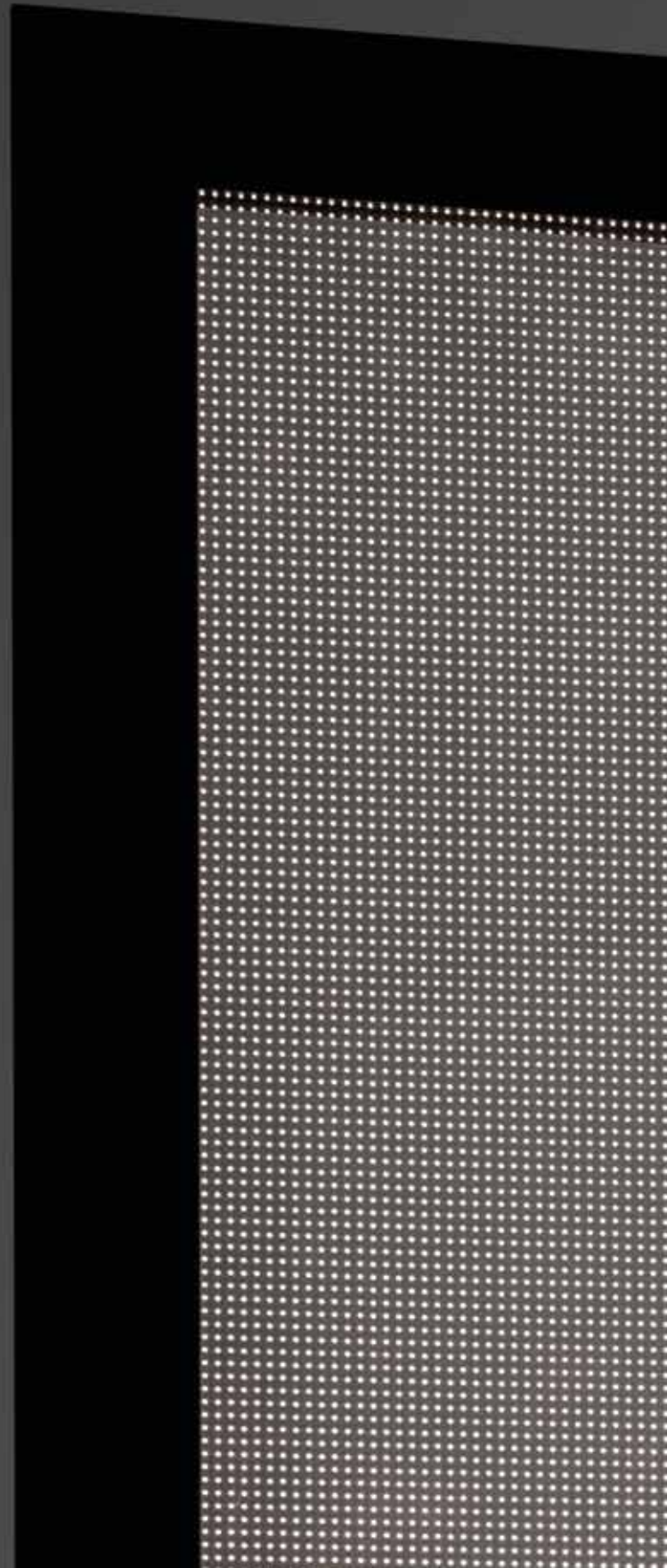



# DISCOVERY SPACE SPOT

Black



30.

F XF



The APP driver can not be controlled by DALI.

MacAdam 3SDCM  
Life L90 (6k) 50000h  
CRI =80

\*Vector 55 spot provided with 2 optic  
(16° and 22°).

IP20

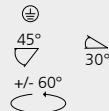

## DISCOVERY SPACE SQUARE SPOT TW

W	Beam	Flux	CCT
44 W	XF	Warm - 2579 lm Cold - 2739 lm	2700K-6500K
18W (spot*)F (16°)		1619 lm	3000K
18W (spot*)F (22°)		1655 lm	3000K



**APP**  
Code  
**2030030APP**

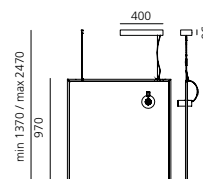
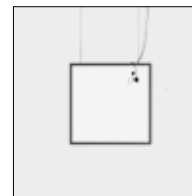

970

Vertical Installation

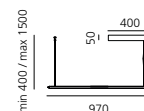

Horizontal Installation

## DISCOVERY SPACE RECTANGULAR SPOT TW

W	Beam	Flux	CCT
62 W	XF	Warm - 3554 lm Cold - 3775 lm	2700K-6500K
18W (spot*)F (16°)		1619 lm	3000K
18W (spot*)F (22°)		1655 lm	3000K



**APP**  
Code  
**2031030APP**

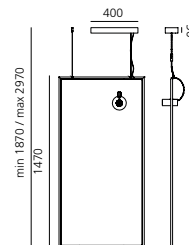
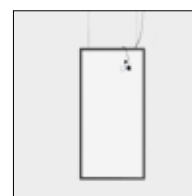

735

Vertical Installation

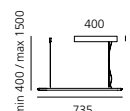

Horizontal Installation

### Optional control devices - BLL wireless switch



Device for switching and controlling Artemide App products.  
Max N.3 inputs for external push buttons.  
Mains power supply required.  
To be installed inside flush mounting boxes or junction boxes.

**DV1080APP**







# Discovery Floor

Discovery floor is brought to the essential. The technological innovation applied to the emitting surface enclosed by a black frame becomes the only element that constitutes this floor lamp. The dimensions are re-proportioned with respect to the suspended versions so that it can fit perfectly into any environment simply by leaning freely against the walls in an inclined position.









# DISCOVERY FLOOR

Black



30.

XF



The APP driver can not be controlled by DALI dimming system and viceversa.

MacAdam 3SDCM  
Life L90 (6K) 50000h  
CRI =80

IP20



## DISCOVERY FLOOR TW



Artemide Tunable White

W	Beam	Flux	CCT
61 W	XF	Warm - 3805 lm Cold - 4054 lm	2700K-6500K

PUSH & APP
Code
<b>20400.30.APP</b>

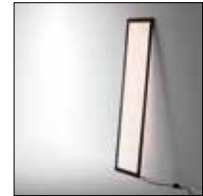

## DISCOVERY FLOOR RGBW

W	Beam	Flux
56 W	XF	RGB 1036 lm White 1817 lm

PUSH & APP
Code
<b>20410.30.APP</b>

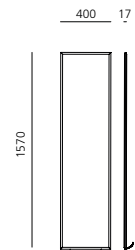

## DISCOVERY FLOOR INTEGRALIS®

W	Beam	Flux	CCT
67 W	XF	2972 lm	2700K

PUSH & APP
Code
<b>20400.30.IN1APP</b>

### Optional control devices - BLL wireless switch



Device for switching and controlling Artemide App products.  
Max N.3 inputs for external push buttons.  
Mains power supply required.  
To be installed inside flush mounting boxes or junction boxes.

**DV1080APP**









la Stampa

Press Room

la Stampa

Press Room

la Stampa



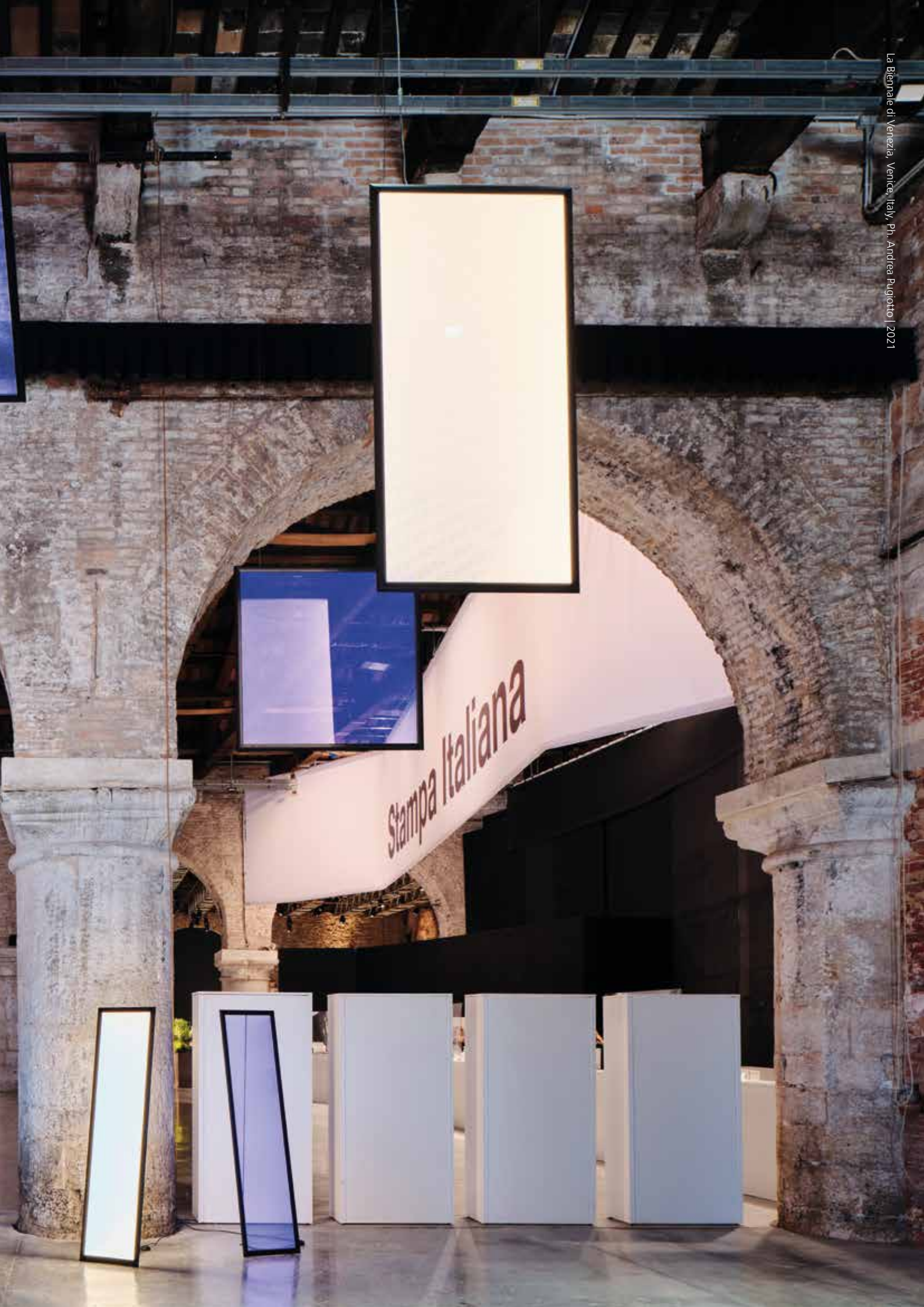





















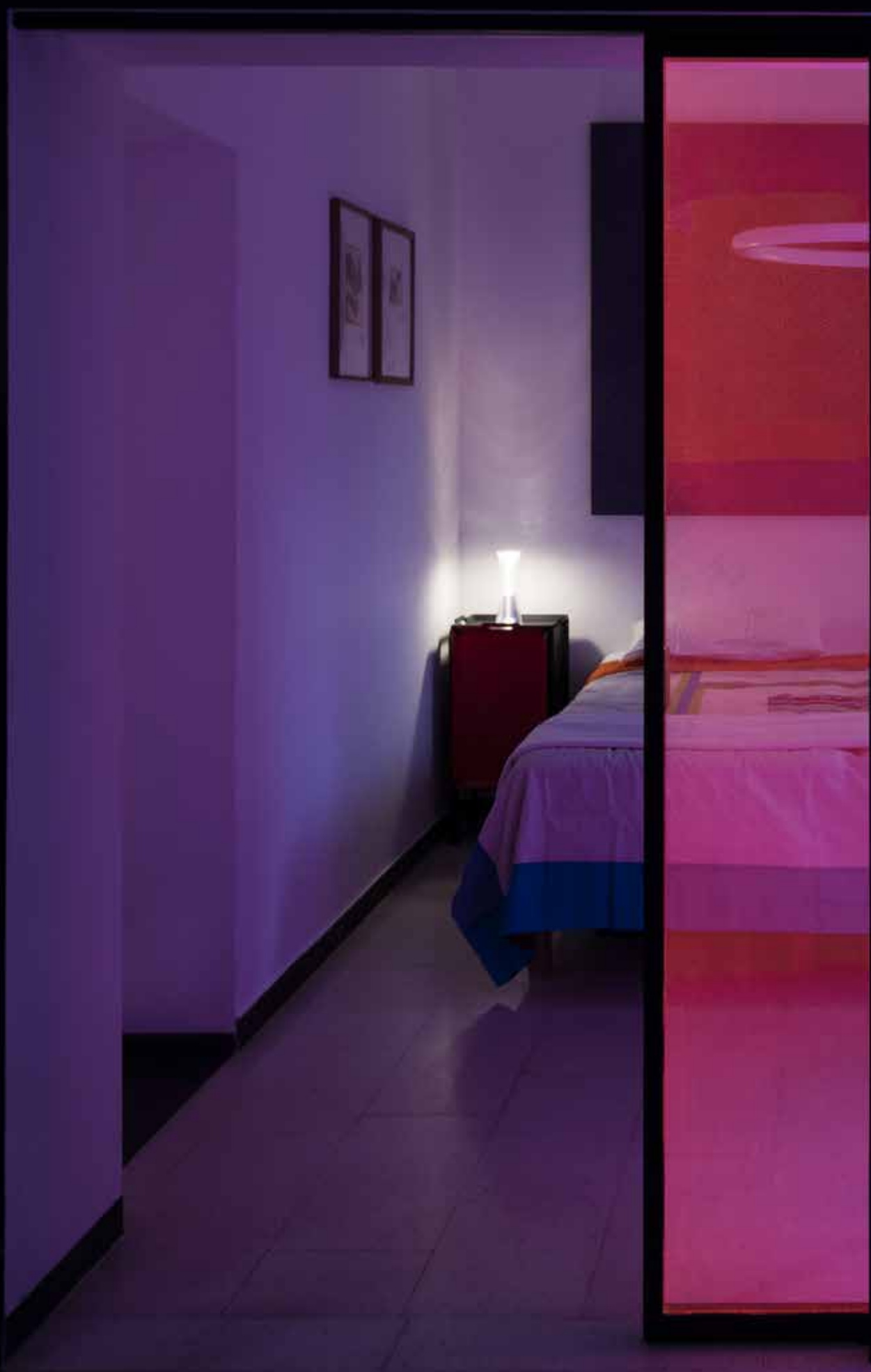



## **Discovery** **is INTEGRALIS®**

INTEGRALIS® is an innovative light, perfectly integrated into the products of the Artemide collections, that sanitizes spaces.

INTEGRALIS® combines sanitizing efficacy with luminous performance and design beauty.

It also integrates itself in both the environments and moments of life by interpreting the rhythms and needs of mankind.

INTEGRALIS® is managed by Artemide App, a digital interaction system accessible to all.

INTEGRALIS® was born from Artemide's scientific and technological research and humanistic and social vision.

INTEGRALIS® is a project that associates and integrates the visible and invisible spectral range in an innovative formula capable of regenerating the environmental qualities of the space.

PATENT PENDING

# INTEGRALIS®

A light for a safe environment



Discover INTEGRALIS® collection on [artemide.com](https://www.artemide.com)



## Discovery Family is compatible with **Artemide App**

Artemide App is a user-friendly and intuitive interface used to control individual products, groups of appliances and lighting scenarios. It is a tool that can be associated with several products from both the Design and the Architectural Catalogues.





Download Artemide App  
and find more information on  
[artemide.com](https://www.artemide.com)

## Headquarters

### Artemide S.p.A.

Via Bergamo, 18  
20010 Pregnana Milanese (MI), Italy  
Tel. +39 02 93518.1  
Tel. +39 02 93526.1  
Numero verde 800 834 093  
(from Italy only)  
info@artemide.com  
artemide.com

## Communication and Marketing Department

Via Canova, 34  
20145 Milan (MI), Italy  
Tel. +39 02.349611  
marketing@artemide.com  
artemide.com

### Artemide S.p.A.

si riserva la facoltà di modificare, in qualunque momento e senza preavviso, le caratteristiche tecniche degli elementi illustrati nel presente catalogo.

### Artemide S.p.A.

reserves the right to change, at any time and without prior warning, the technical specifications of any product illustrated in this catalogue.

### Artemide S.p.A.

se réserve le droit de modifier, à n'importe quel moment et sans préavis, les caractéristiques techniques des éléments illustrés dans ce catalogue.

### Artemide S.p.A.

behält sich das Recht vor jederzeit und ohne Ankündigung die technischen Daten der im Katalog abgebildeten Produkte zu ändern.

### Artemide S.p.A.

se reserva la facultad de modificar, en cualquier y sin aviso previo, las características técnicas de los elementos ilustrados en el presente catálogo.



ISO 9001:2015



ISO 14001:2015



ISO 45001:2018